

# World War II Coloring Book Level C

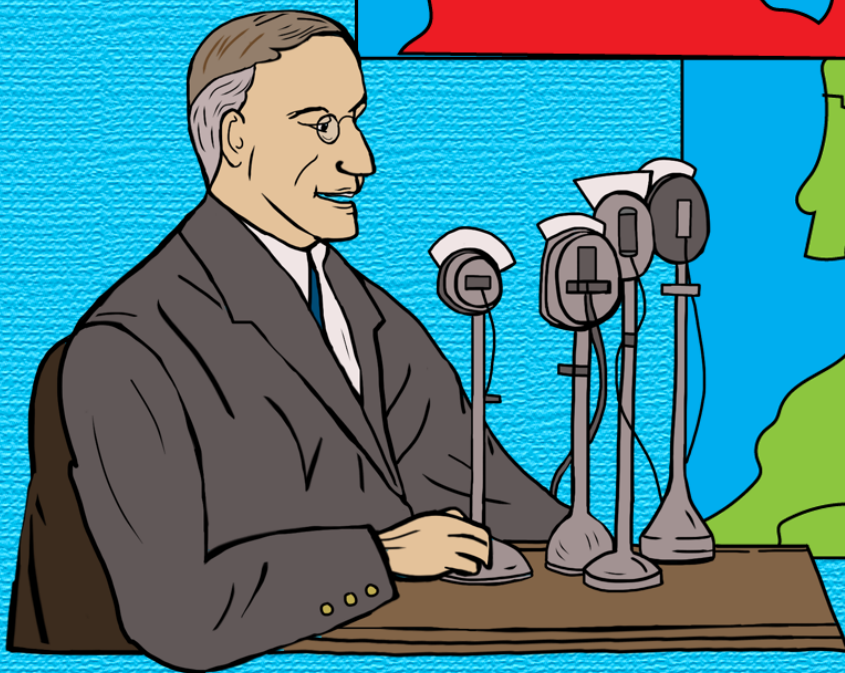

**By Bonnie Rose Hudson**

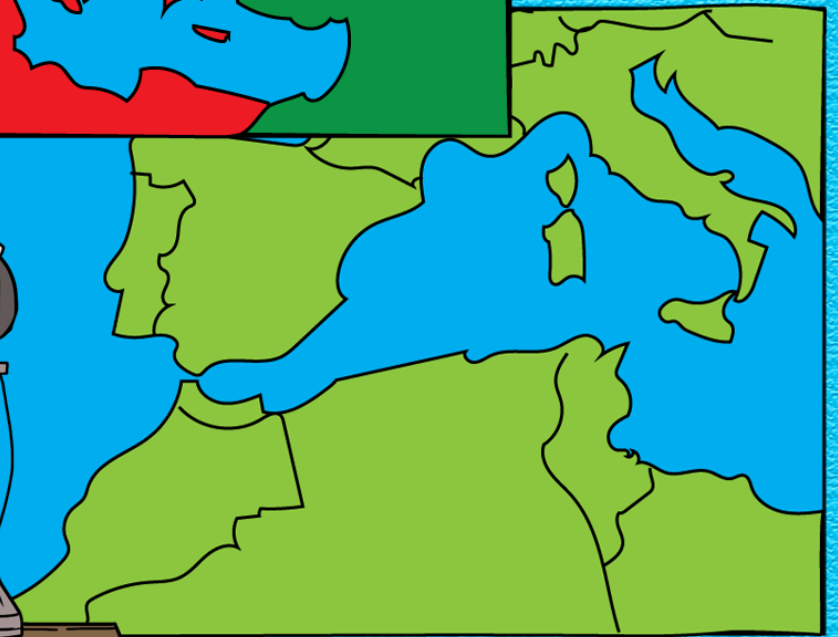
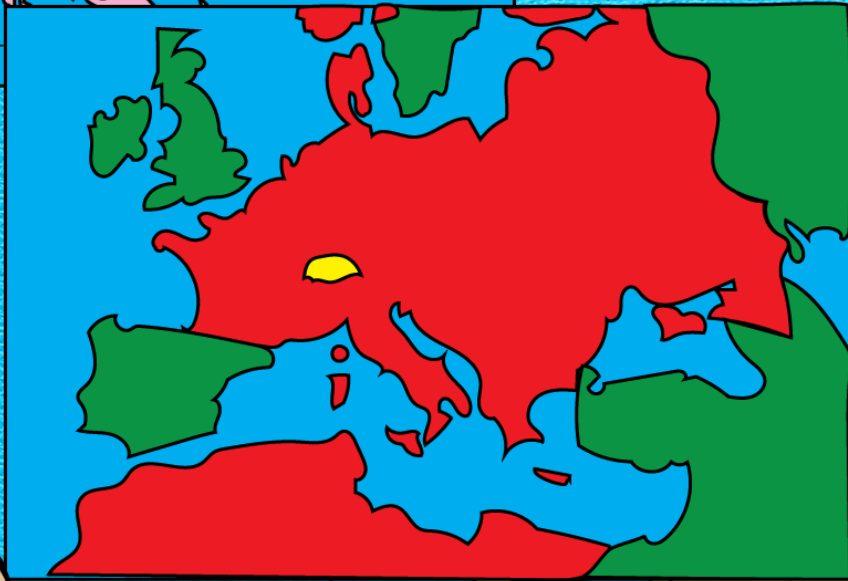
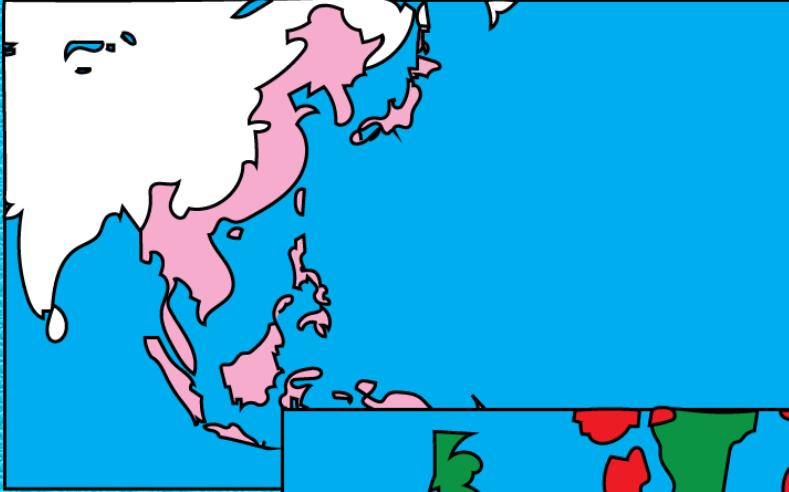
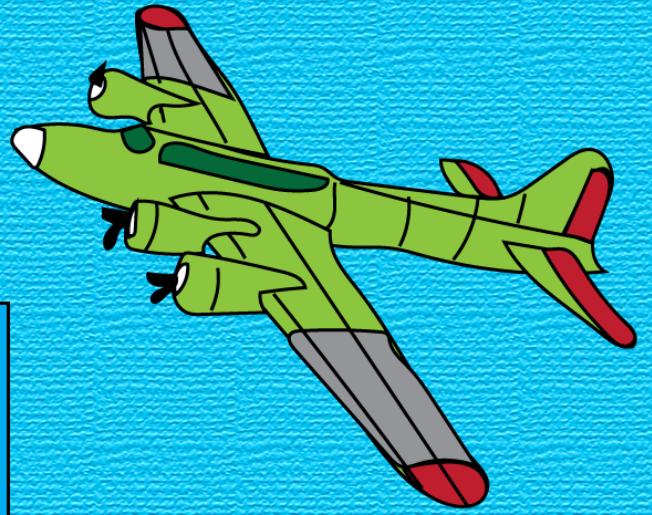

Copyright © 2017 by Bonnie Rose Hudson



Graphics used courtesy of [Ninja Mom Designs](#), [Dandy Doodles](#), [EduClips](#), and [Teachers Resource Force](#)

All Rights Reserved. This book may not be reproduced or transmitted by any means, including graphic, electronic, or mechanical, without the express written consent of the author except in the case of brief quotations embodied in critical articles and reviews and those uses expressly described in the following Terms of Use. You are welcome to link back to the author's website, <http://writebonnierose.com>, but may not link directly to the PDF file. You may not alter this work, sell or distribute it in any way, host this file on your own website, or upload it to a shared website.

Terms of Use: For use by a family, this unit can be printed and copied as many times as needed. Classroom teachers may reproduce one copy for each student in his or her class. Members of co-ops or workshops may reproduce one copy for up to fifteen children. This material cannot be resold or used in any way for commercial purposes. Please contact the publisher with any questions.



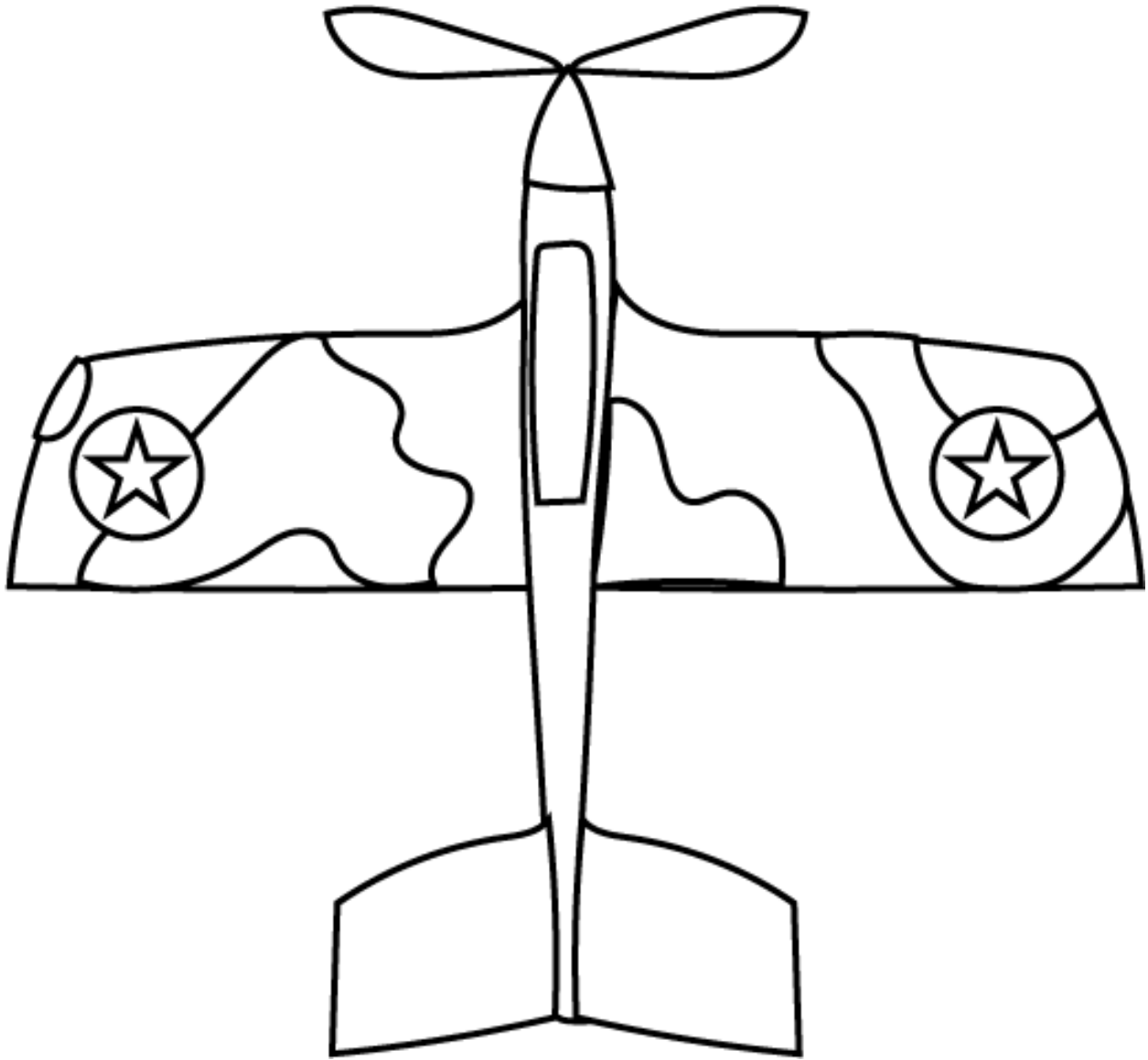

The U.S. Army Air  
Forces joined the other  
Allies in the air fight  
against Germany.

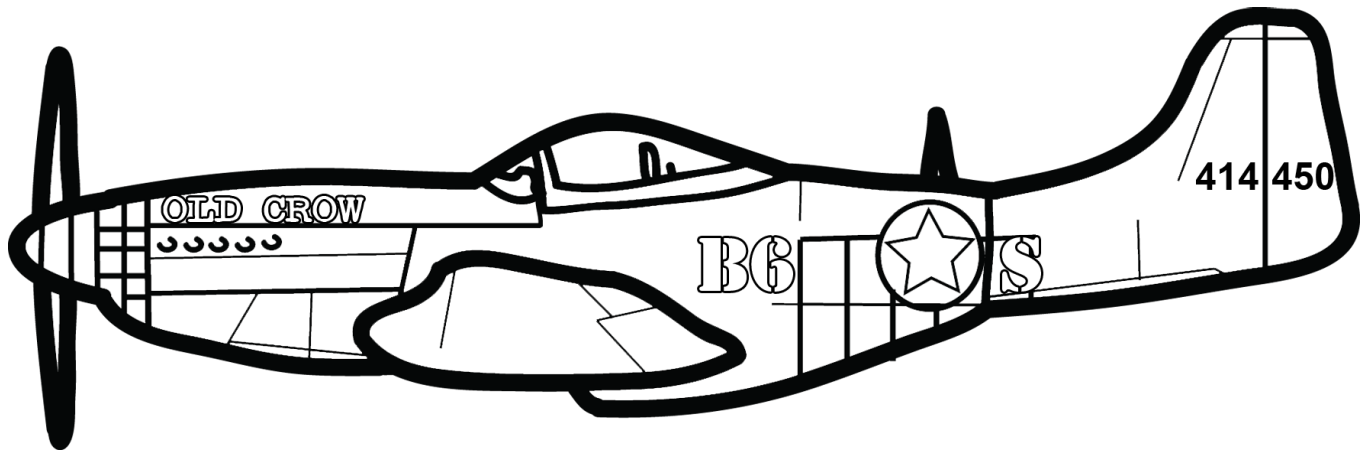

*Allied planes played  
a major part  
in the war effort.*

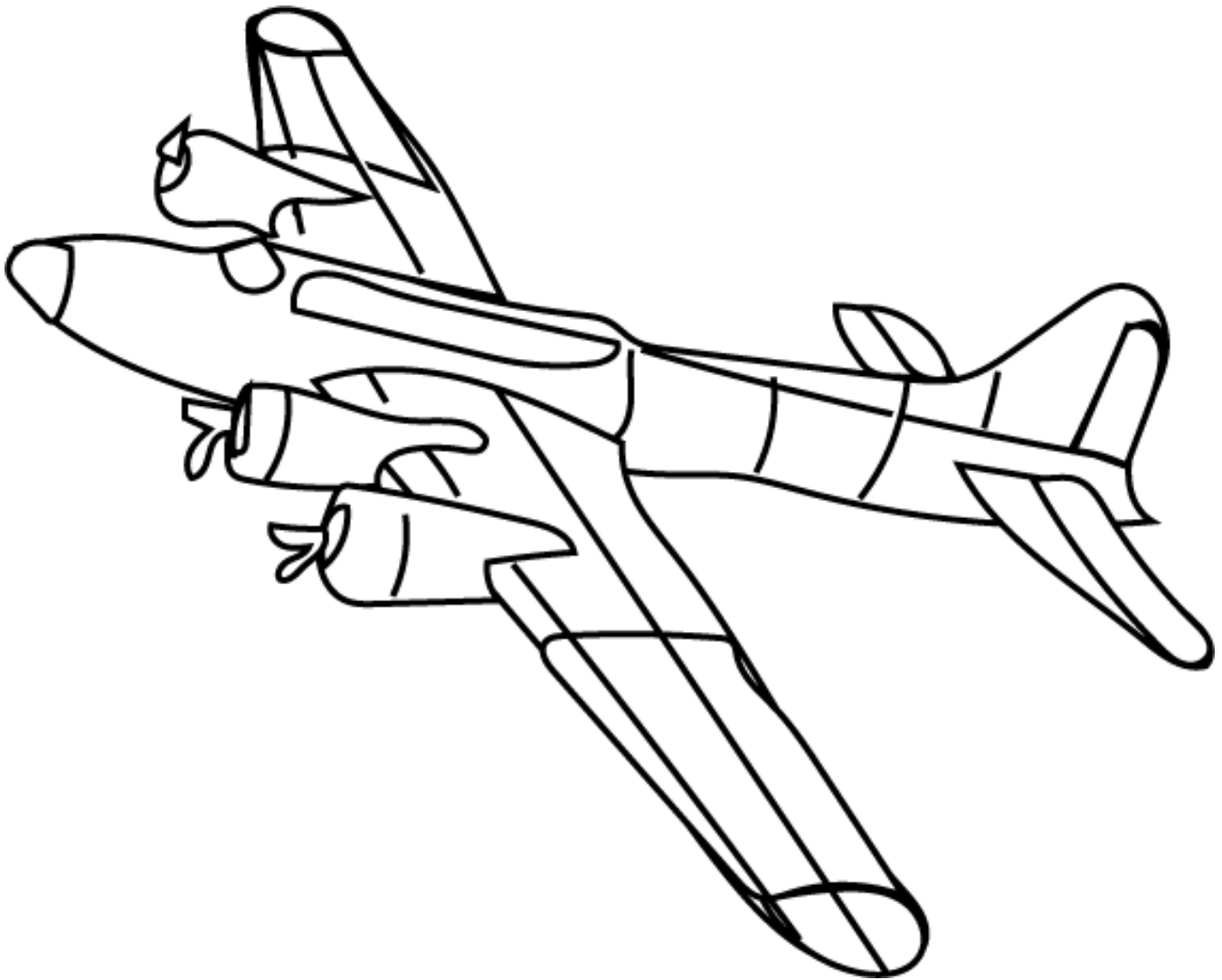

B-17's were also

called Flying Fortresses.

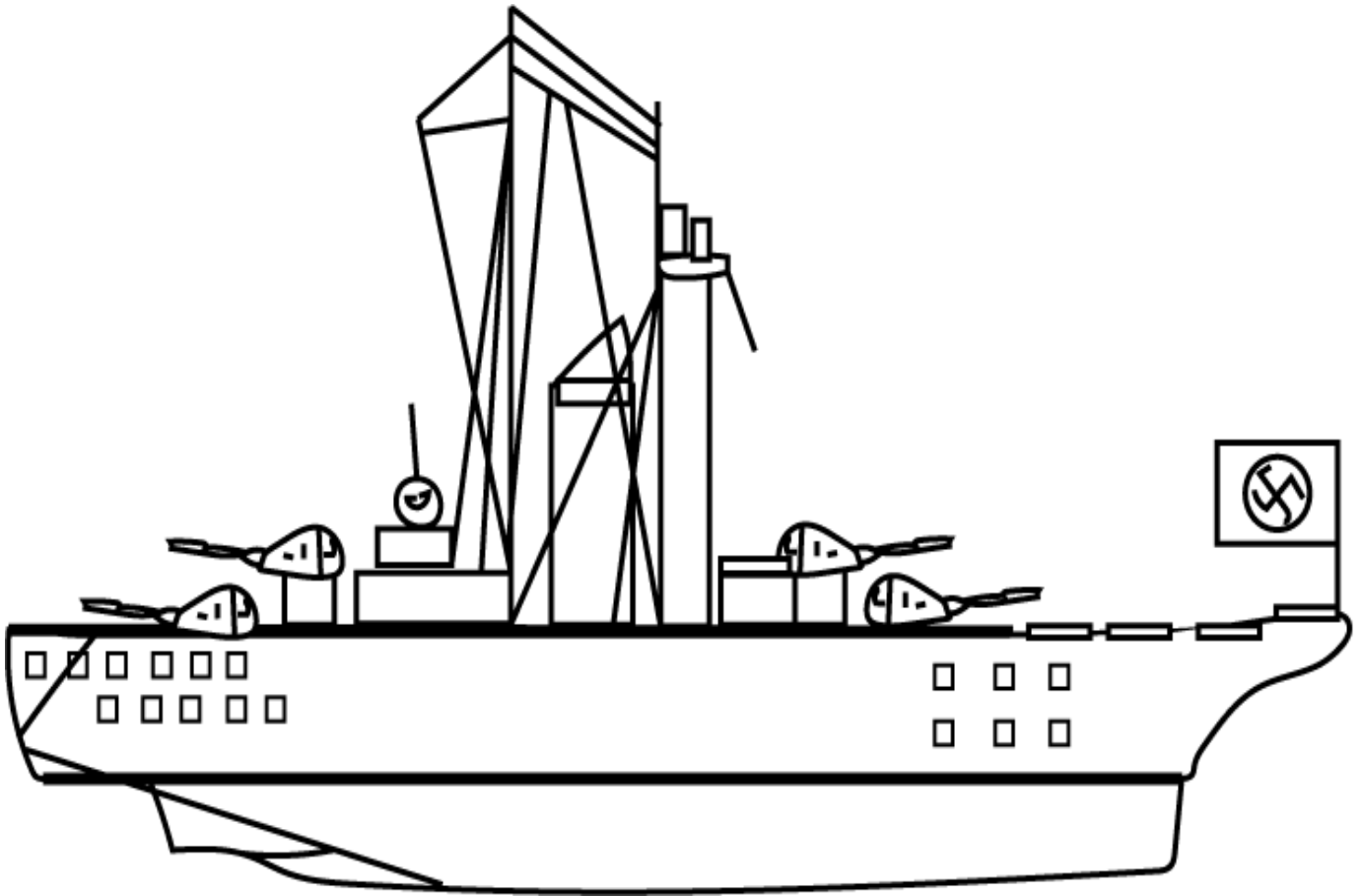

The British sank the

German battleship

“Bismarck,” which greatly

helped the Allied cause.

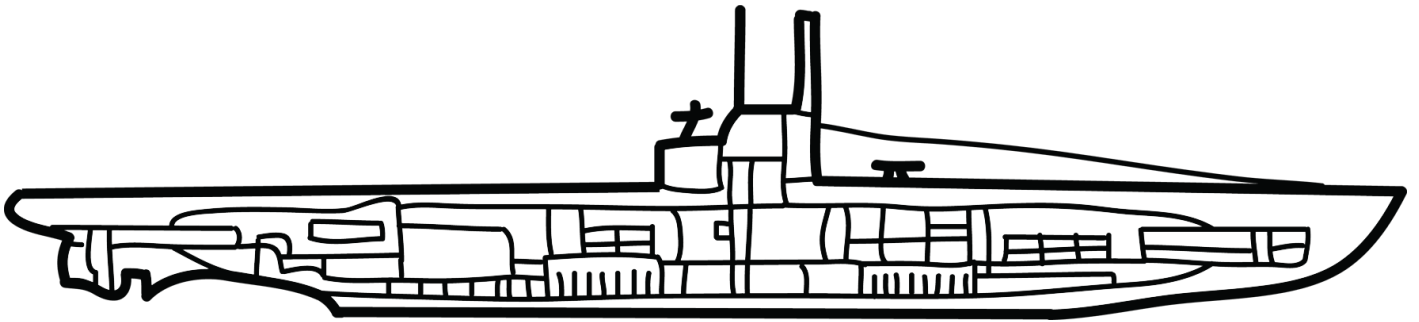
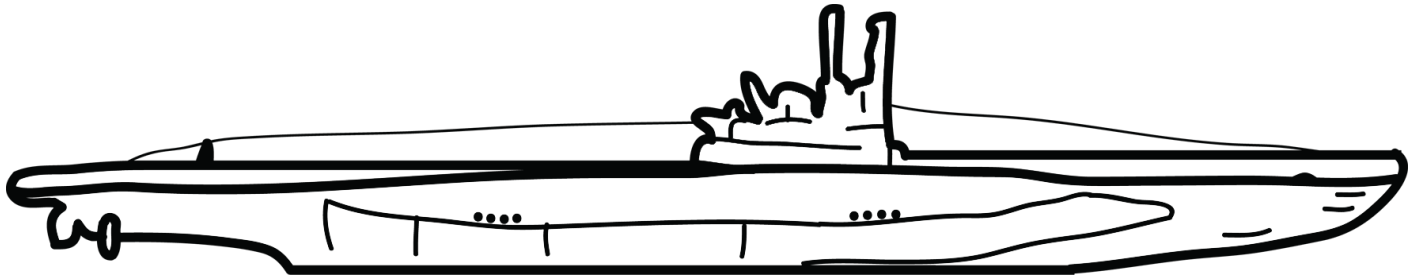

This is a German

U-boat. The bottom

picture shows how

it looked inside.

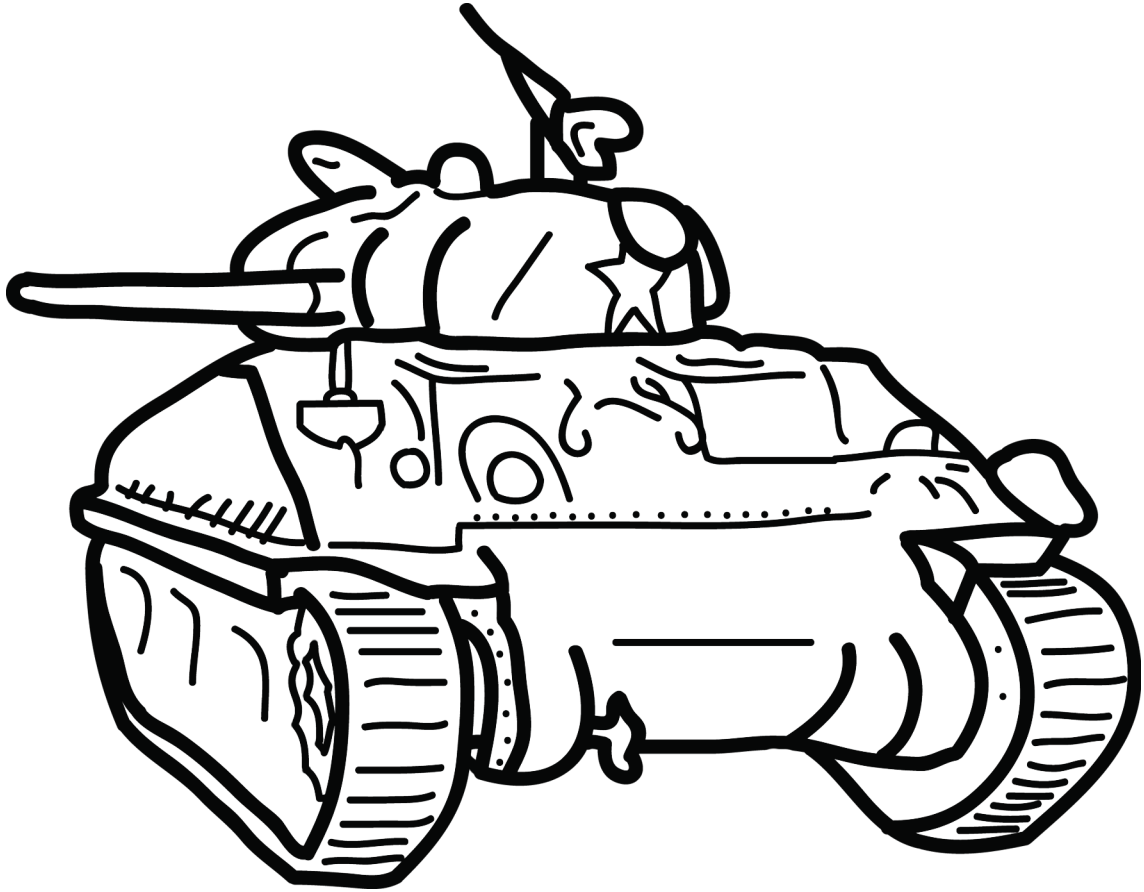

The Sherman tank  
was first used in  
combat by British forces  
in Egypt in 1942.



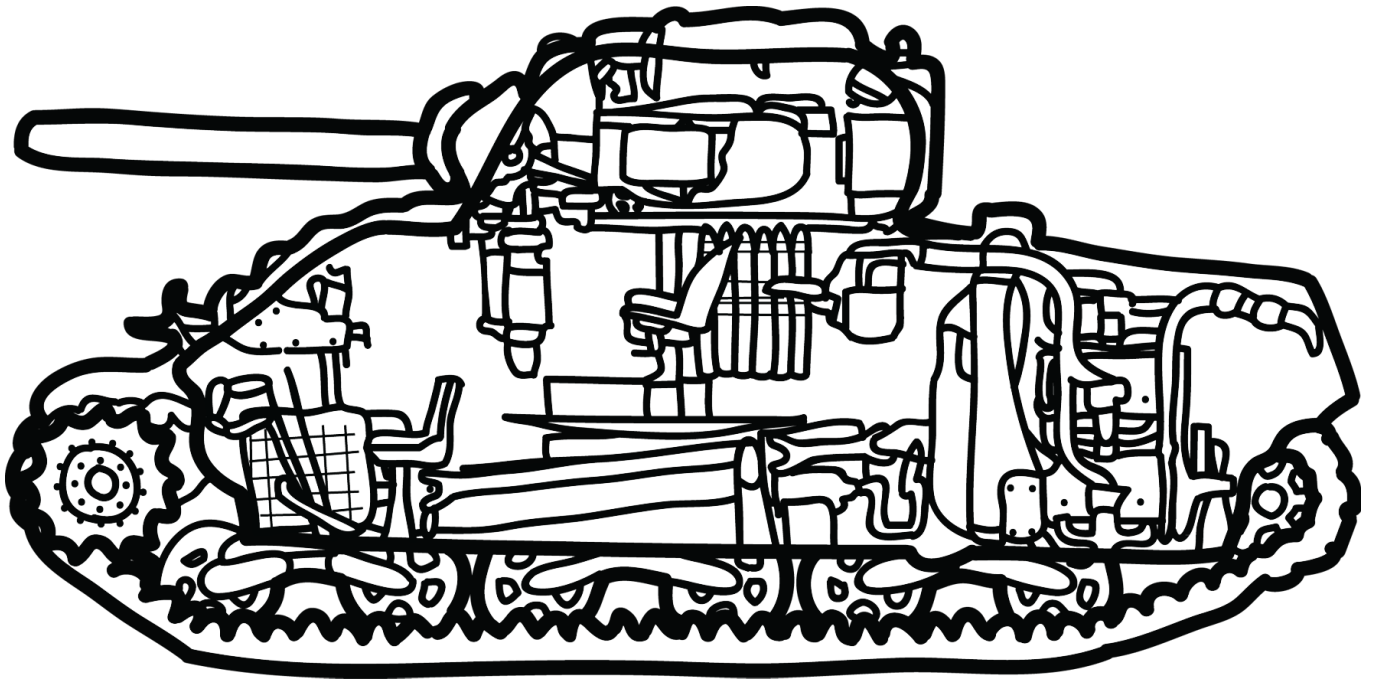

This picture allows  
you to see the inside  
of the Sherman tank.

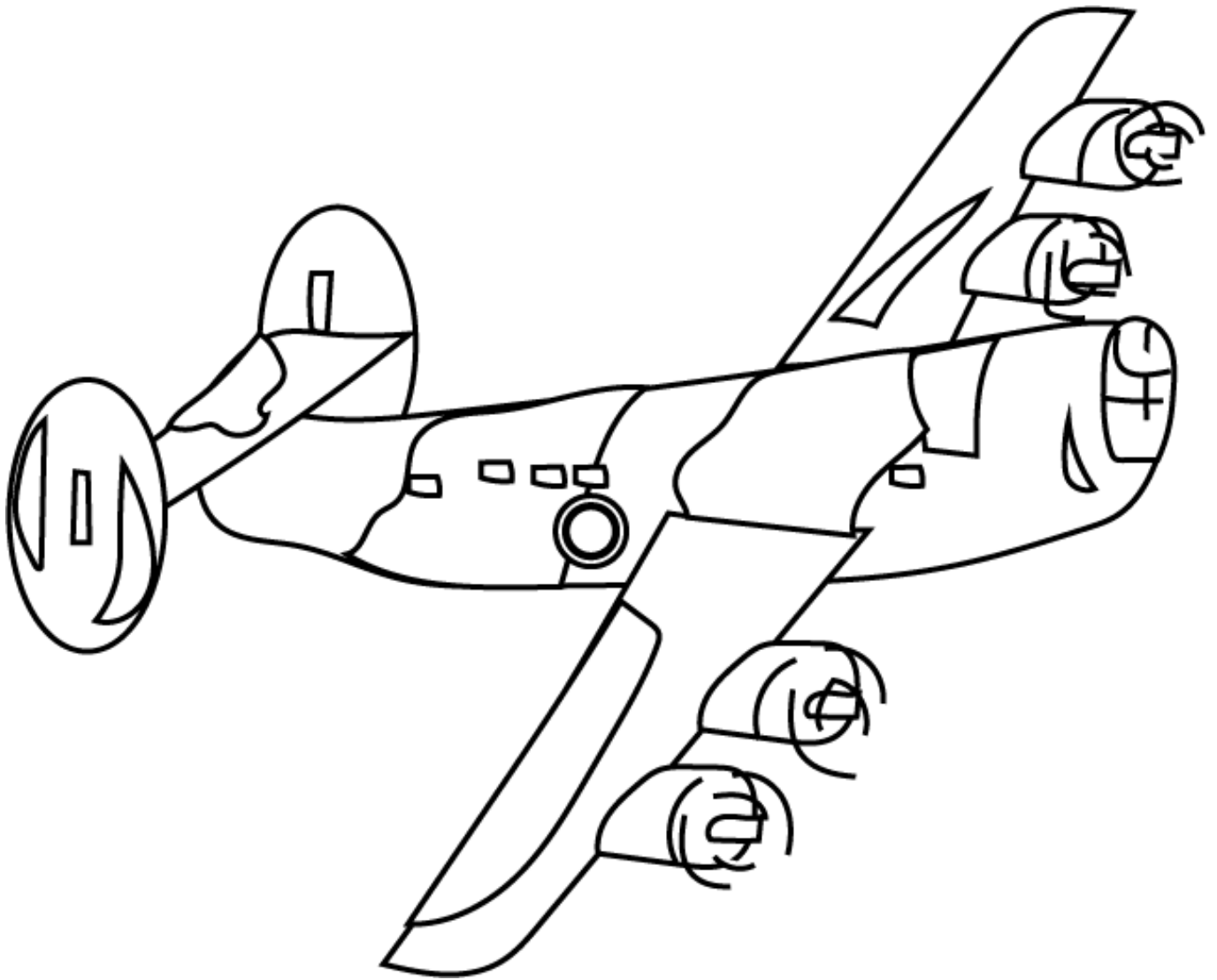

British planes attacked  
Germany to try  
and stop the war.

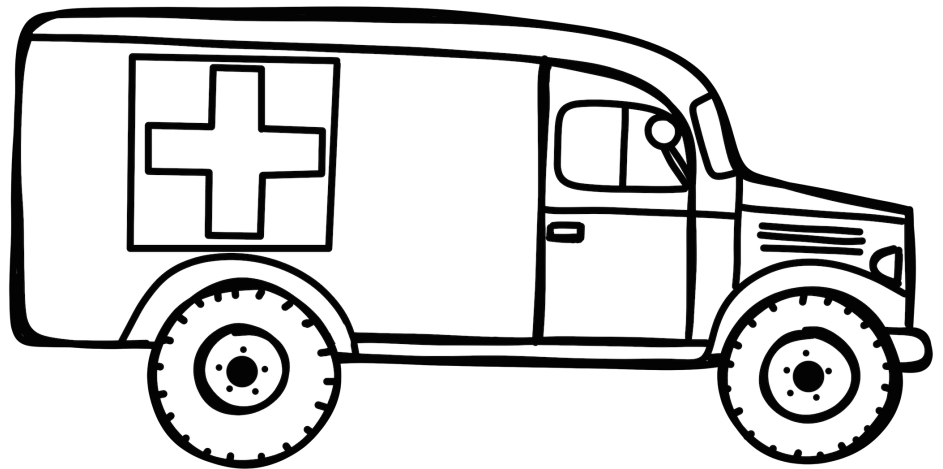
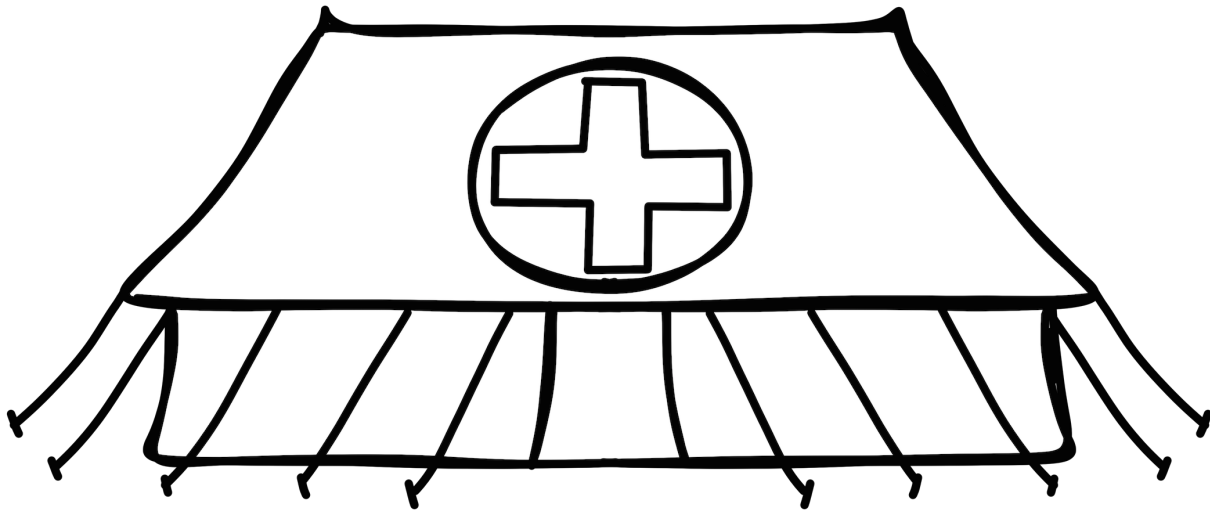

Ambulances brought the  
wounded to field hospitals  
where doctors and nurses  
could treat them.

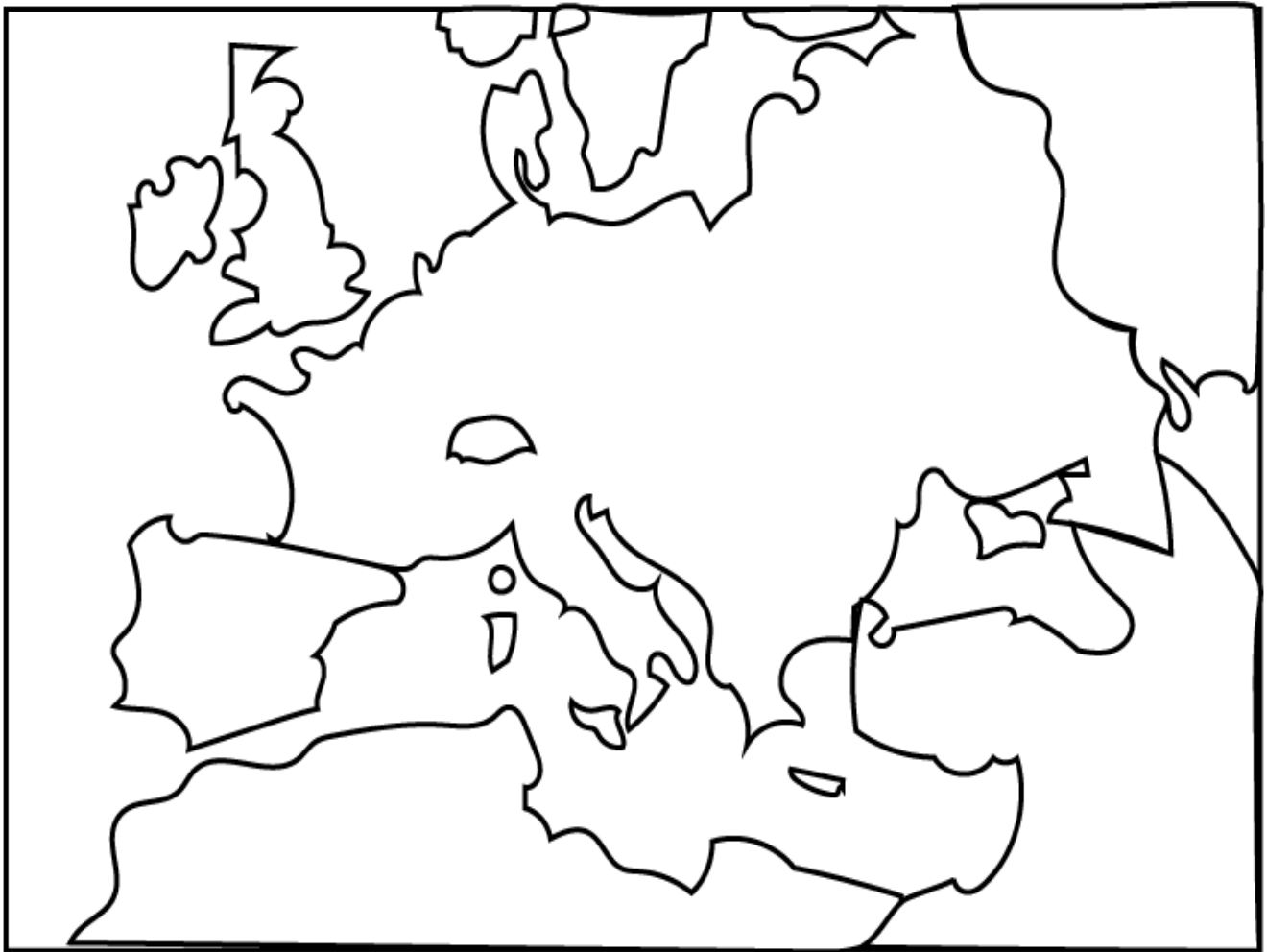

*This map shows the  
European theater  
of the war.*

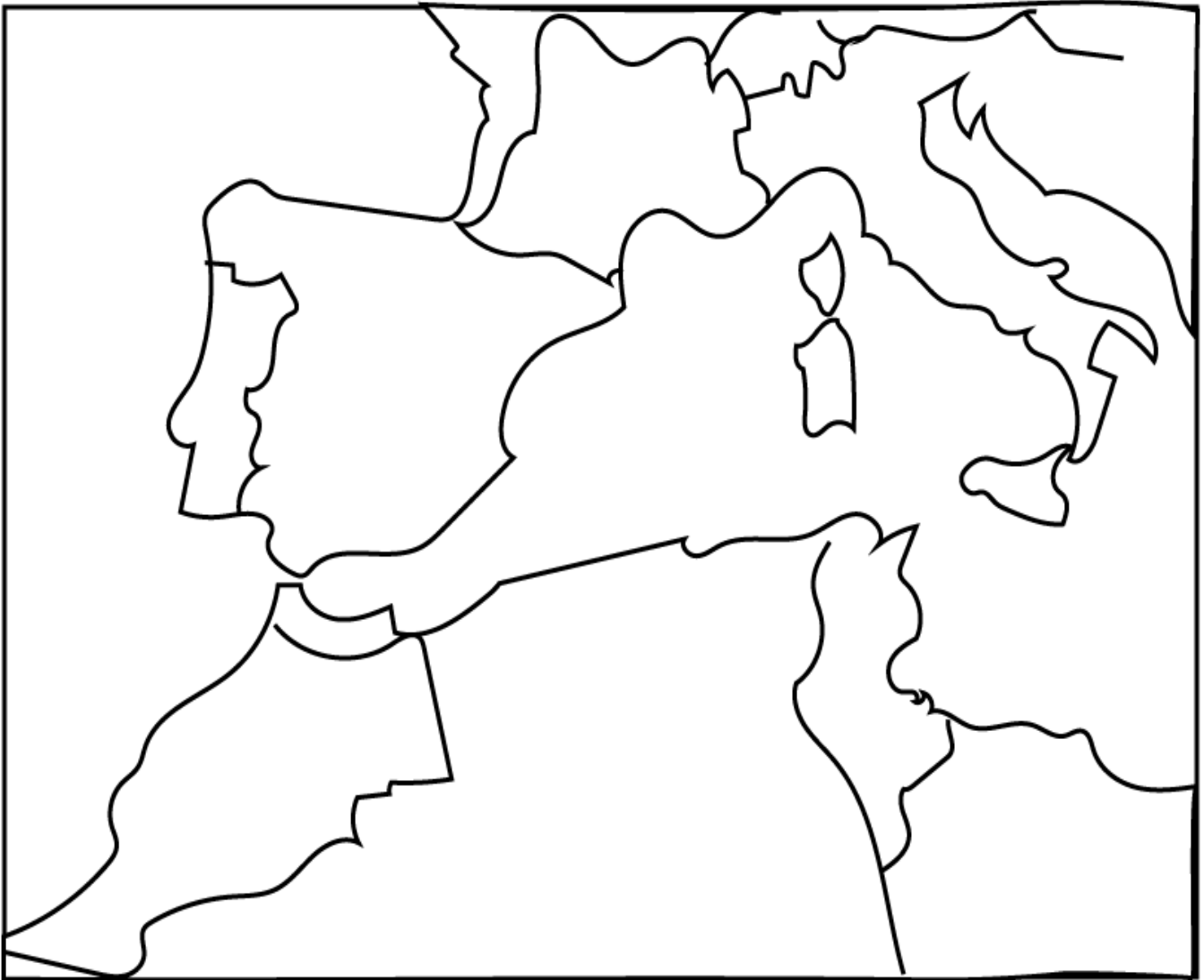

*This map shows the  
North African  
theater of the war.*





*This map shows the  
Pacific theater of the war.*

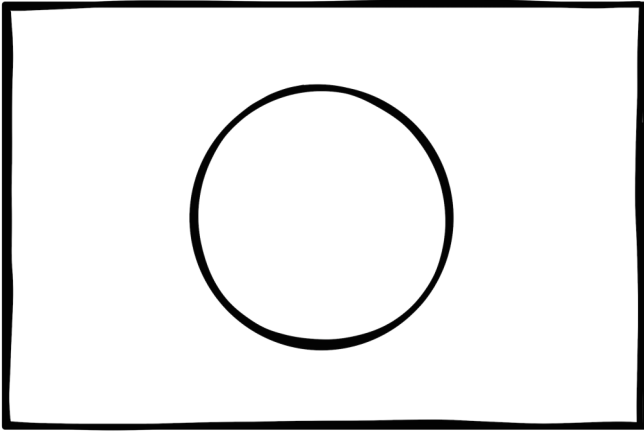

Flag of  
Japan



Japan attacked Pearl  
Harbor and brought  
the United States  
into the war.

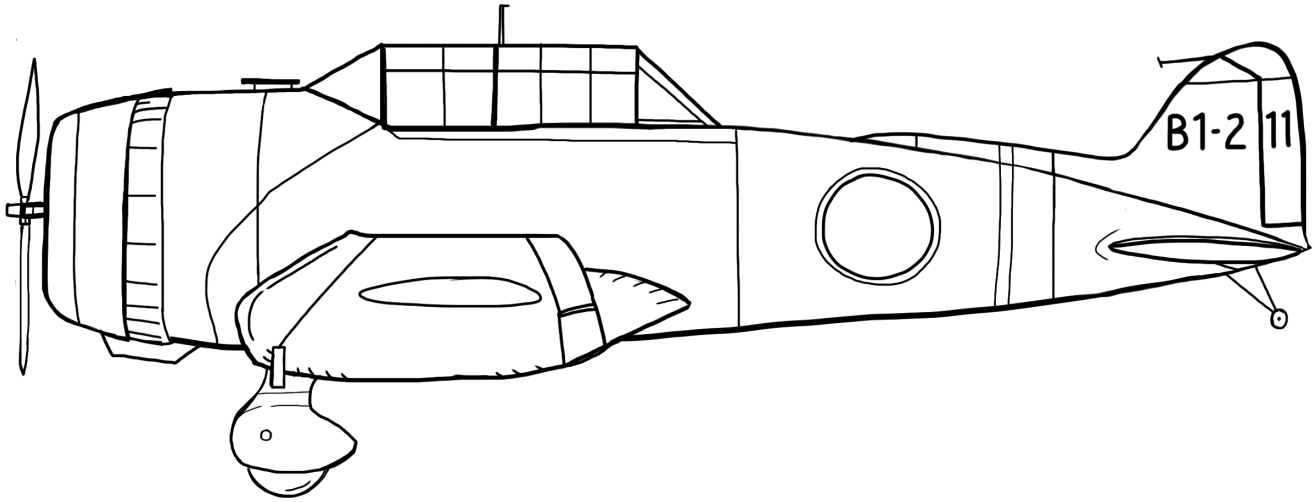

This is a Japanese  
airplane. Notice the  
same symbol on the  
plane that is on the  
Japanese flag.

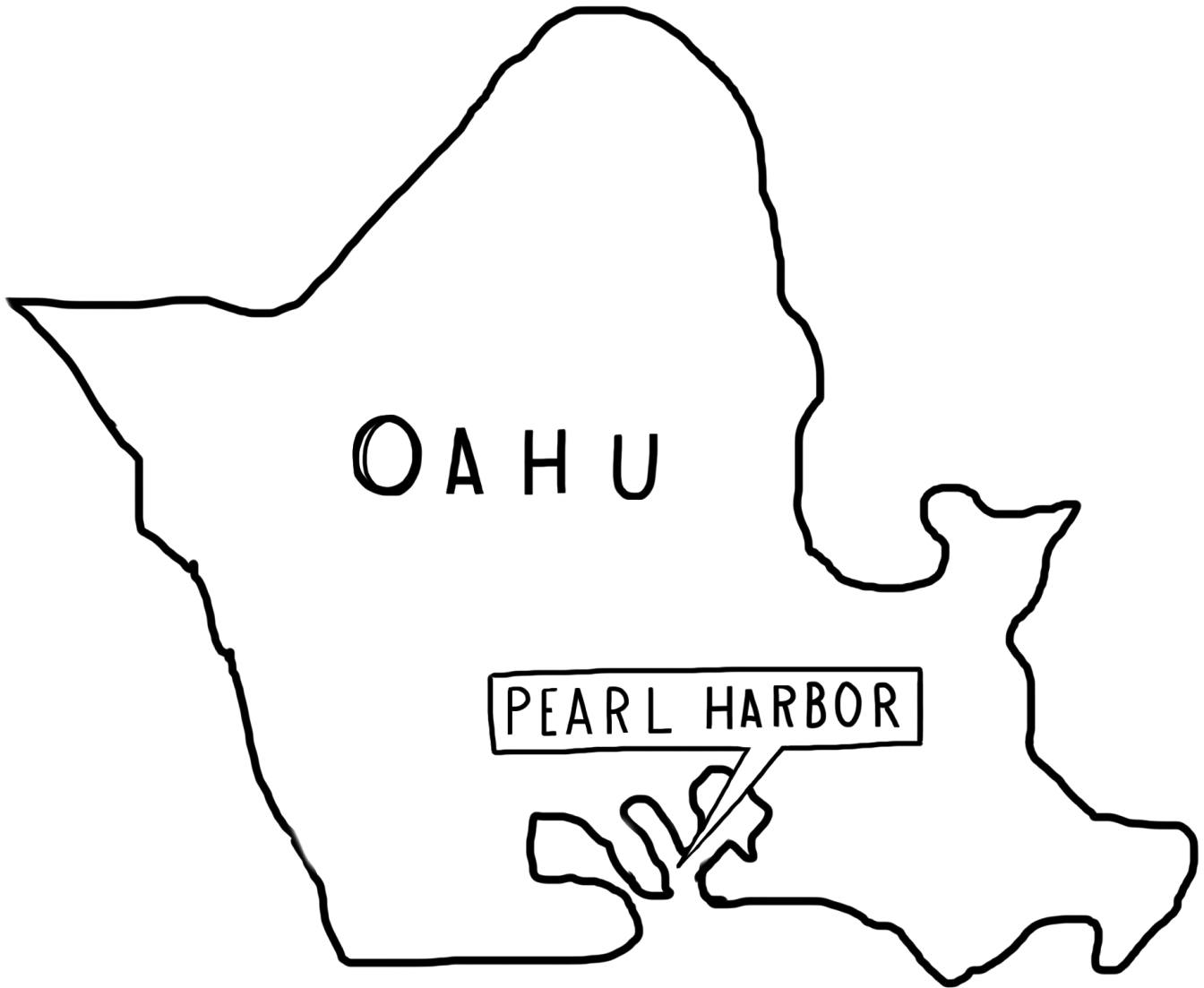

The surprise attack  
on Pearl Harbor  
killed many people.

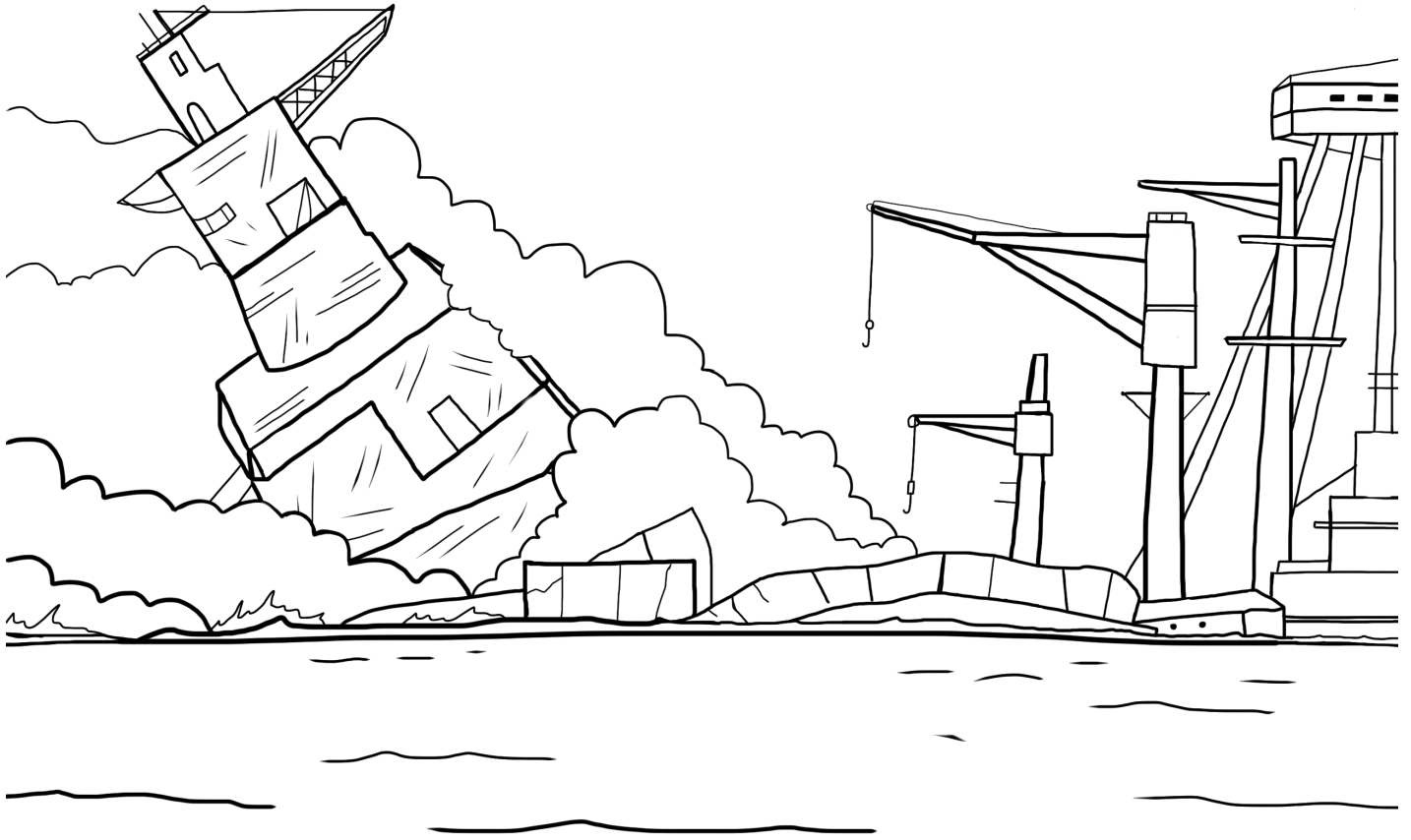

There were also many  
United States ships  
destroyed at Pearl Harbor.



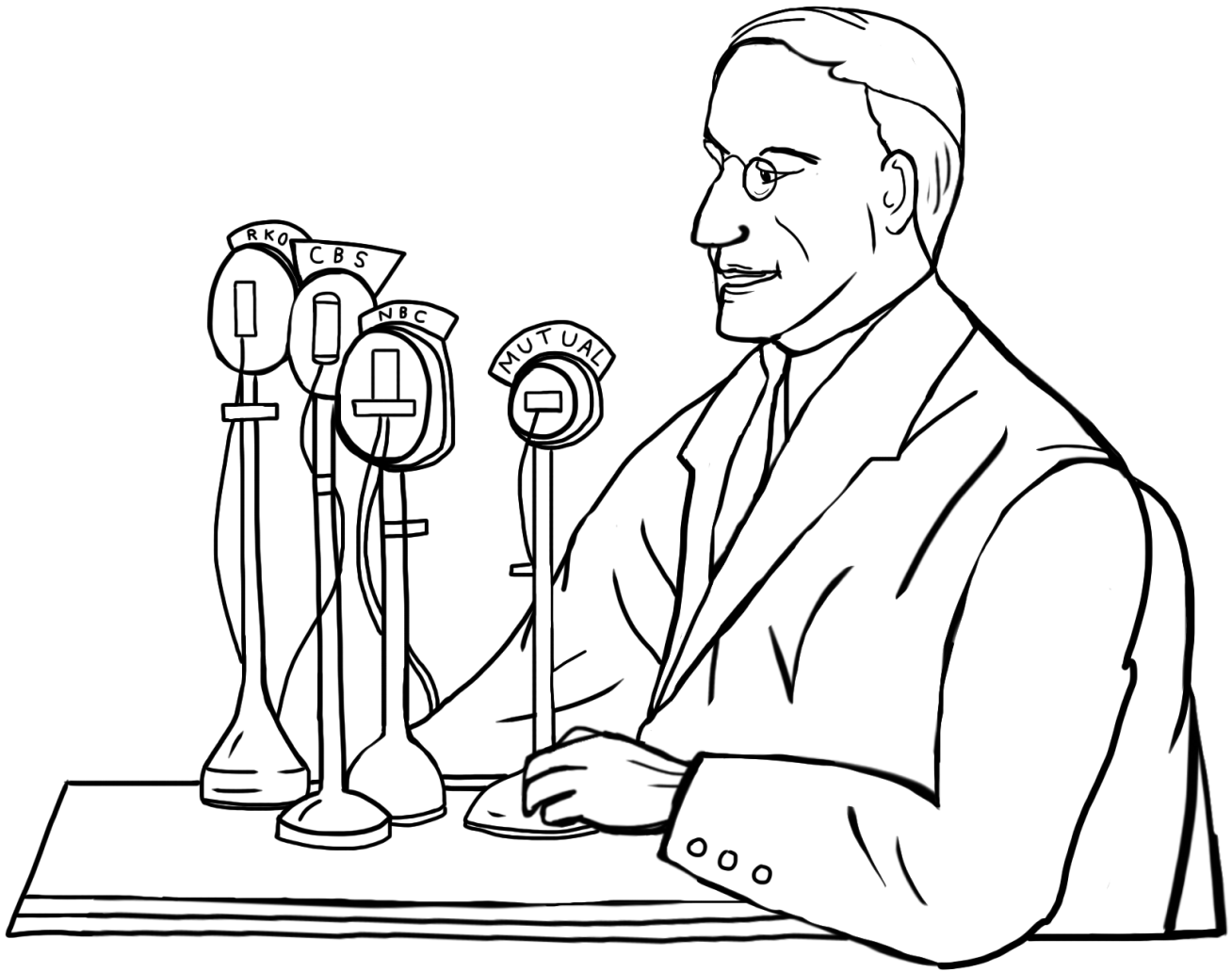

*U.S. President Franklin*

*D. Roosevelt made a*

*radio speech telling the*

*people what happened*

*at Pearl Harbor.*



*Newspapers carried the  
story of the surprise  
attack, and men  
waited to enlist in  
the armed services.*

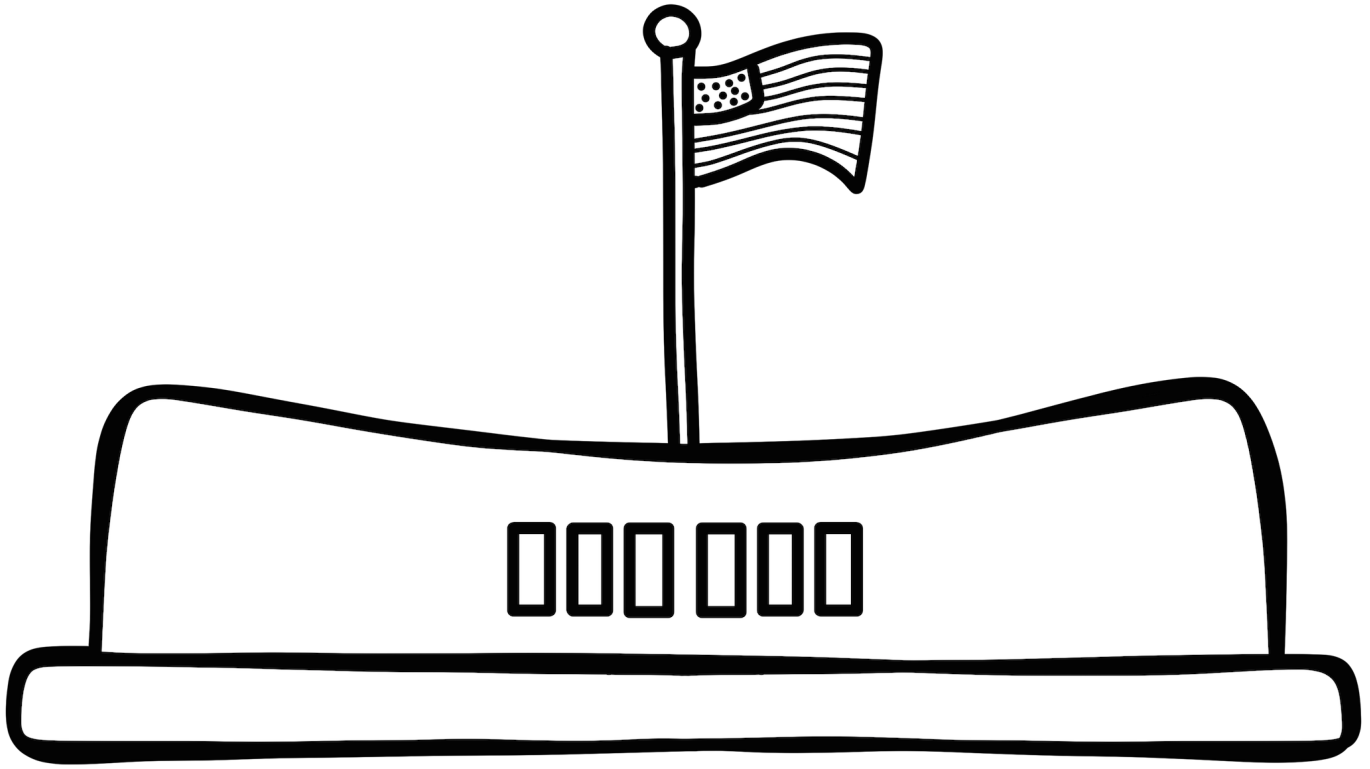

The Arizona Memorial  
at Pearl Harbor, Hawaii,  
is a remembrance of  
the surprise attack.

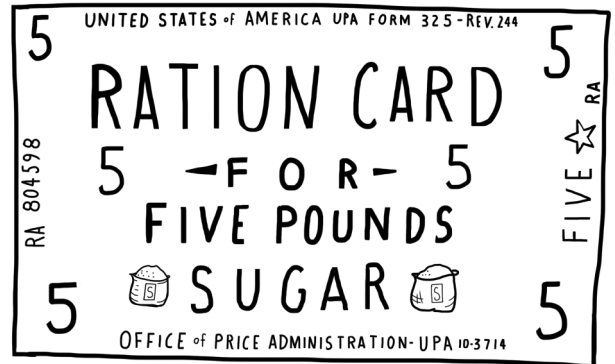
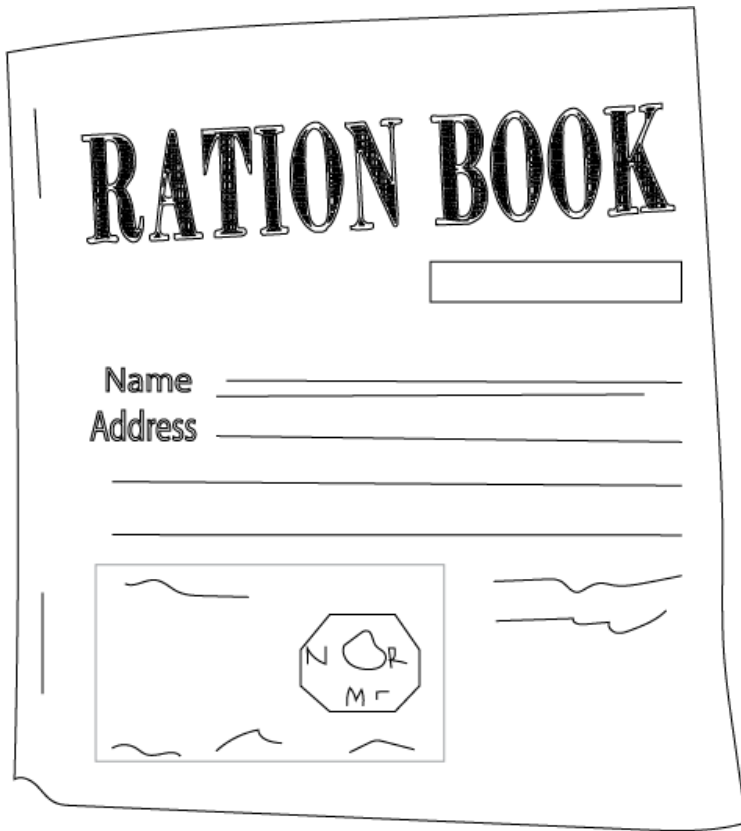

*Many countries used  
ration books and  
ration cards to be  
certain people had the  
things they needed.*

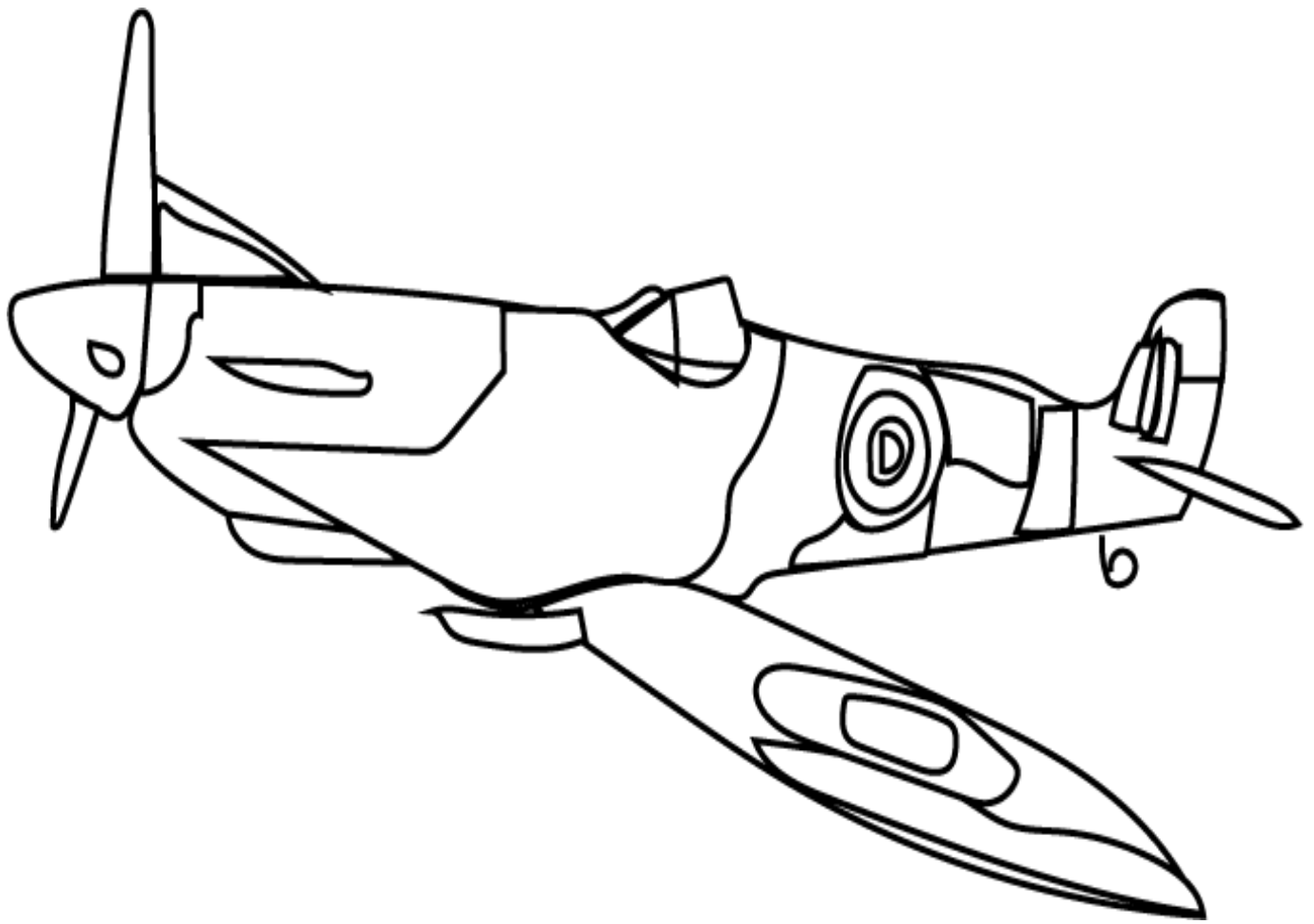

The Spitfire was  
one of the most  
important planes of  
the Royal Air Force.



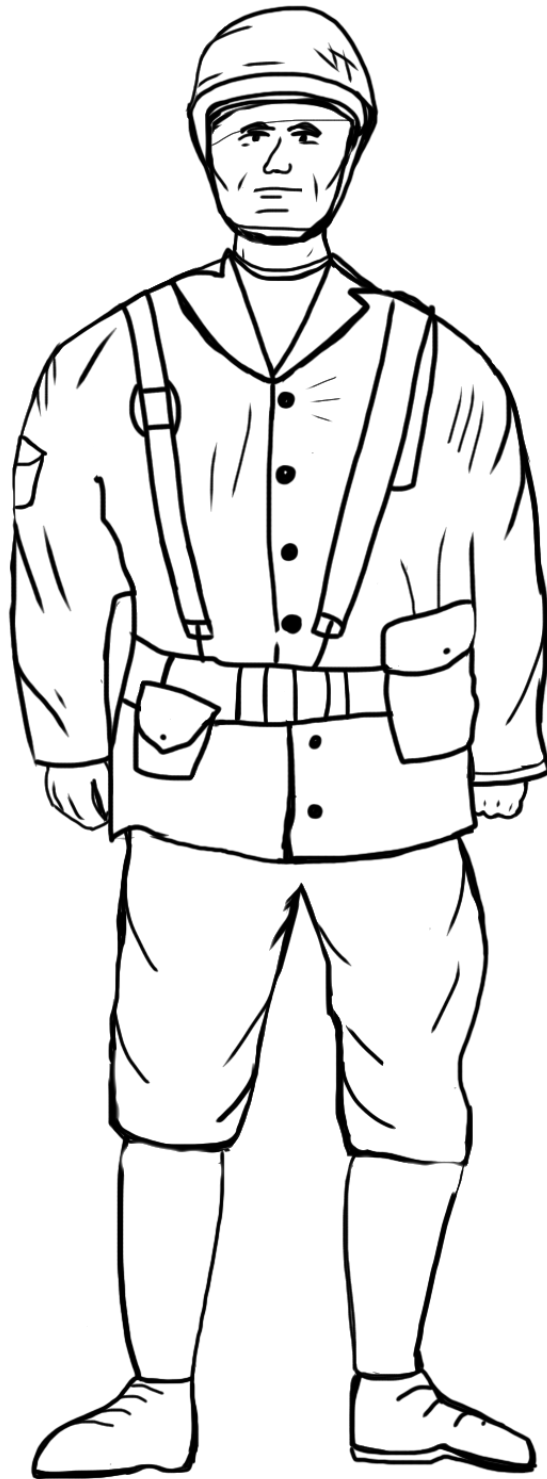

*This is an Allied soldier.*

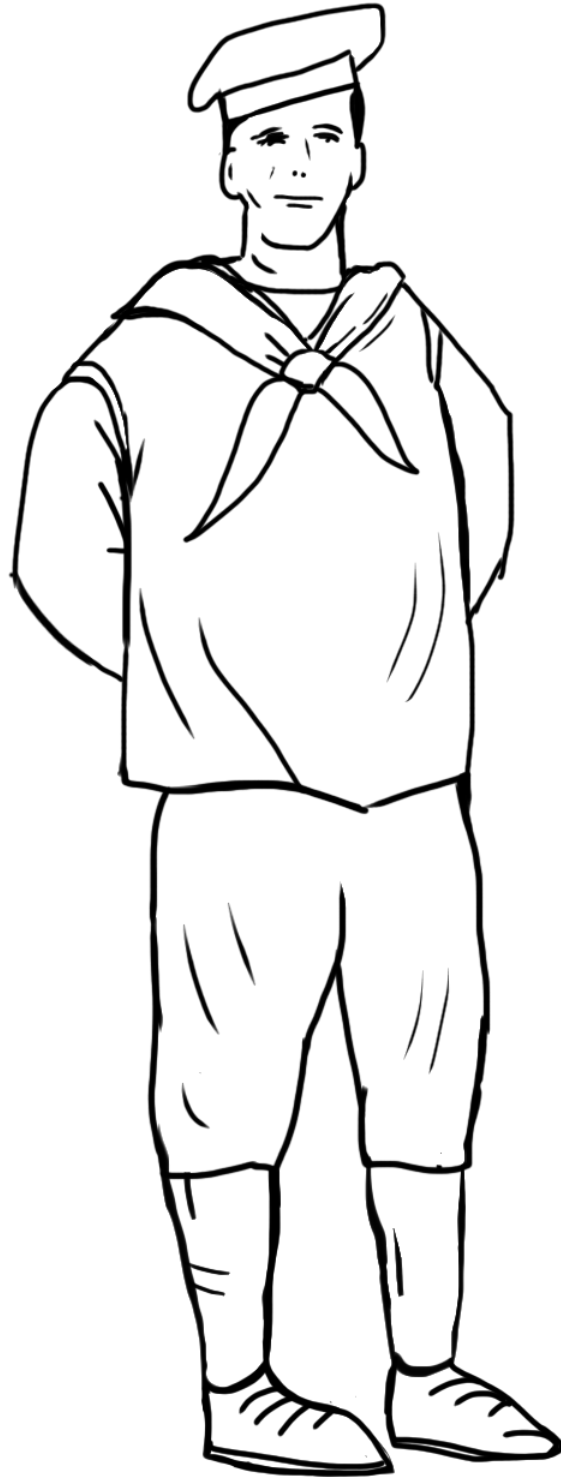

*This is an Allied sailor.*

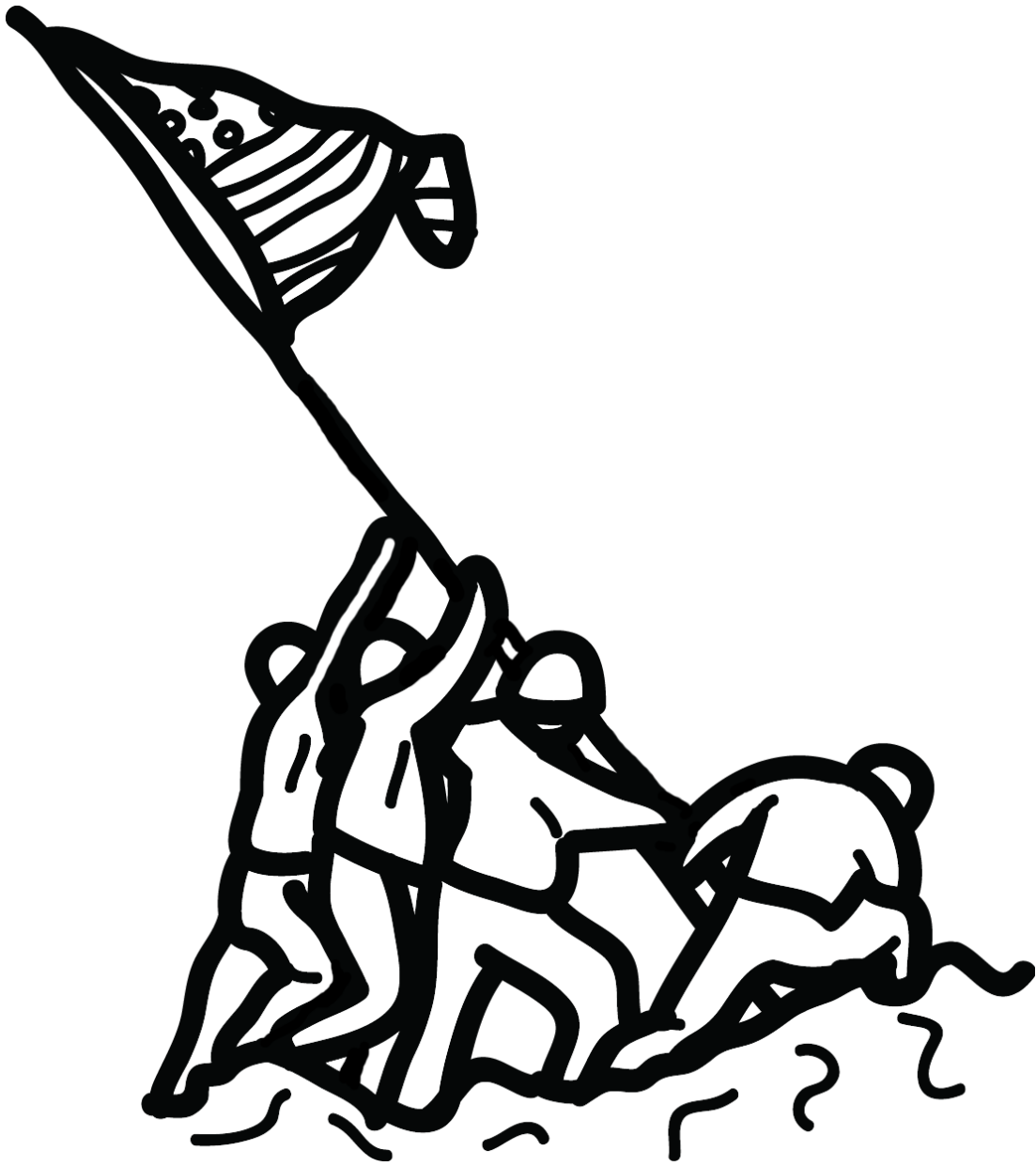

*During the Battle  
of Iwo Jima, the  
Marines raised a flag  
on Mount Suribachi.*

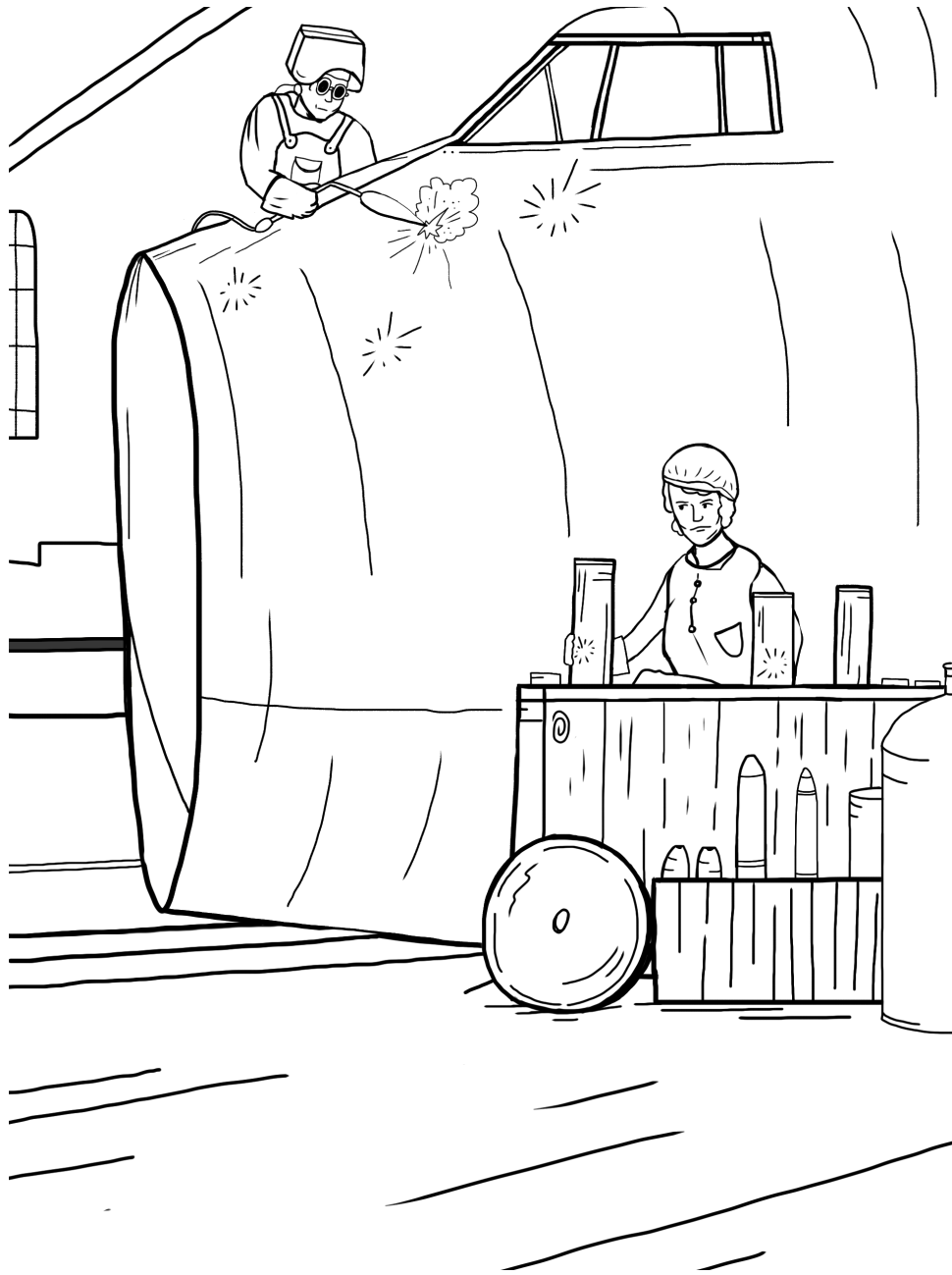

Women had to go to  
work in the factories to  
help the war effort.

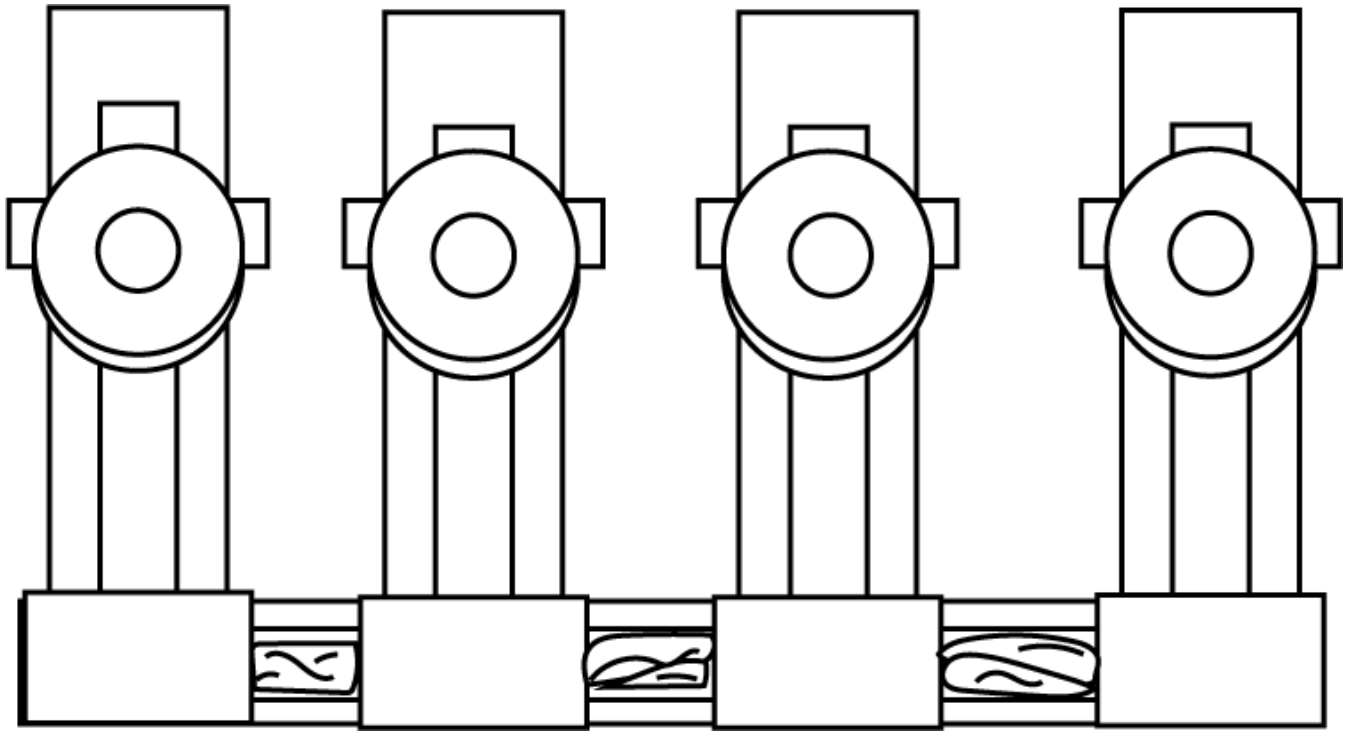

The World War II

Memorial honors all

those who served in

the US armed forces

in the war.



Thank you for downloading my product! I pray it is a blessing to you and your family. If you'd like to view more of my products and freebies, you'll find them at [WriteBonnieRose.com](http://WriteBonnieRose.com). I am adding new material almost every week, so please check back often or sign up to receive my newsletter so you don't miss a thing.

At [WriteBonnieRose.com](http://WriteBonnieRose.com), you'll find:

- Resources for Teaching Kids About the Persecuted Church and Unreached People Groups
- Copywork
- History Resources and Printables
- Holiday Resources and Printables
- Coloring Pages
- Notebooking Pages
- Timeline Worksheets and Resources
- Short Stories for Kids
- Writing Opportunities
- How to Write for Homeschoolers

I'd love to connect with you! In addition to my website, you can find me on:

[CurrClick](#)  
[Educents](#)  
[Teachers Pay Teachers](#)  
[Teacher's Notebook](#)  
[Facebook](#)  
[Pinterest](#)  
[Twitter](#)  
[Google+](#)  
[LinkedIn](#)

