



PRESCHOOL SKILLS

FUN BOOK

BONNIE ROSE HUDSON



Copyright © 2018 by Bonnie Rose Hudson



Select graphics used courtesy of [Zip-a-Dee-Doo-Dah Designs](#), [RamonaM ClipArt](#), [EduClips](#), [Artifex](#), [Alina Veja Design](#), and [Allison Fors](#)

Select graphics used courtesy of and licensed by Dancing Crayon Designs
© www.DancingCrayon.com

All Rights Reserved. This book may not be reproduced or transmitted by any means, including graphic, electronic, or mechanical, without the express written consent of the author except in the case of brief quotations embodied in critical articles and reviews and those uses expressly described in the following Terms of Use. You are welcome to link back to the author's website, <http://writebonnierose.com>, but may not link directly to the PDF file. You may not alter this work, sell or distribute it in any way, host this file on your own website, or upload it to a shared website.

Terms of Use: For use by a family, this unit can be printed and copied as many times as needed. Classroom teachers may reproduce one copy for each student in his or her class. Members of co-ops or workshops may reproduce one copy for up to fifteen children. This material cannot be resold or used in any way for commercial purposes. Please contact the publisher with any questions.

Table of Contents

How to Use This Book.....	6
Fruit	
Color by (Rhyme, Shape, Number).....	7
Tracing	12
Dauber Activities.....	15
Mazes.....	17
Counting.....	19
Sequencing	20
Patterns.....	22
Animals	
Color by (Rhyme, Number, Animal, Word).....	23
Tracing	28
Dauber Activities.....	32
Counting.....	35
Matching	37
Patterns.....	38
Shapes	
Color by (Rhyme, Shape, Animal, Word).....	39
Tracing	44
Dauber Activities.....	45
Mazes.....	49
Counting.....	52
Patterns.....	53
Spot the Shapes.....	54

Construction

Color by (Rhyme, Animal, Number, Word).....	55
Tracing	60
Mazes.....	64
Counting.....	67
What's Missing.....	68
Patterns.....	69
Follow Directions.....	70

Birthday Party

Color by (Shape, Number, Animal, Word).....	71
Tracing	75
Mazes.....	79
Counting.....	82
Sequencing	83
Patterns.....	84
Come to the Party	85

Weather

Color by (Shape, Number, Animal, Word).....	86
Tracing	90
Dauber Activities.....	93
Counting.....	96
Sequencing	98
Patterns.....	99
Let's Be Weather Forecasters	100

Sports

Color by (Shape, Number, Animal, Word).....	101
---	-----

Tracing	105
Mazes	109
Counting.....	111
Matching	112
Patterns.....	114
On the Same Team.....	115



How to Use This Book

These 105 preschool skills worksheets are arranged into 7 themes: fruit, animals, shapes, construction, birthday party, weather, and sports. You can use just the worksheets needed to study a specific theme, or work through all the themes to cover the full range of skills included. These worksheets explore rhyming words, number recognition, number words, shapes, seasons, color words, animal recognition, and fine motor skills. Activities include a range of color by activities, such as color by rhyme, color by shape, color by number, color by animal, and color by number word or color word, as well as mazes, tracing, patterns, counting, matching, dauber activities, and sequencing.

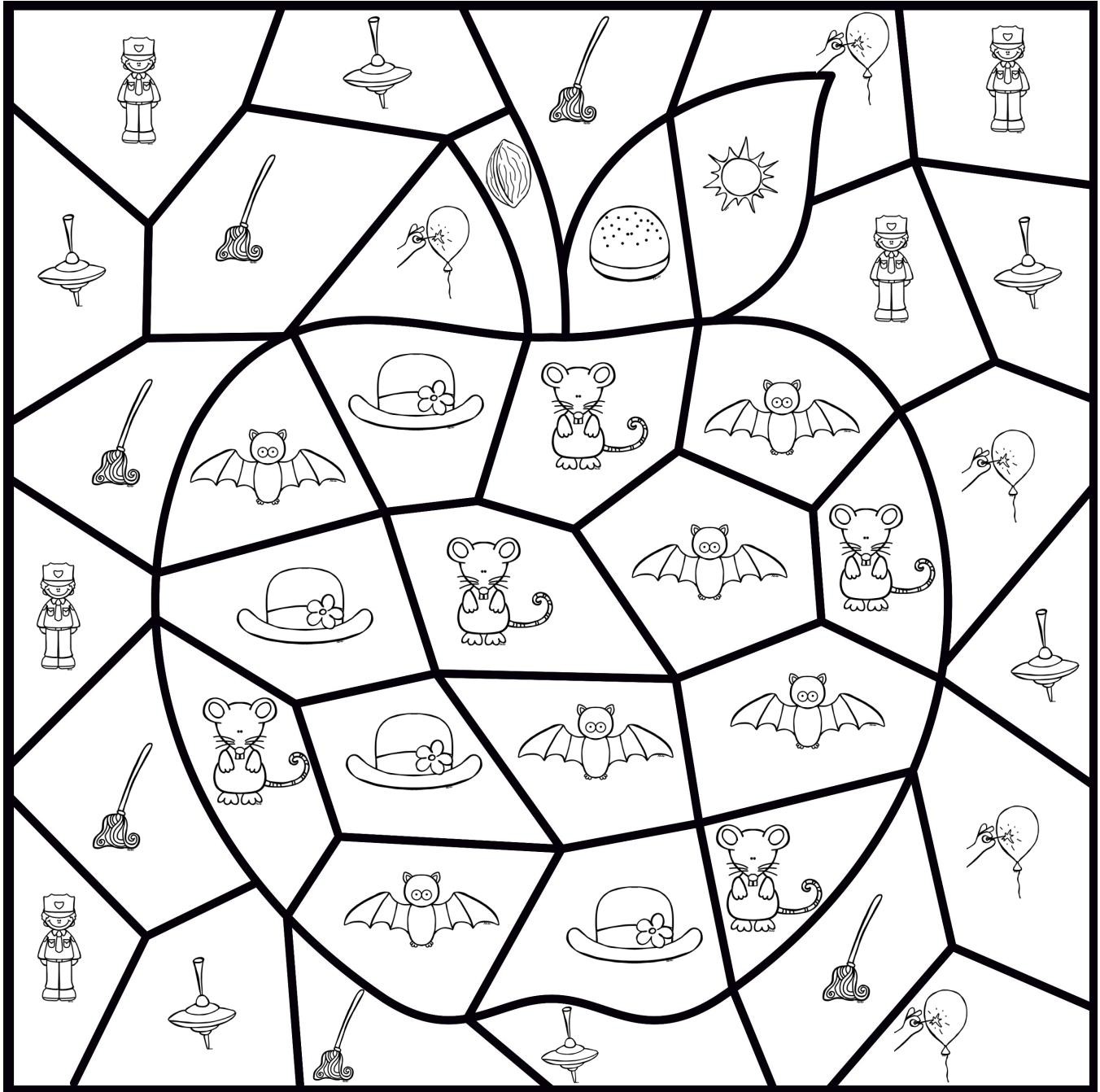
Color by Rhyme



Follow the directions to color the picture.

If the word rhymes with cat  color the space red .

If the word rhymes with run  color the space green .

If the word rhymes with cut  color the space brown .

If the word rhymes with hop  color the space orange .

Color by Rhyme

Key



cat



cut



bat



nut

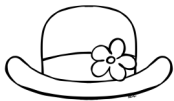

hat



hop



rat



cop



run



mop

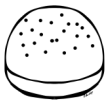

bun



pop



sun



top

Color by Shape

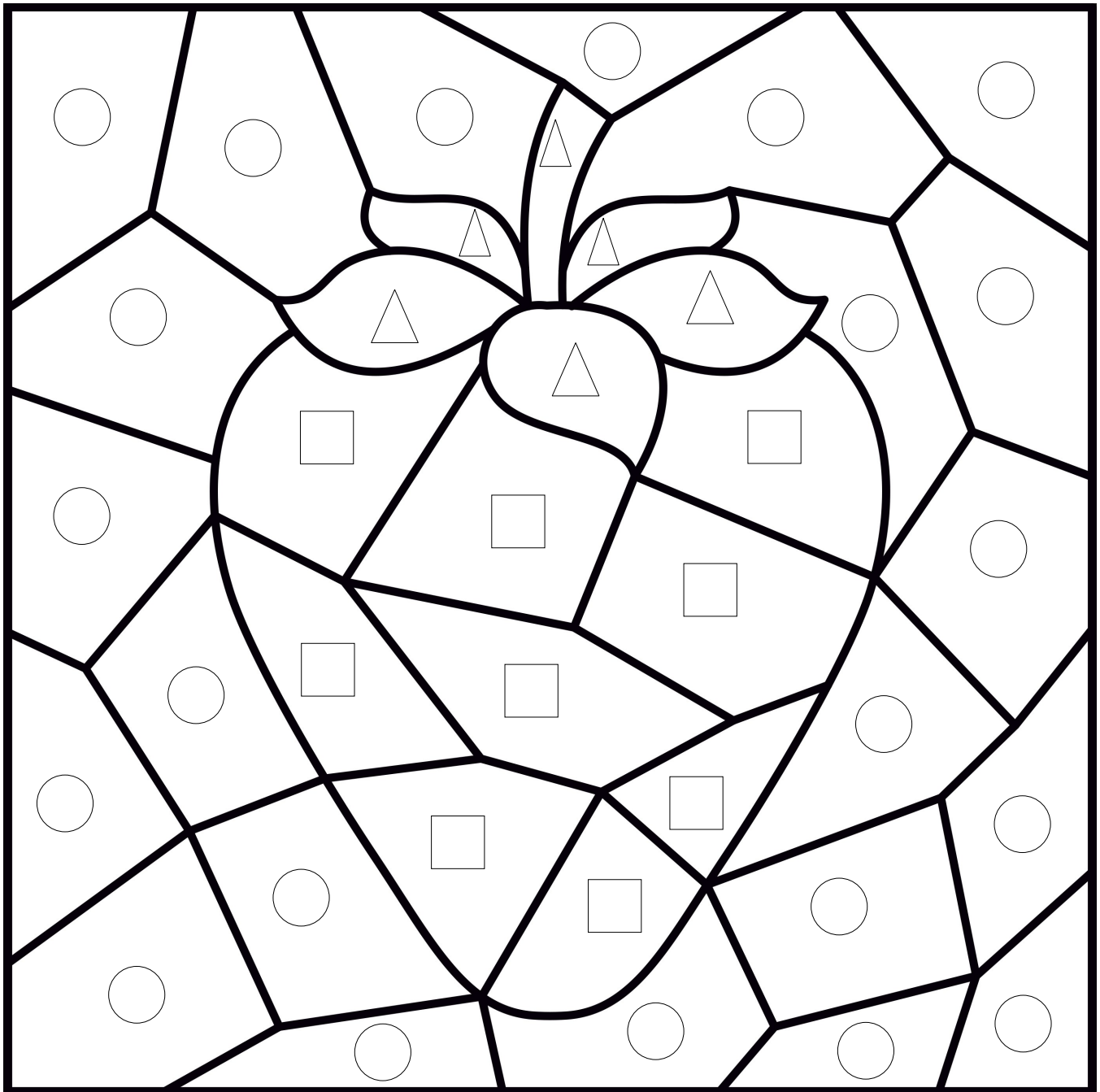

Follow the directions to color the picture.

Color the spaces with a square  red .

Color the spaces with a triangle  green .

Color the spaces with a circle  purple .

Color by Number

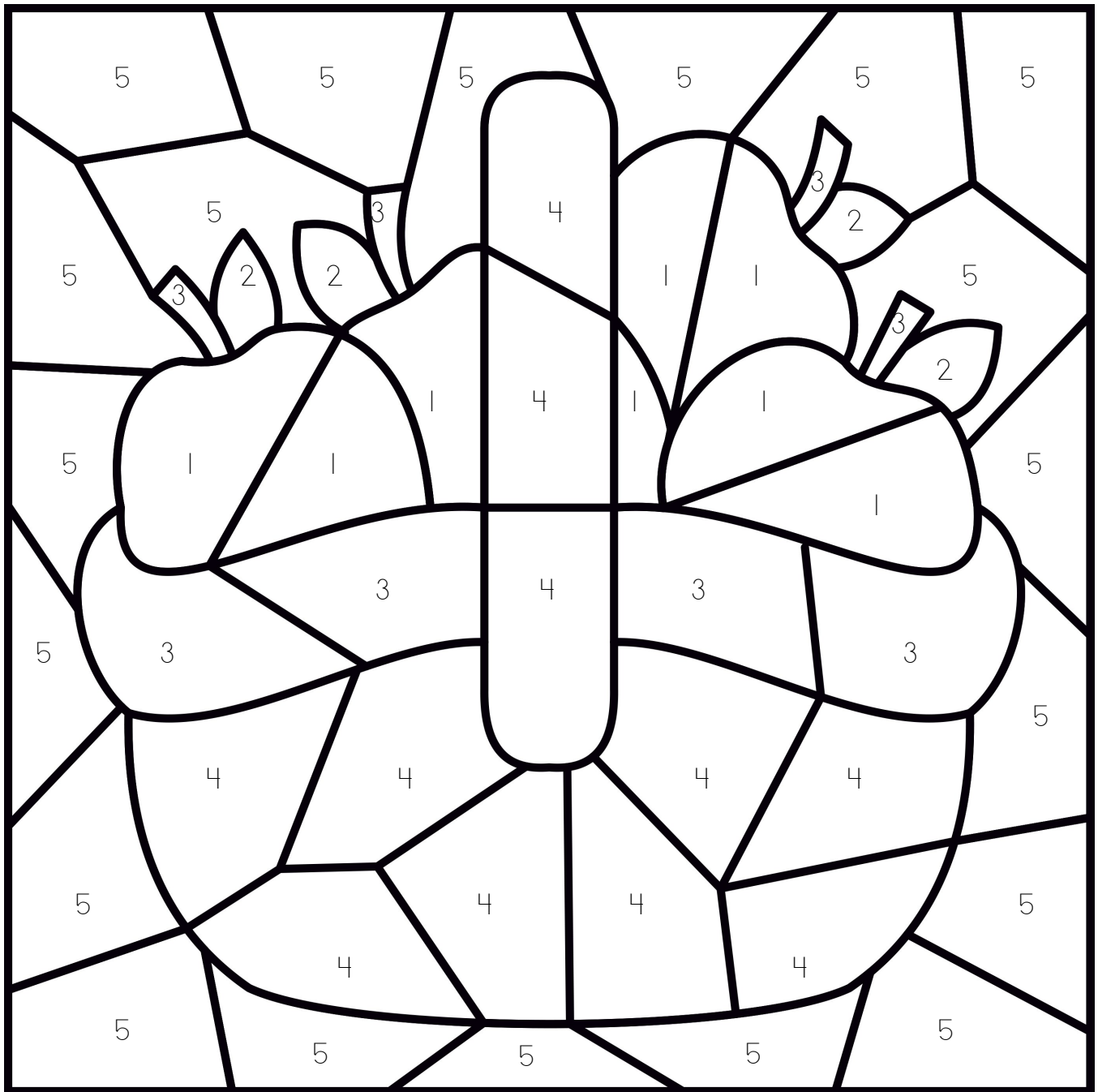

Follow the directions to color the picture.

Color the spaces with a 1 red ●.

Color the spaces with a 2 green ●.

Color the spaces with a 3 brown ●.

Color the spaces with a 4 orange ●.

Color the spaces with a 5 yellow ●.

Color by Number

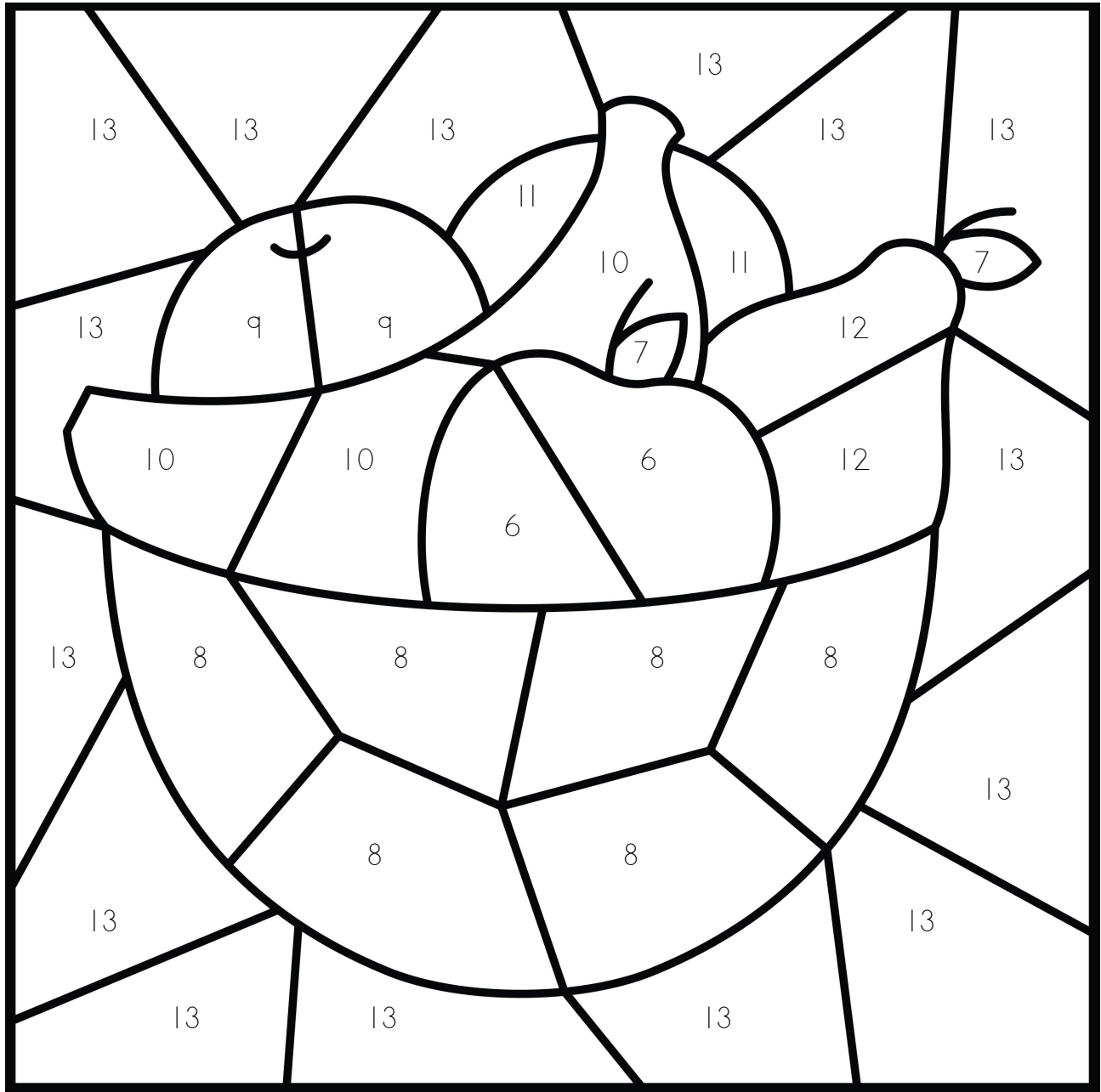

Follow the directions to color the picture.

- Color the spaces with a 6 red ●.
- Color the spaces with a 7 dark green ●.
- Color the spaces with an 8 brown ●.
- Color the spaces with a 9 orange ●.
- Color the spaces with a 10 yellow ●.
- Color the spaces with an 11 purple ●.
- Color the spaces with a 12 light green ●.
- Color the spaces with a 13 blue ●.

Apple Tracing

Trace the lines to draw the apple. You can color the picture if you like.

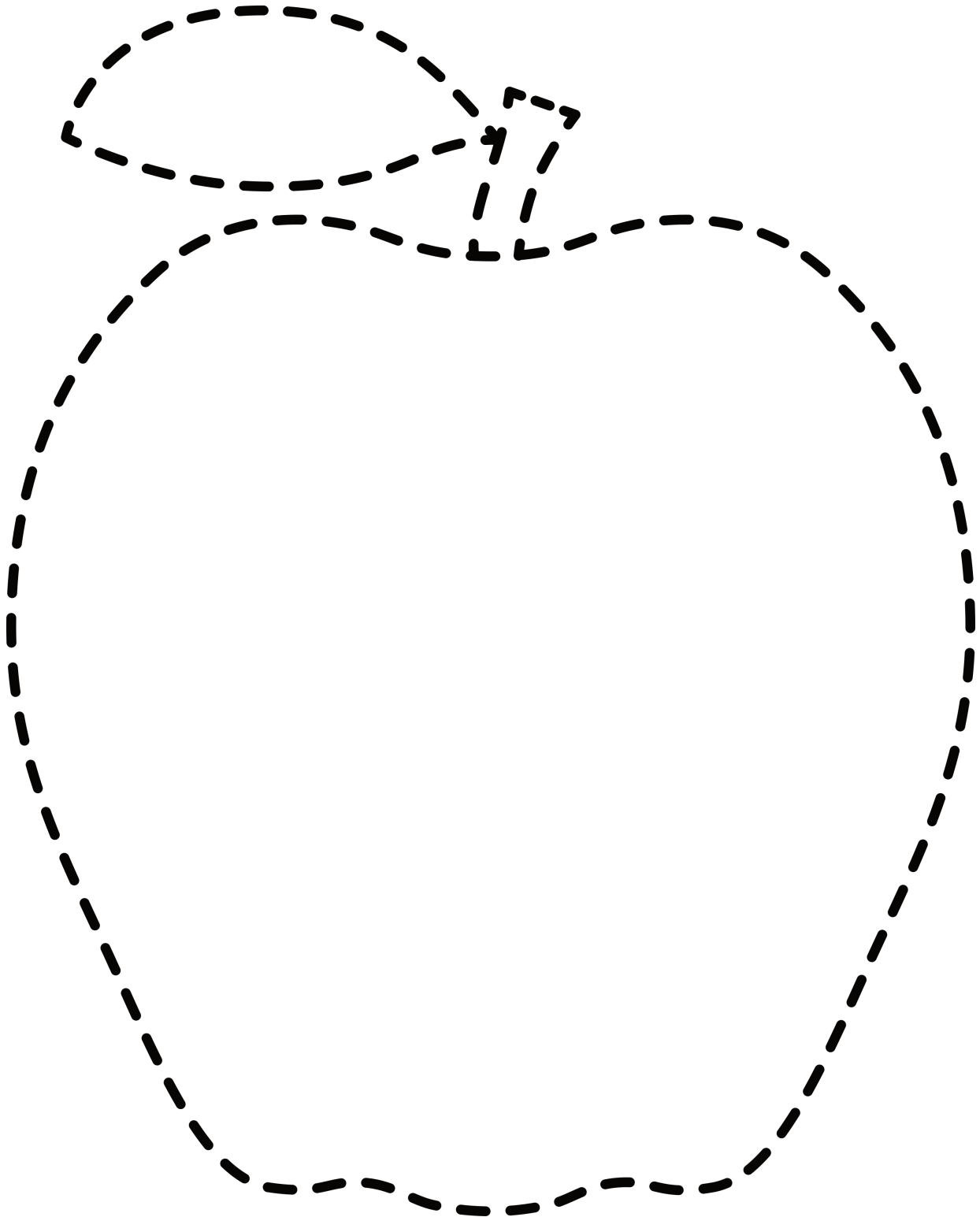

Fruit Tracing

Trace the lines to draw the fruit. You can color the pictures if you like.

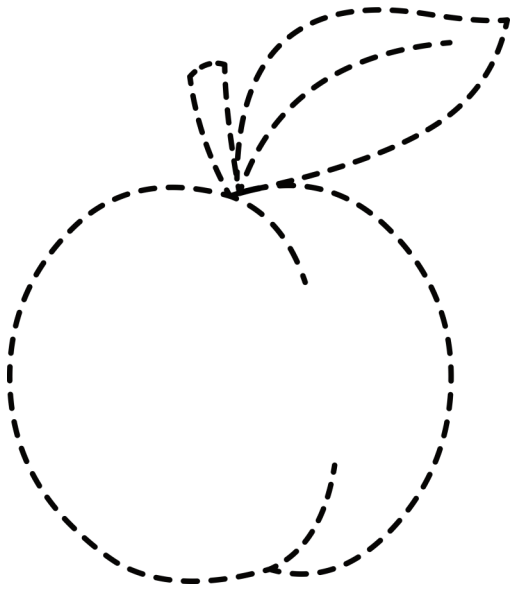

Plum

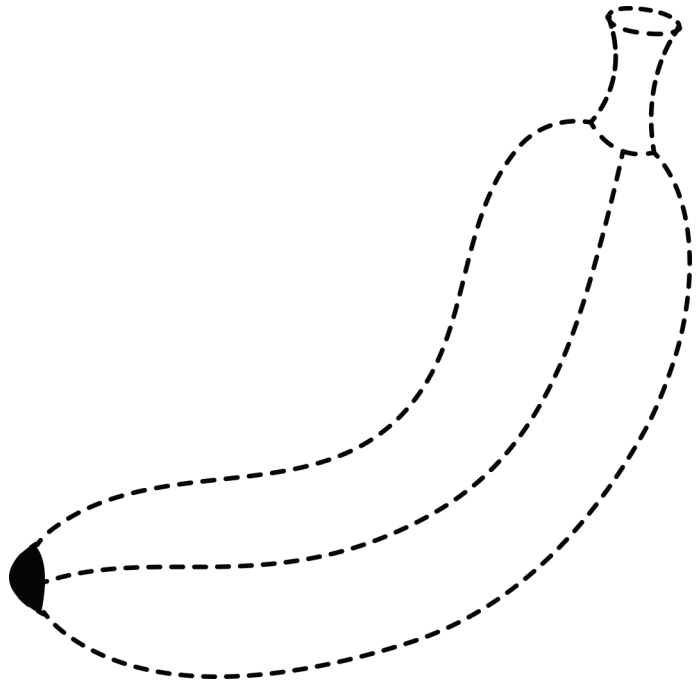

Banana

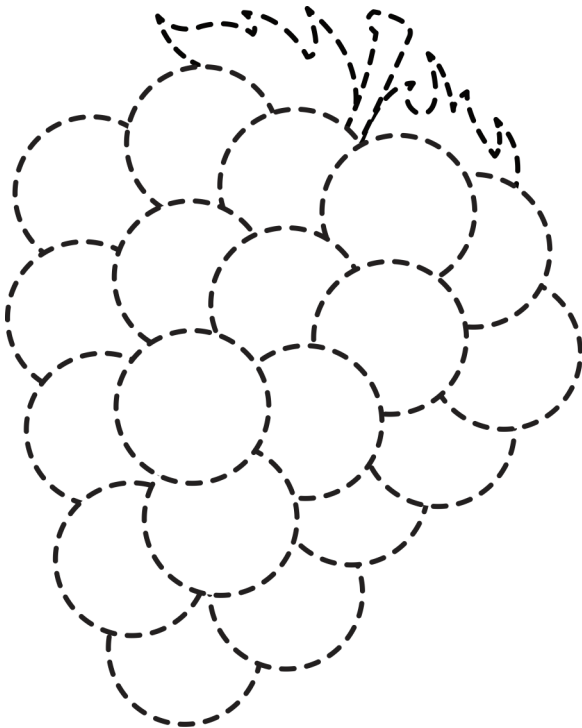

Grapes

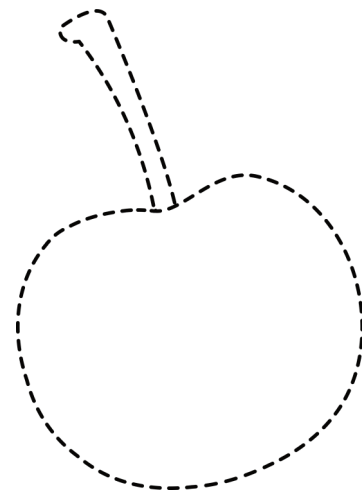

Cherry

Strawberry Tracing

Trace the lines to draw the strawberry. You can color the picture if you like.

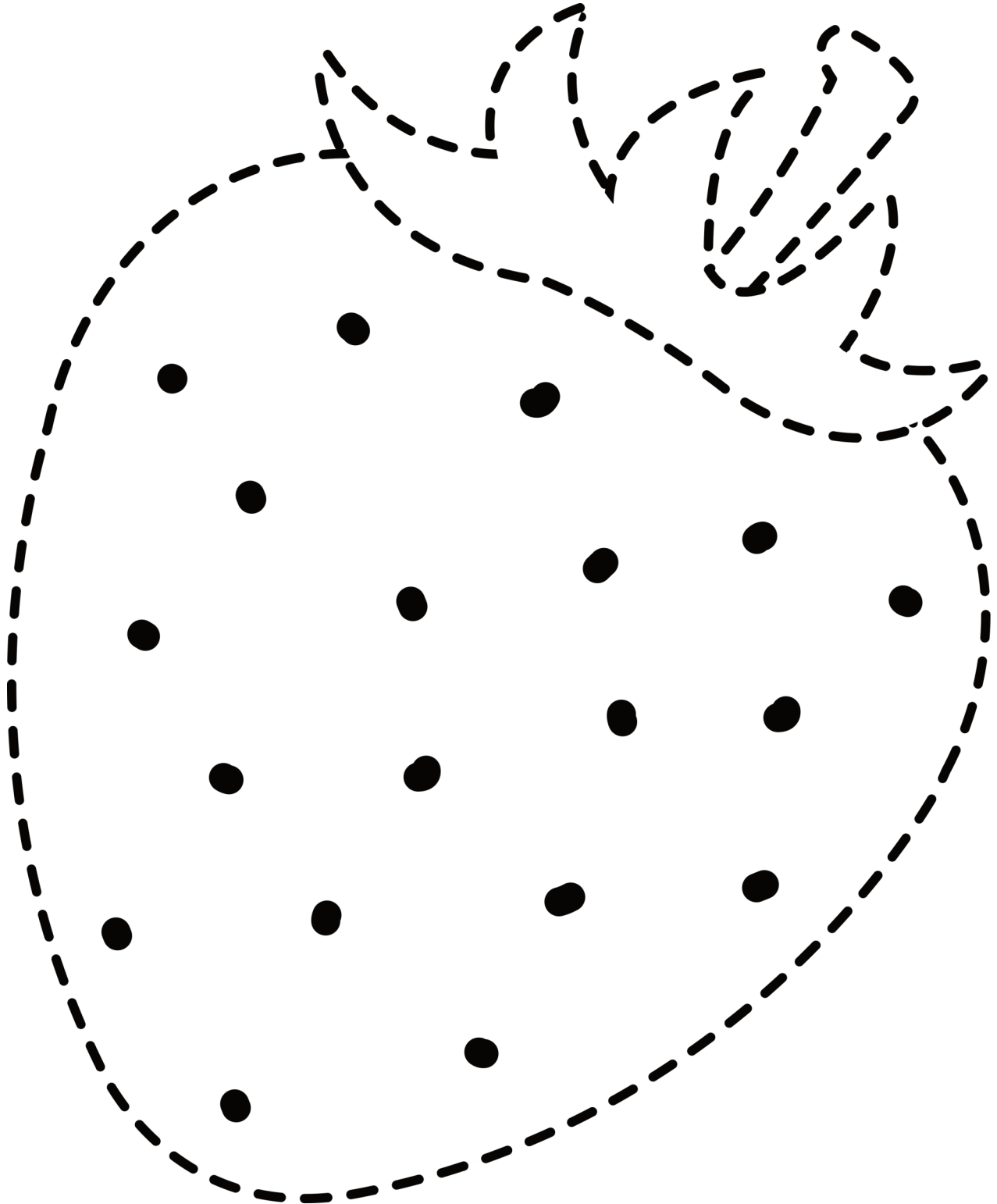

Dot the Apple

Use a dauber to make the picture of the apple. You can color the rest of the picture if you like.

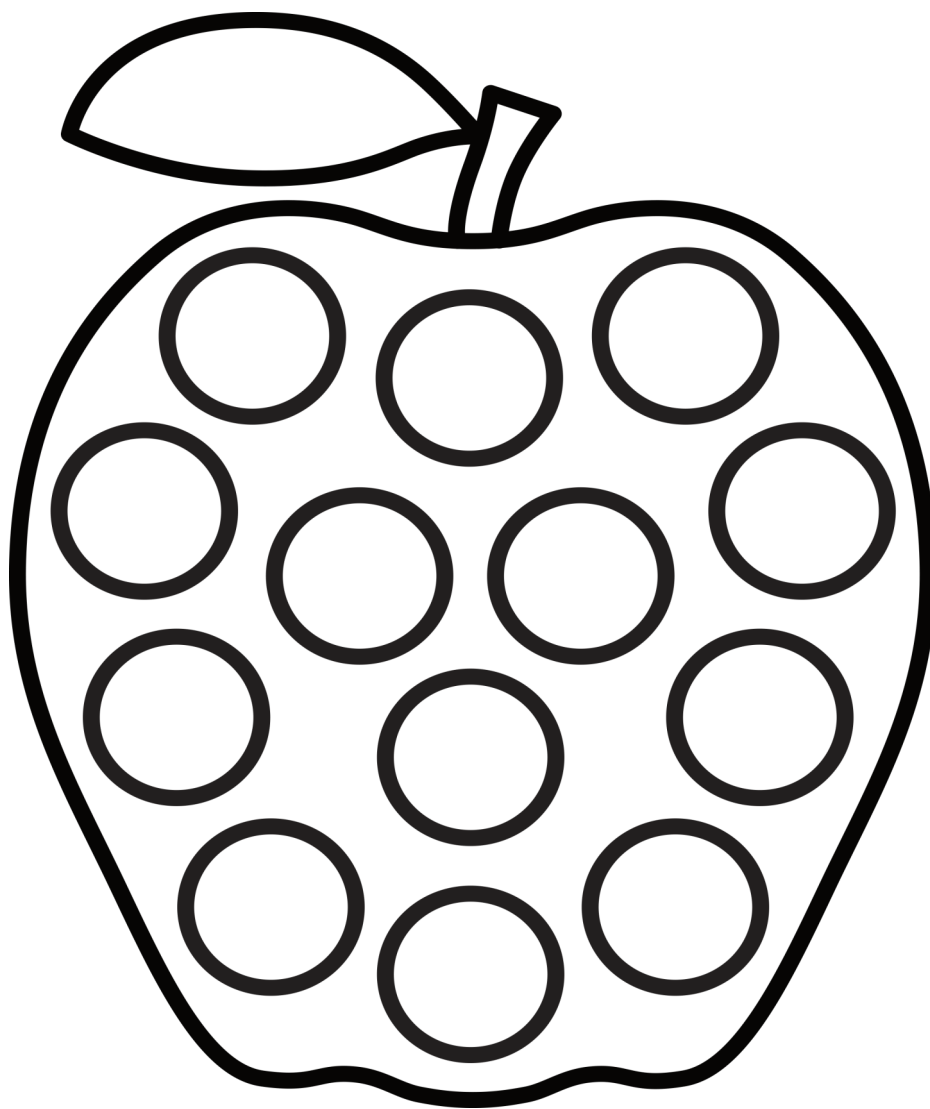

Dot the Strawberry

Use a dauber to make the picture of the strawberry. You can color the rest of the picture if you like.

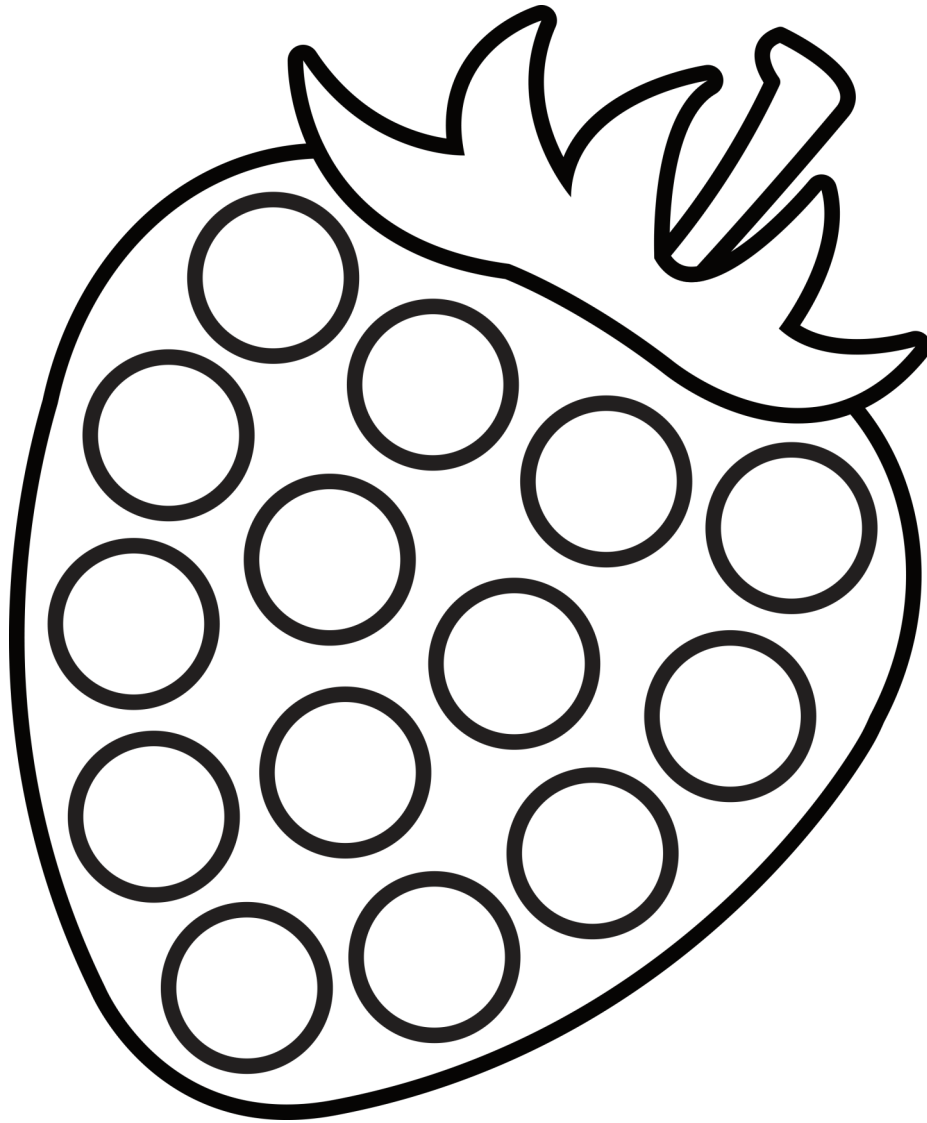

Find Your Way Pear

When the letters to spell “pear” went through the maze, the “e” got lost. Help the “e” find its way through the maze and then write the “e” in its space in the word.

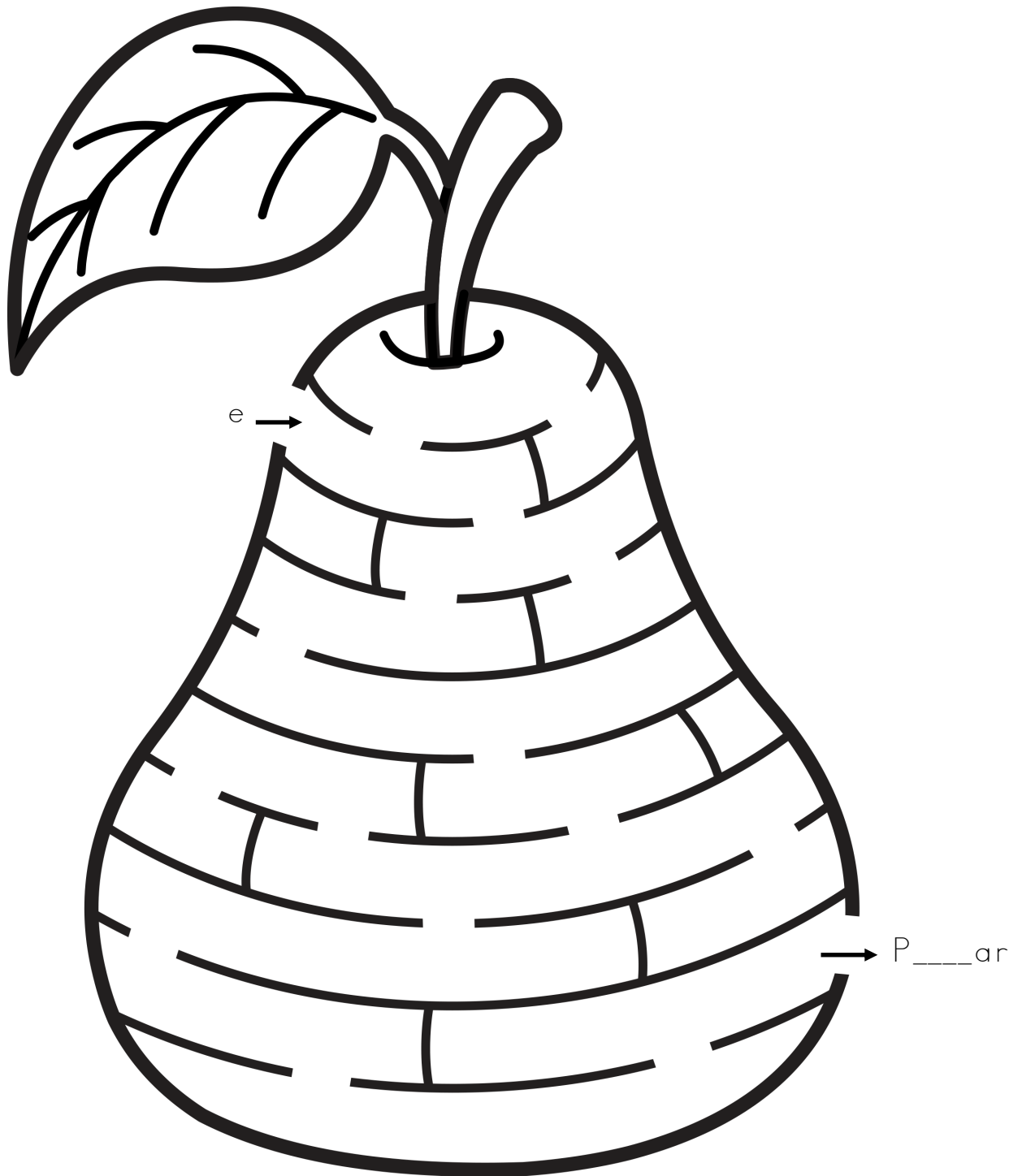

Find Your Way Pineapple

When the letters to spell “pineapple” went through the maze, the “a” got lost. Help the “a” find its way through the maze and then write the “a” in its space in the word.

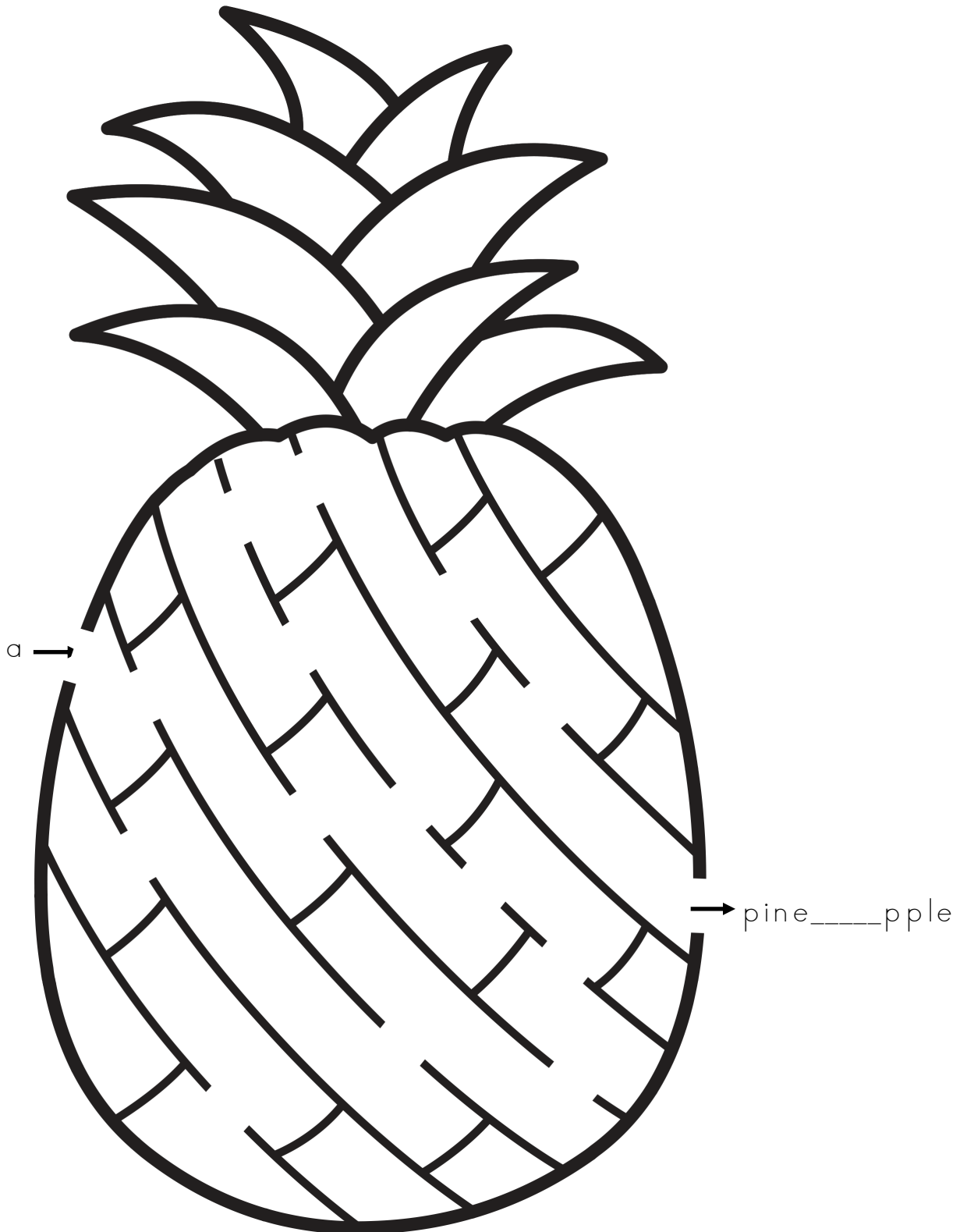

Count the Apples

Count the apples on each tree. Under the tree are three numbers. Circle the number that shows how many apples are on the tree.

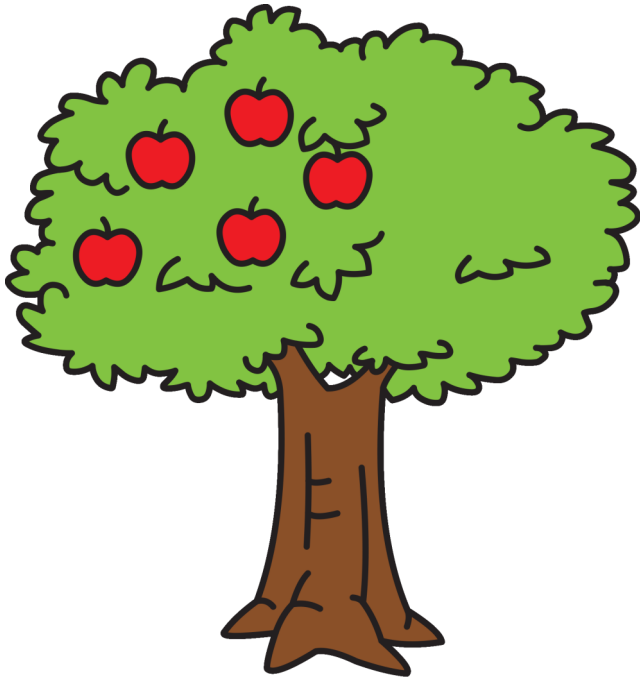

7 6 5

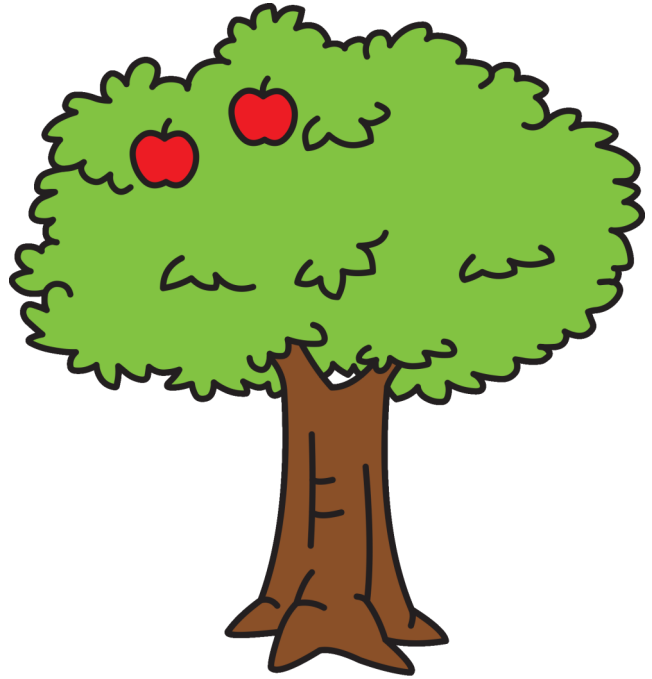

1 2 3

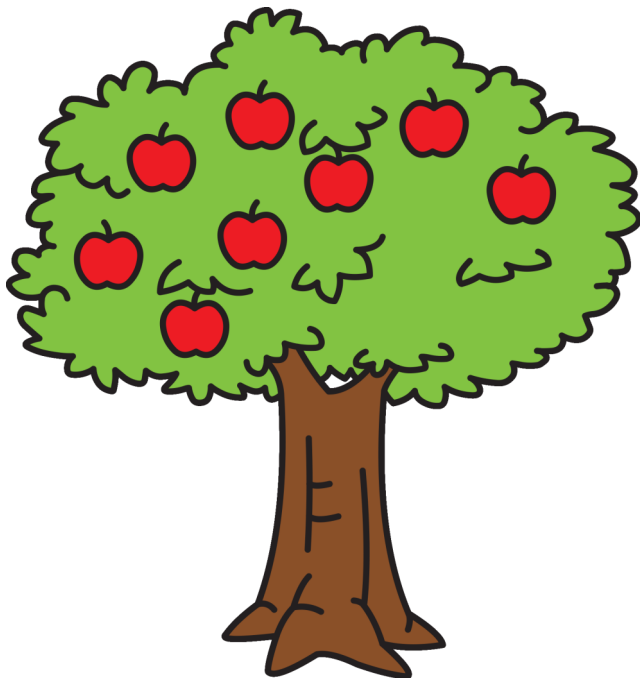

8 9 10

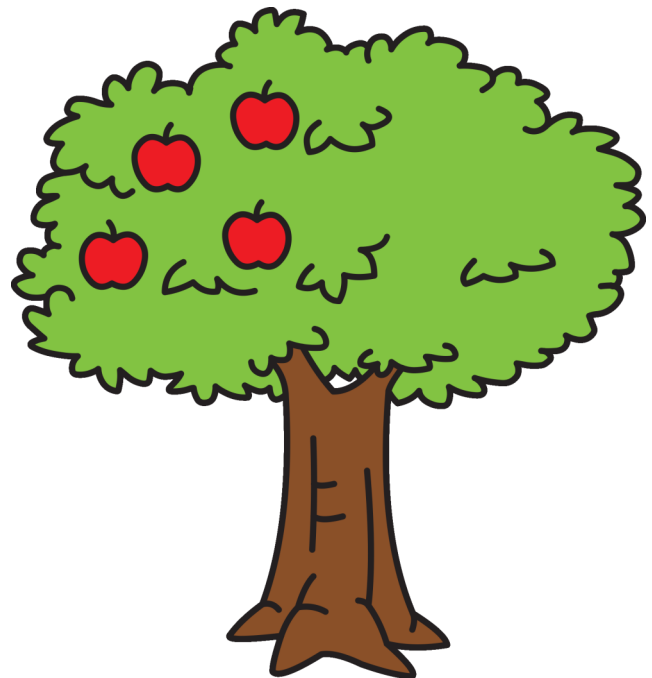

3 4 5

Eating Watermelon

Have you ever eaten a piece of watermelon? The pictures show how a piece of watermelon looks from the time you get it to eat until you are all finished. Put a number in the box below each piece of watermelon to show how it looks when you first get it (1) to how it looks when you are finished eating it (4).

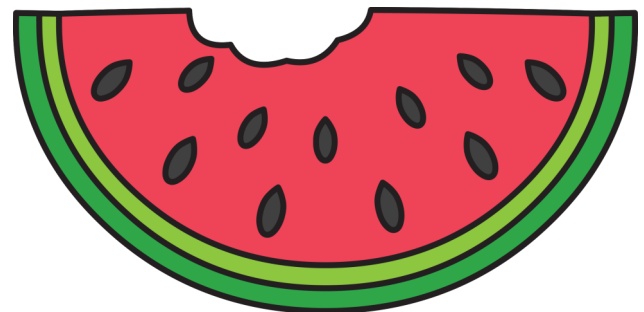
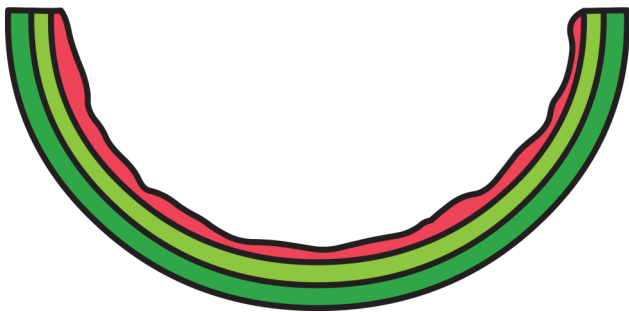
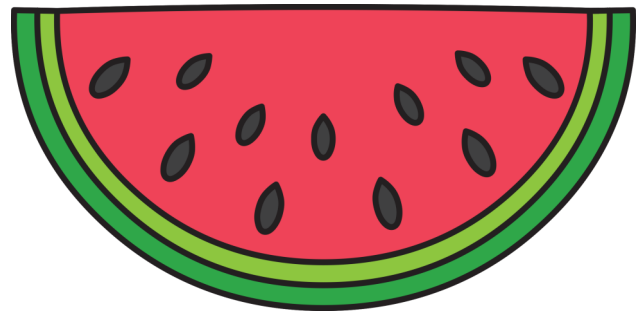
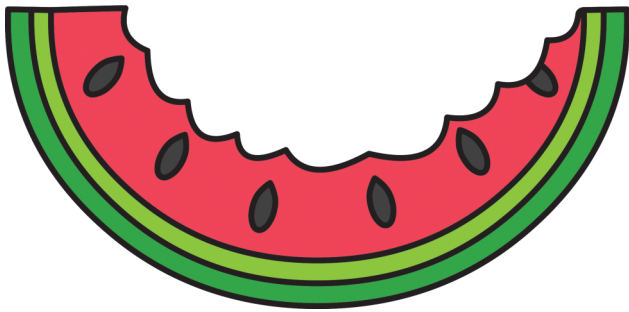

Picking Apples

The little girl in the picture went out to pick apples from the tree. When she got to the tree, there were lots of apples on the tree and none in her basket. When she was finished, there were no apples on the tree and lots of apples in her basket. Put a number in the box below each picture to show how it looked when she started picking apples (1) to how it looked when she was finished picking apples (4).



What Comes Next?

Look at each row of fruit below. At the end, there is a space where the next fruit is missing. Draw a circle around the fruit that goes next in the row.

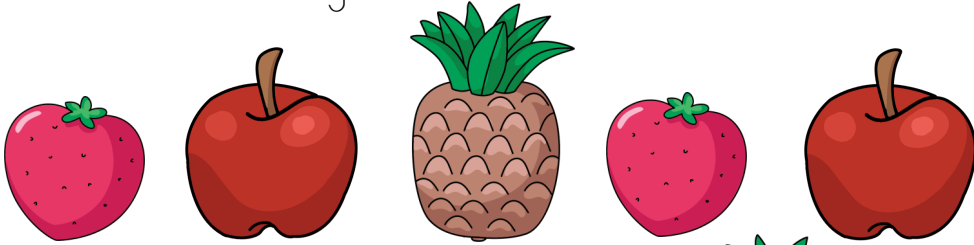

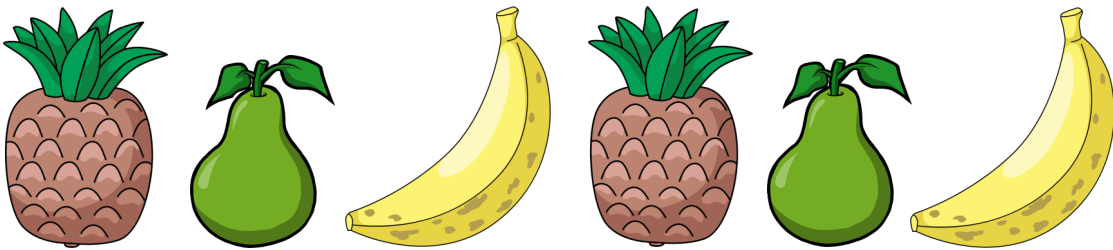
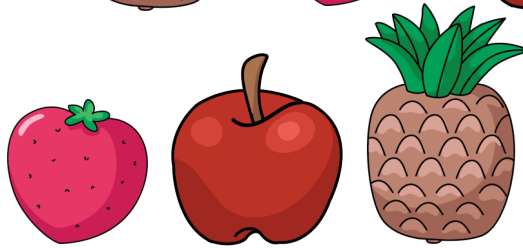

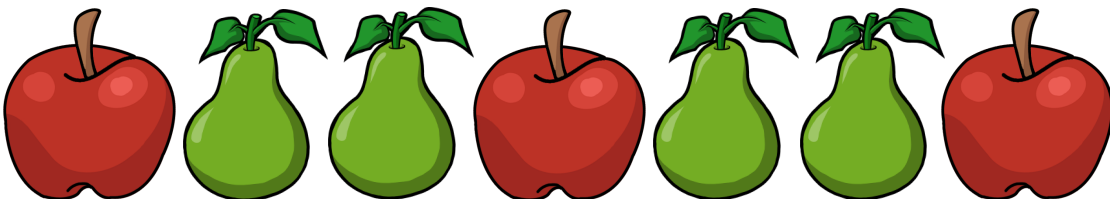
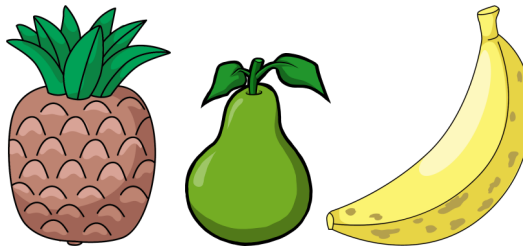



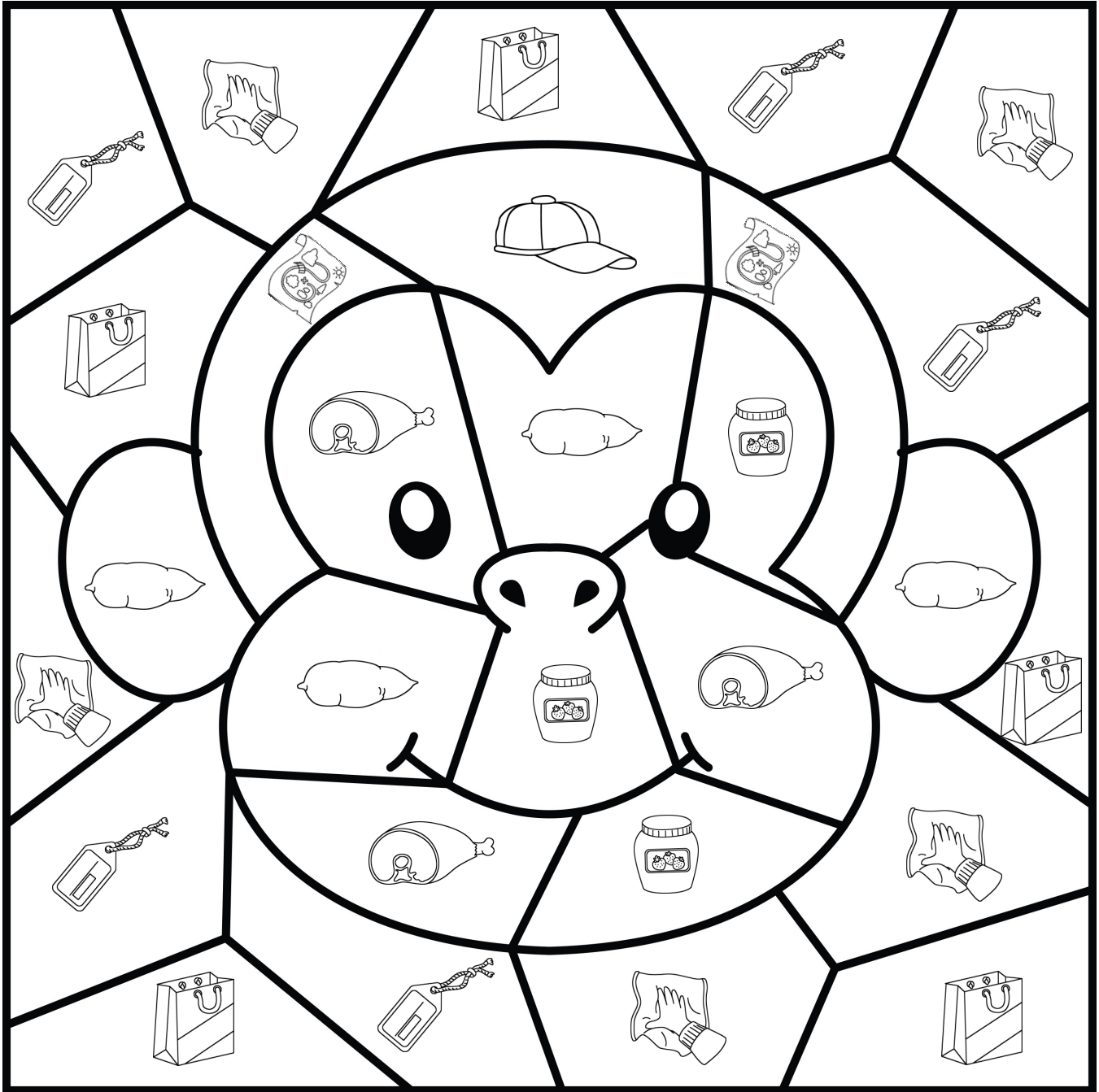

Color by Rhyme

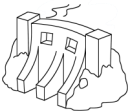

Follow the directions to color the picture.

If the word rhymes with dam  color the space light brown .

If the word rhymes with wag  color the space yellow .

If the word rhymes with nap  color the space dark brown .

Color and Rhyme Key

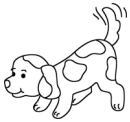

wag



dam

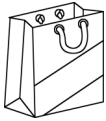

bag



ham



rag



jam



tag



yam



nap



map

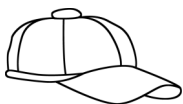

cap

Color by Number

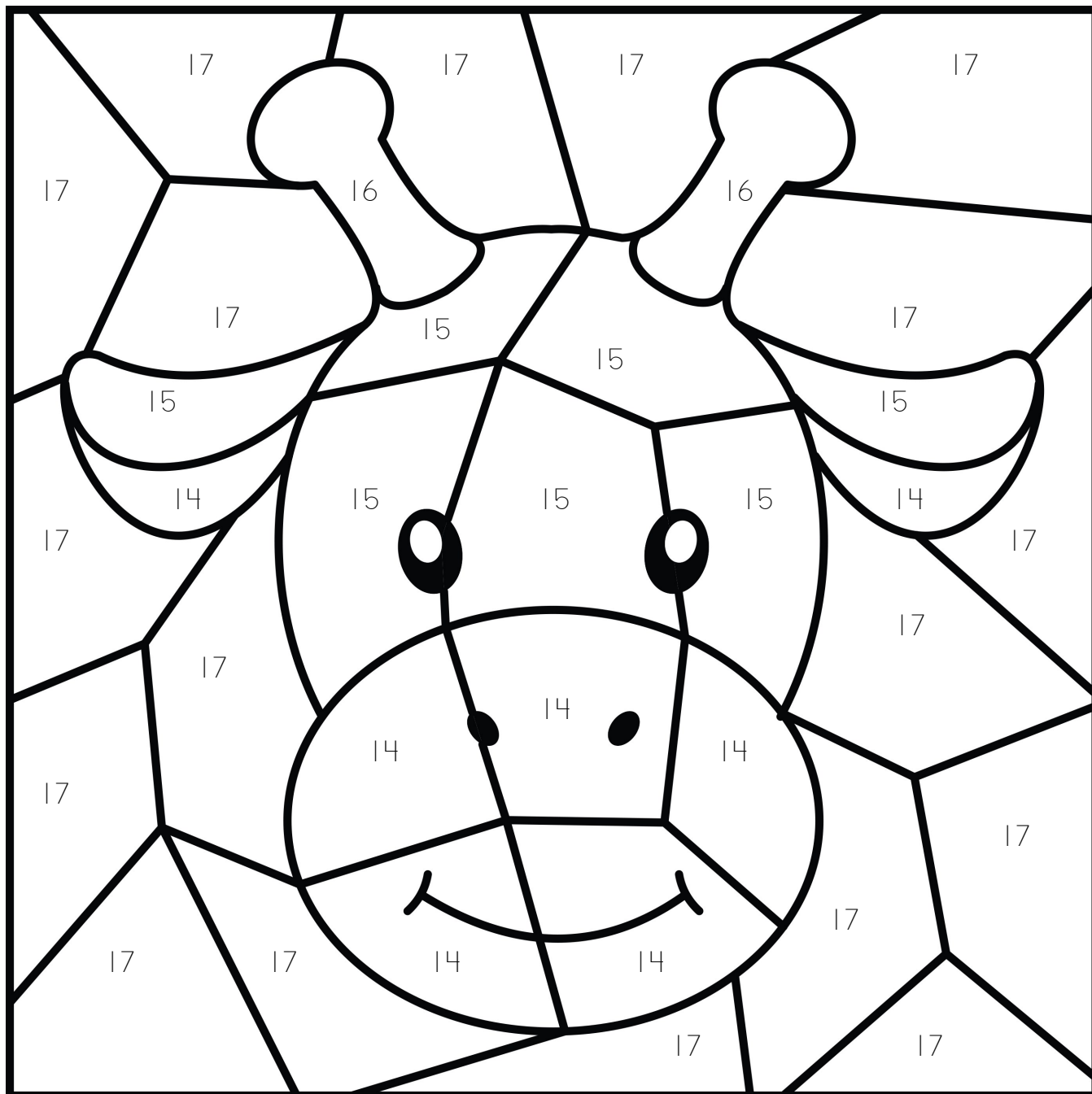

Follow the directions to color the picture.

Color the spaces with a 14 light brown ●.

Color the spaces with a 15 brown ●.

Color the spaces with a 16 black ●.

Color the spaces with a 17 red ●.

Color by Animal

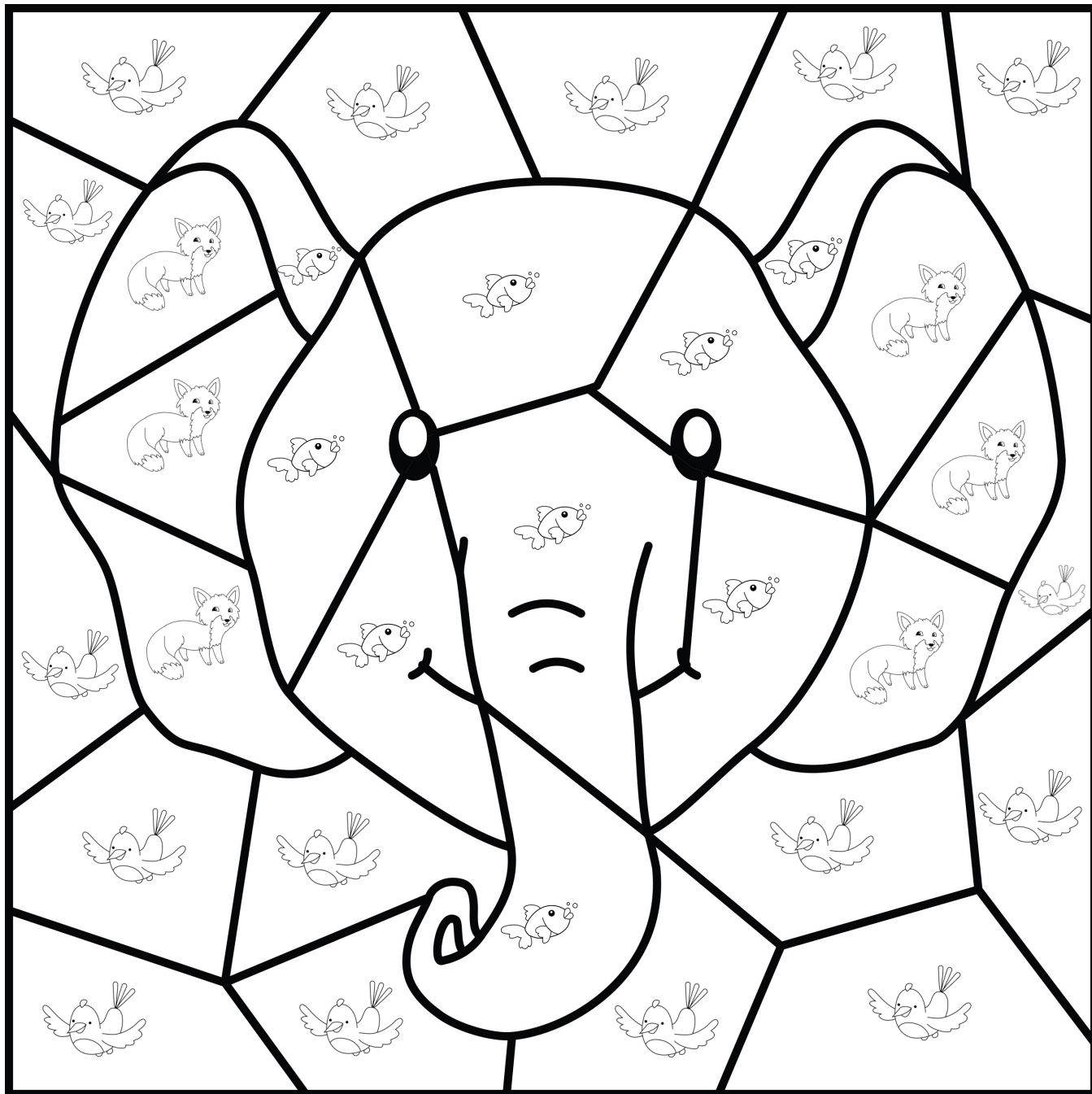

Follow the directions to color the picture.

Color the spaces with a fox  pink .

Color the spaces with a fish  gray .

Color the spaces with a bird  blue .

Color by Word

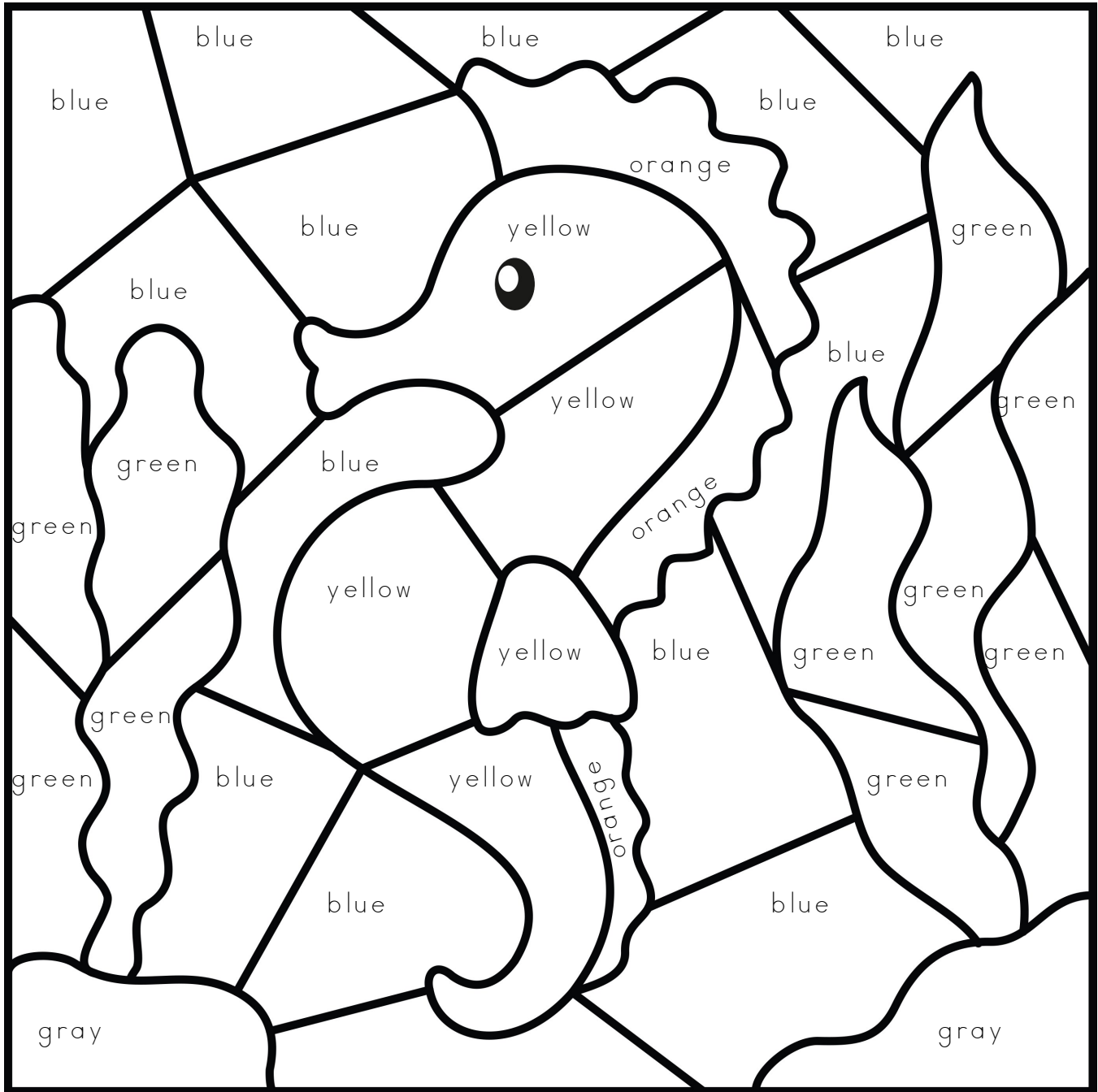

Follow the directions to color the picture.

Color the spaces with the word yellow, yellow ●.

Color the spaces with the word green, green ●.

Color the spaces with the word blue, blue ●.

Color the spaces with the word orange, orange ●.

Color the spaces with the word gray, gray ●.

Cat Tracing

Trace the lines to draw the cat. You can color the picture if you like.

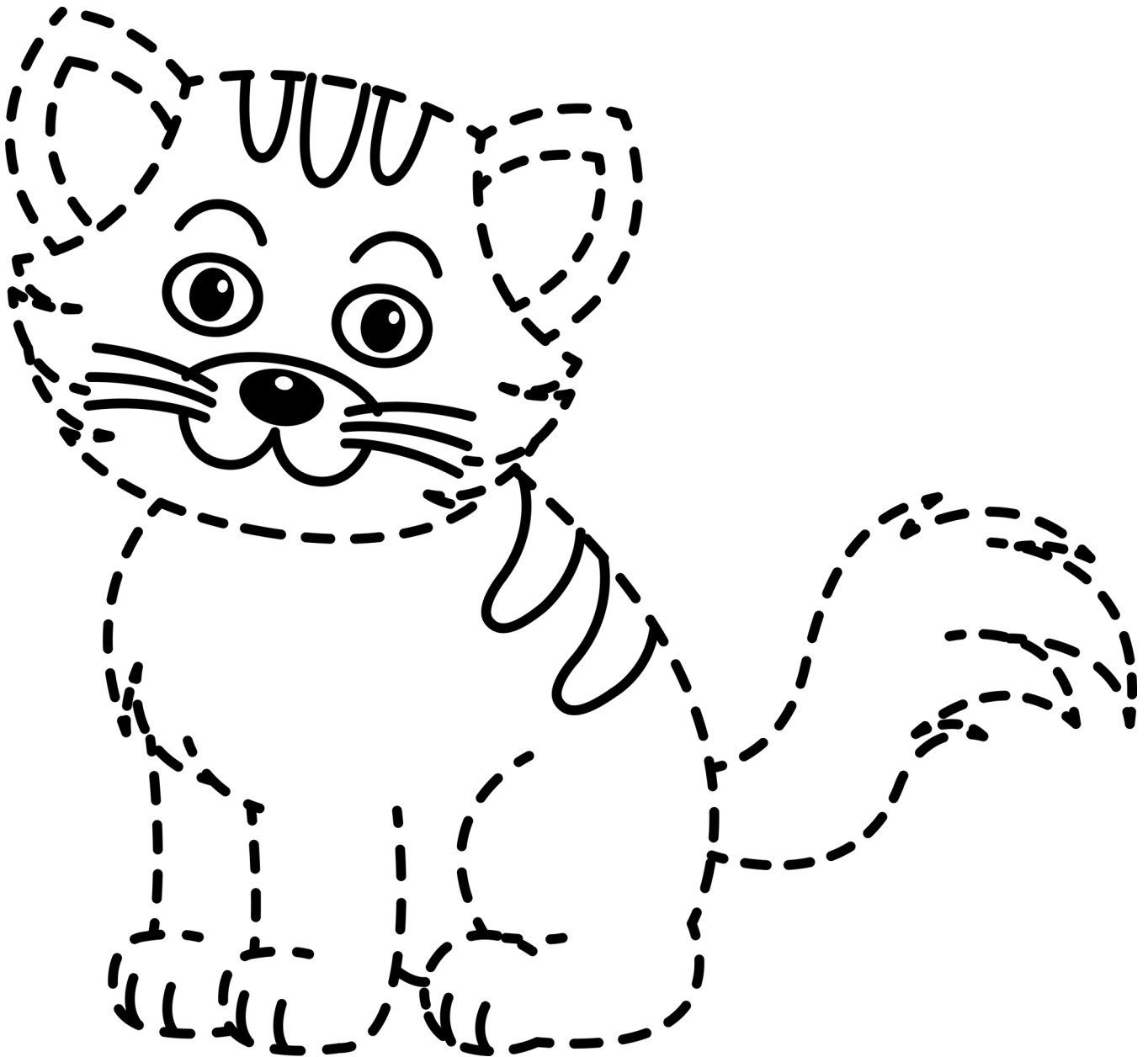

Dog Tracing

Trace the lines to draw the dog. You can color the picture if you like.

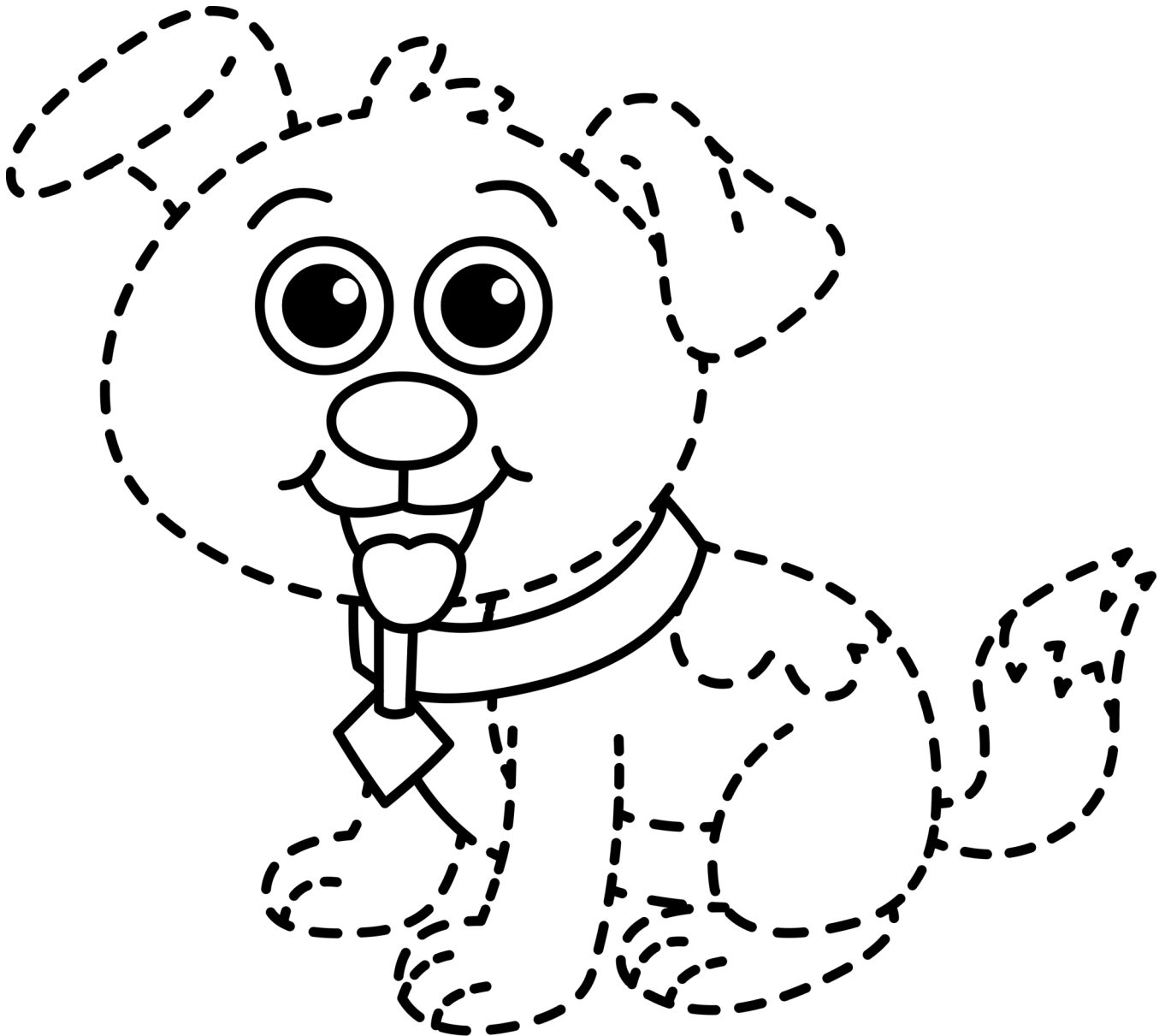

Zebra Tracing

Trace the lines to draw the zebra. You can color the picture if you like.

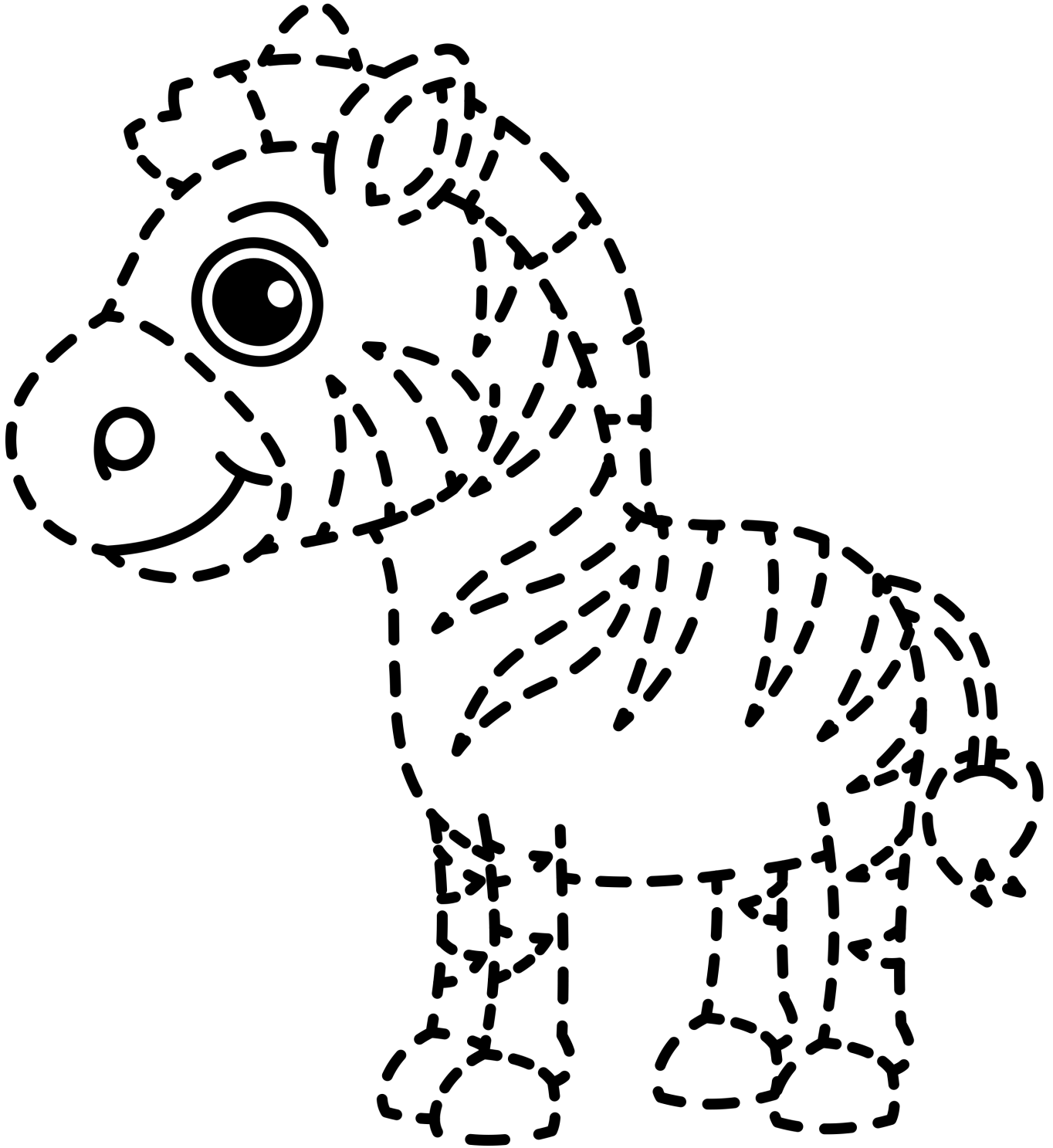

Seal Tracing

Trace the lines to draw the seal. You can color the picture if you like.

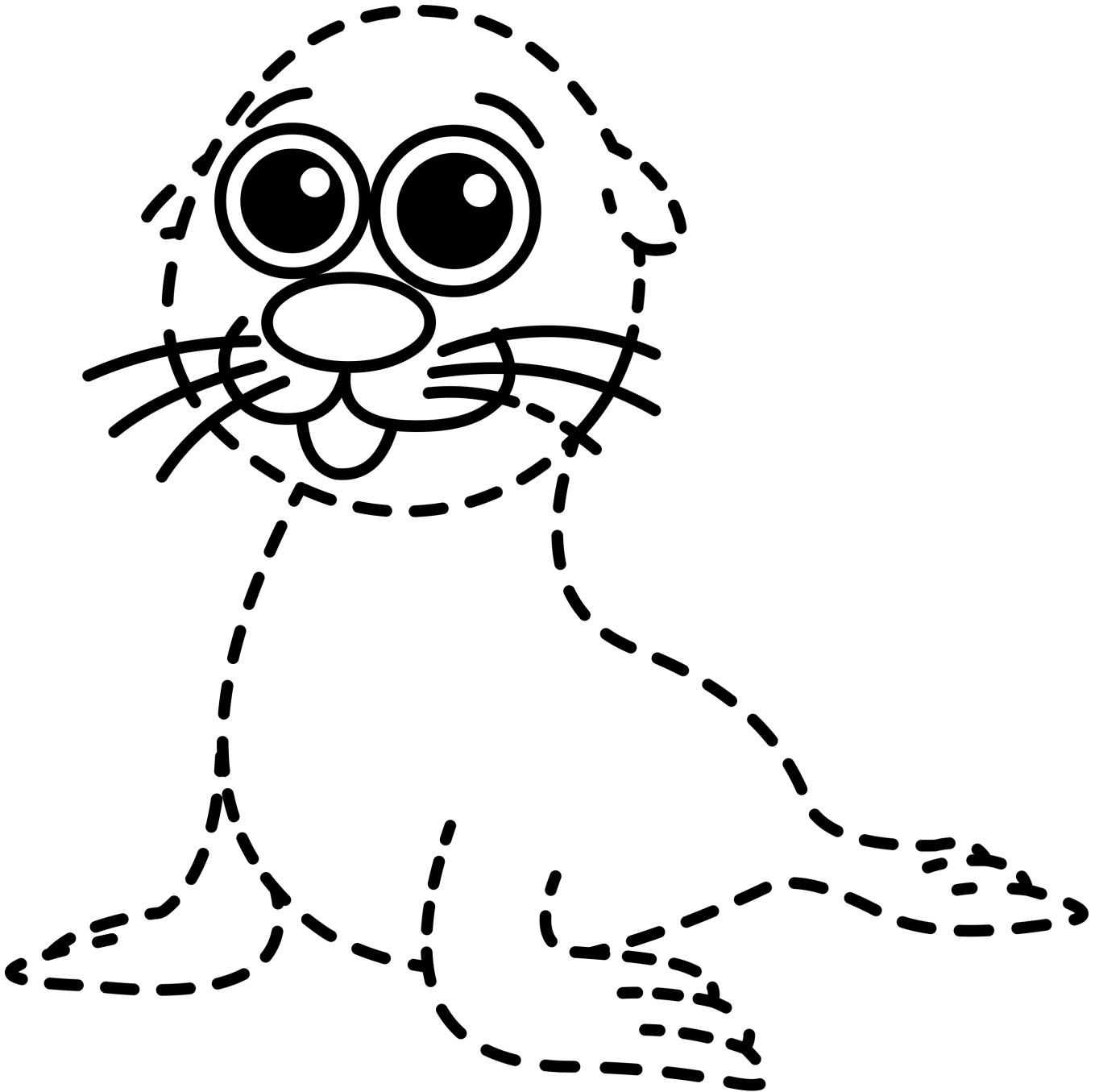

Dot the Cat

Use a dauber to make the picture of the cat. You can color the rest of the picture if you like.

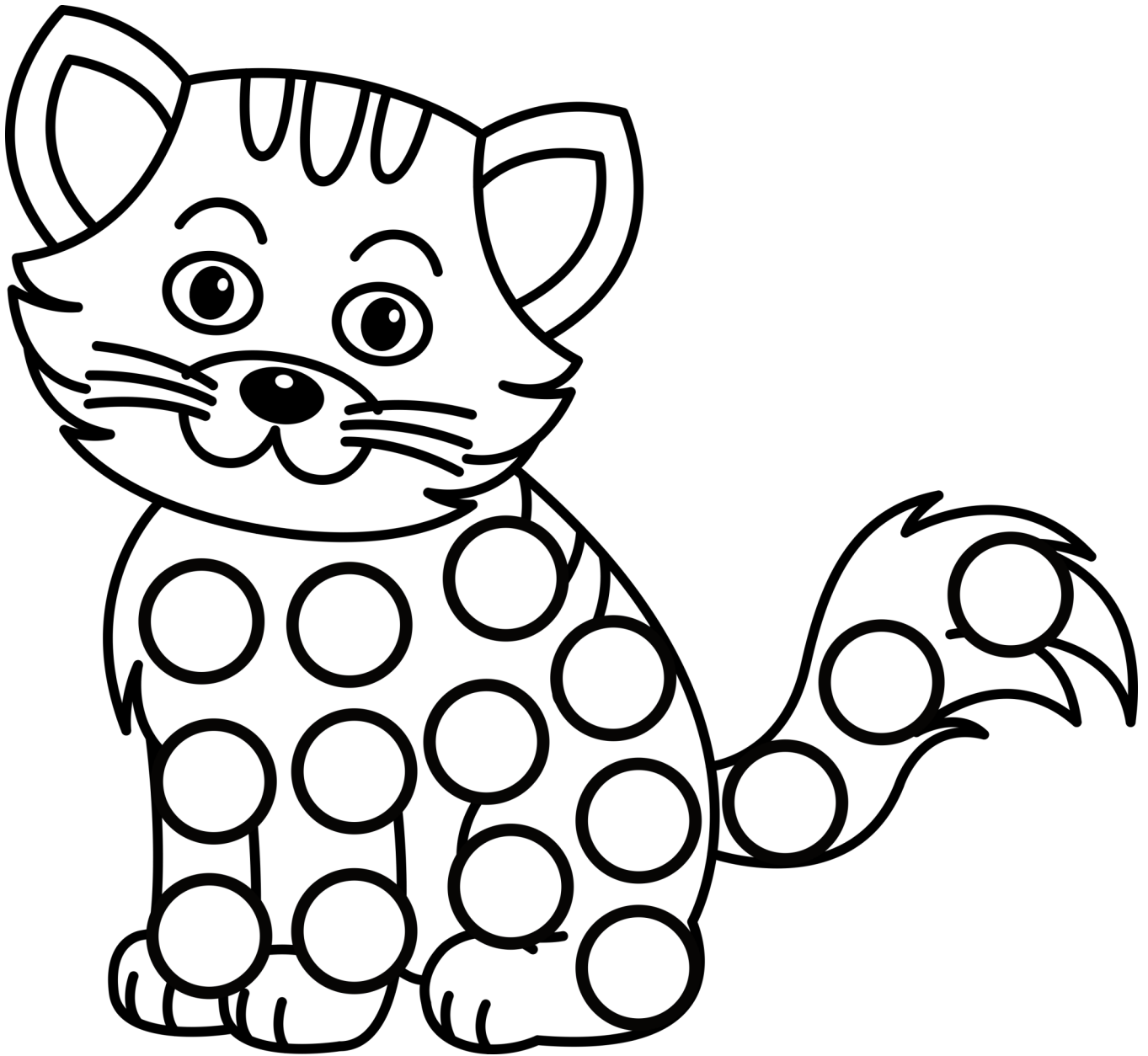

Dot the Dog

Use a dauber to make the picture of the dog. You can color the rest of the picture if you like.

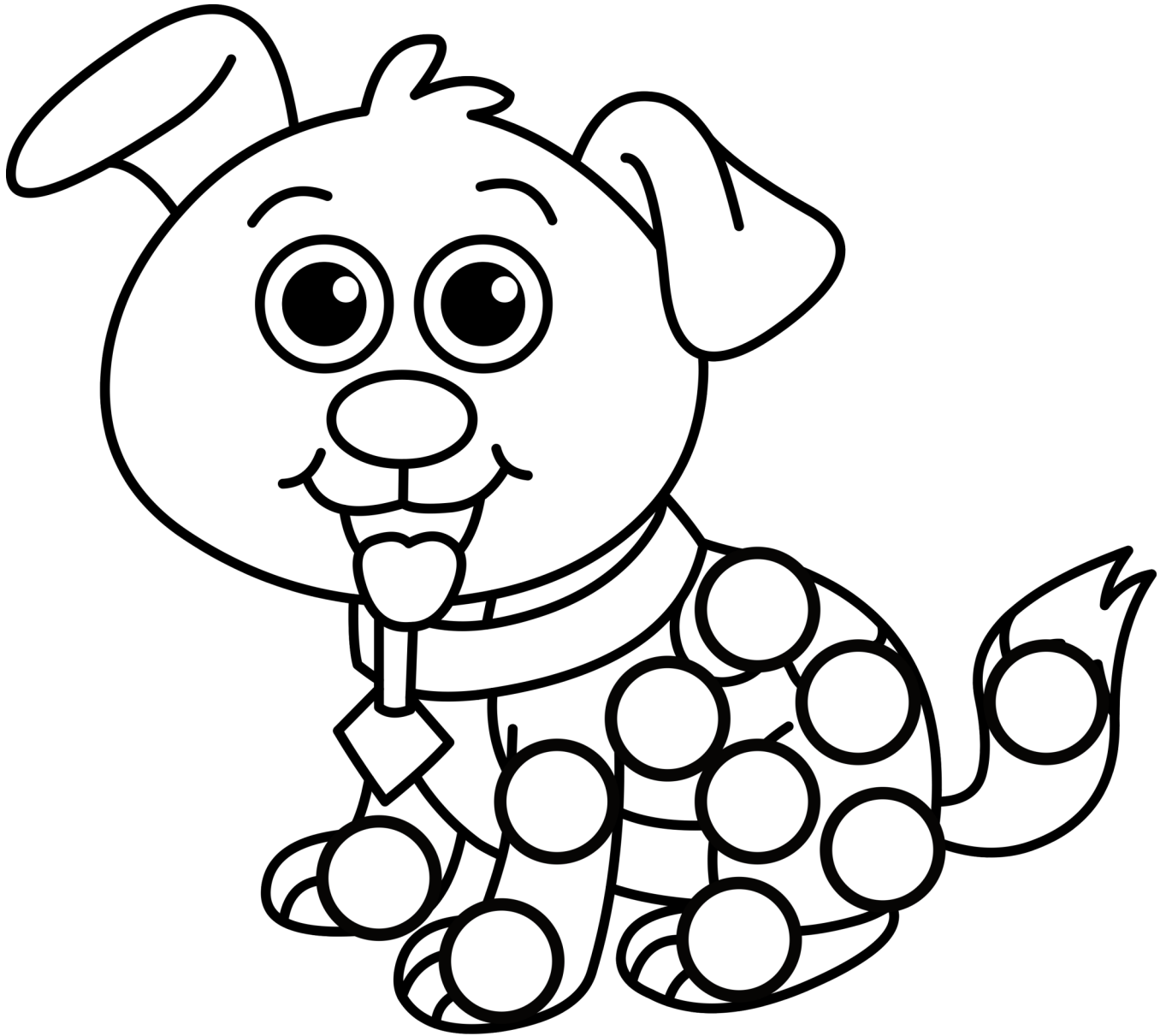

Dot the Seal

Use a dauber to make the picture of the seal. You can color the rest of the picture if you like.

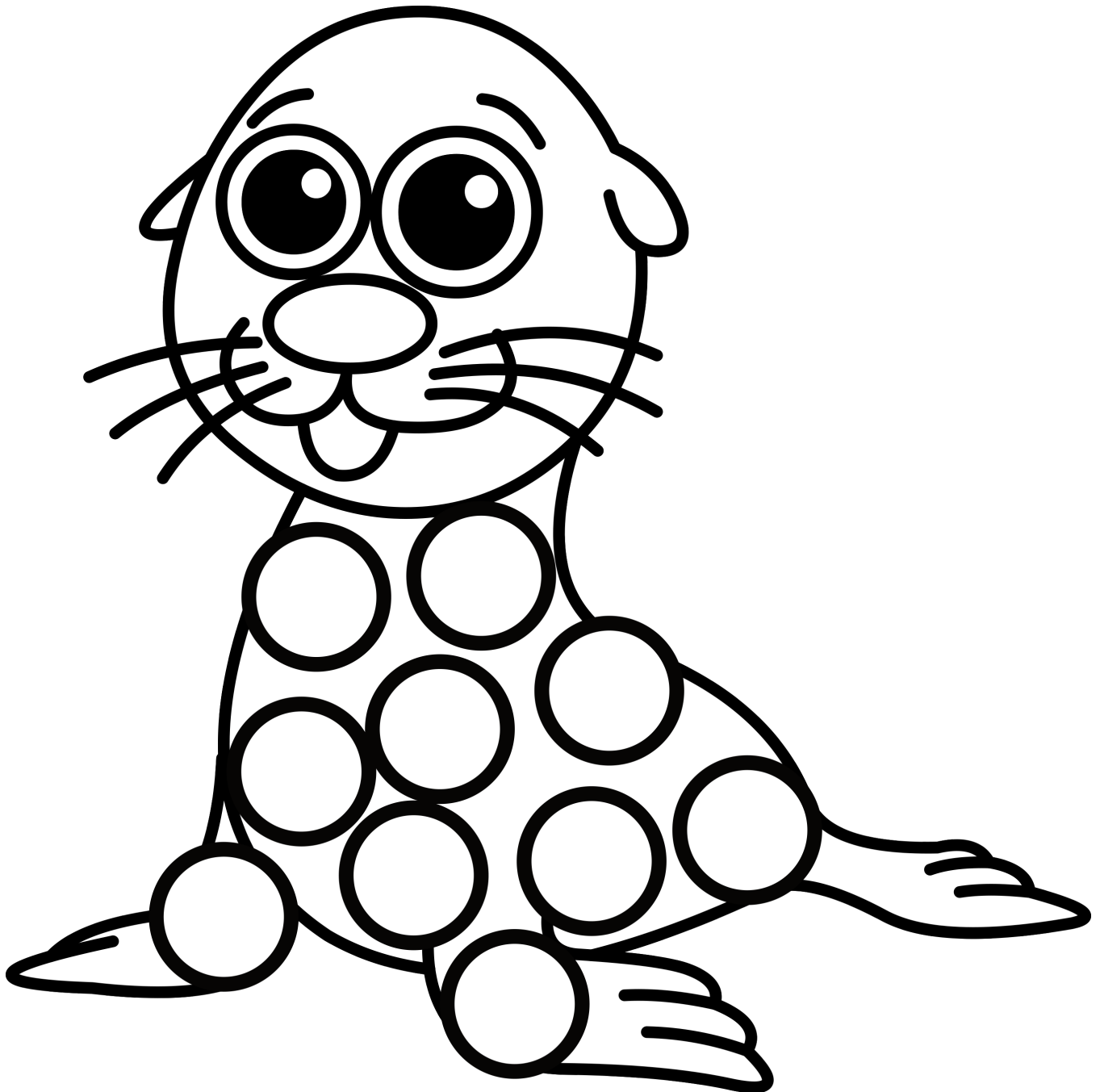

Count the Bees

These hives have lots of busy bees around them. Count the bees around each hive. Under the hive are three numbers. Circle the number that shows how many bees are around the hive.

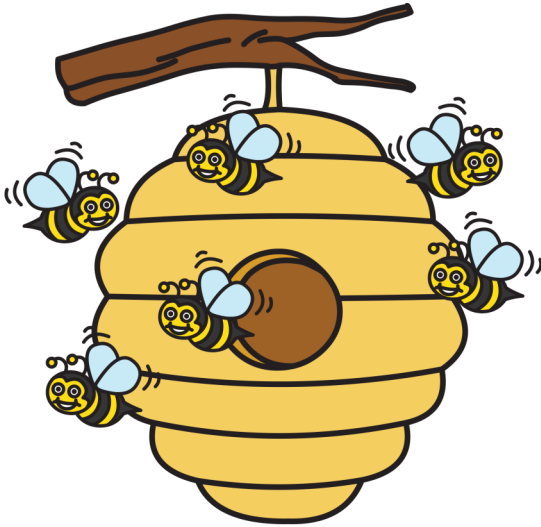

6 10 7

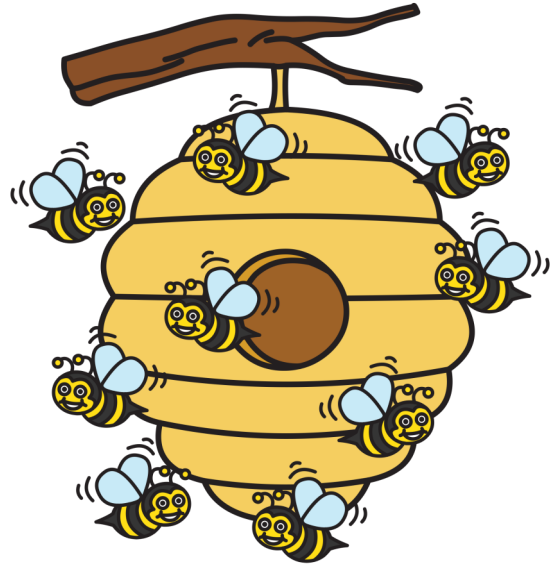

4 9 12

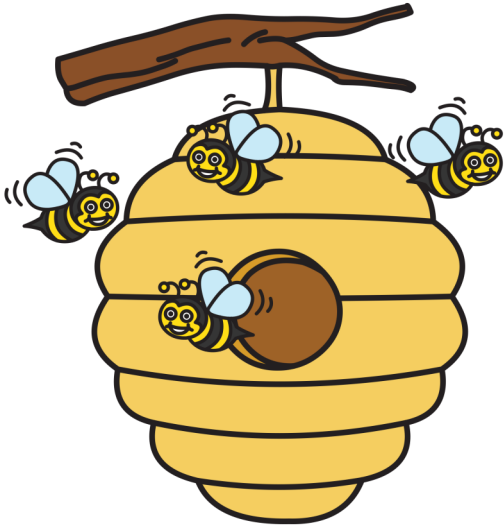

5 4 7

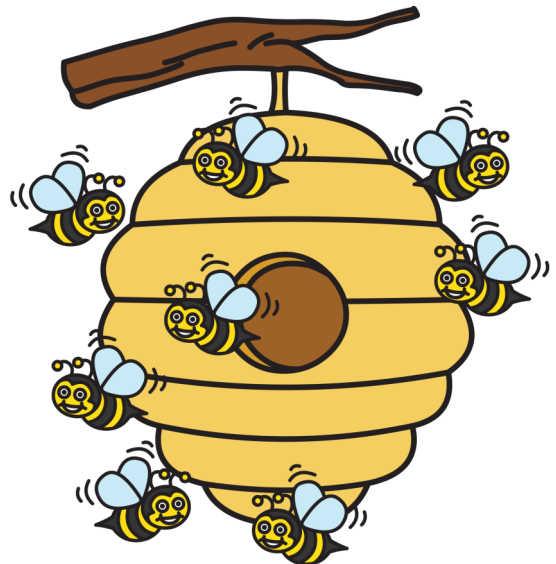

11 5 8

Count the Fleas

This poor dog has fleas. Count the fleas on each dog. Under the dog are three numbers. Circle the number that shows how many fleas are on the dog.

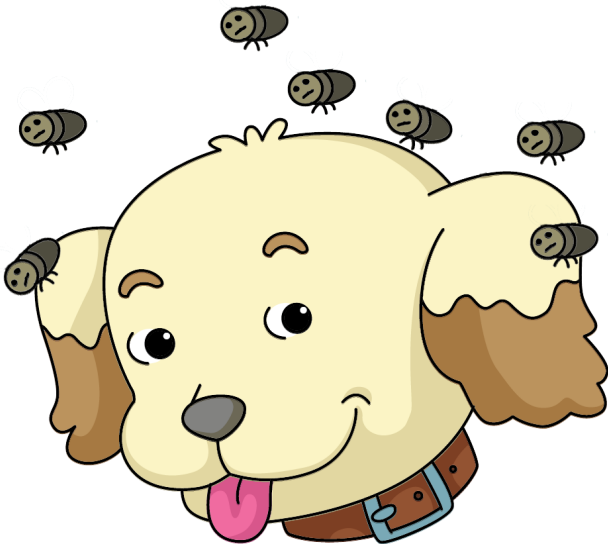

5 7 9



1 2 3

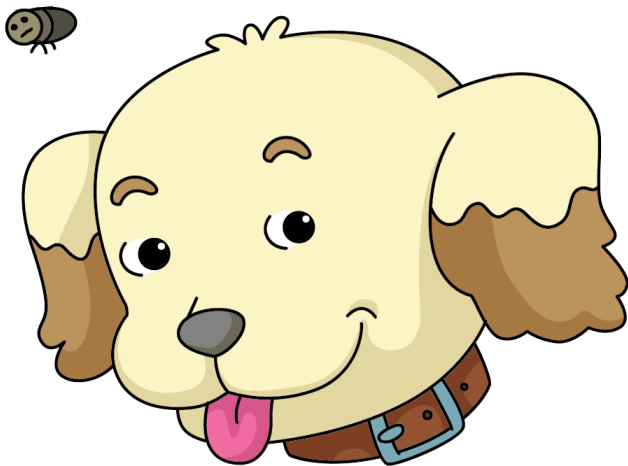

1 3 5



6 8 10

Matching Cloud Shapes

Match the animal to the cloud shape that looks like it.

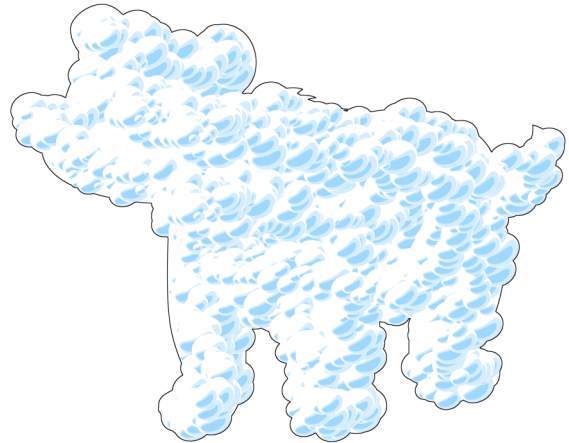
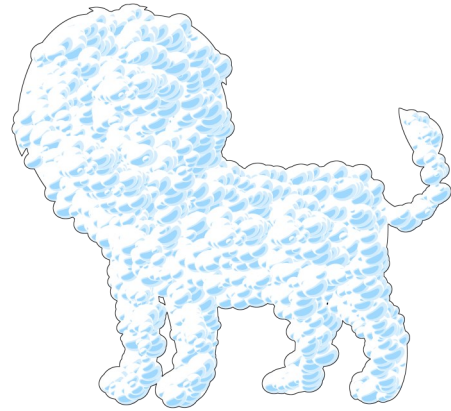

What Comes Next?

Look at each row of animals below. At the end, there is a space where the next animal is missing. Draw a circle around the animal that goes next in the row.

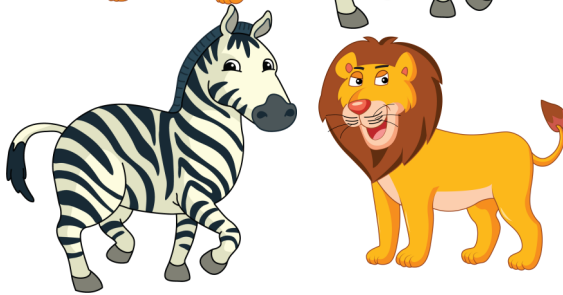
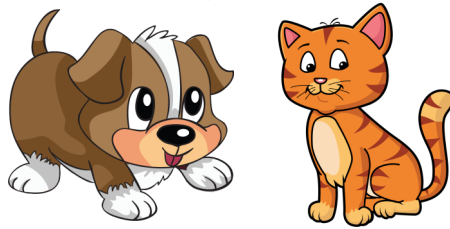

Color by Rhyme

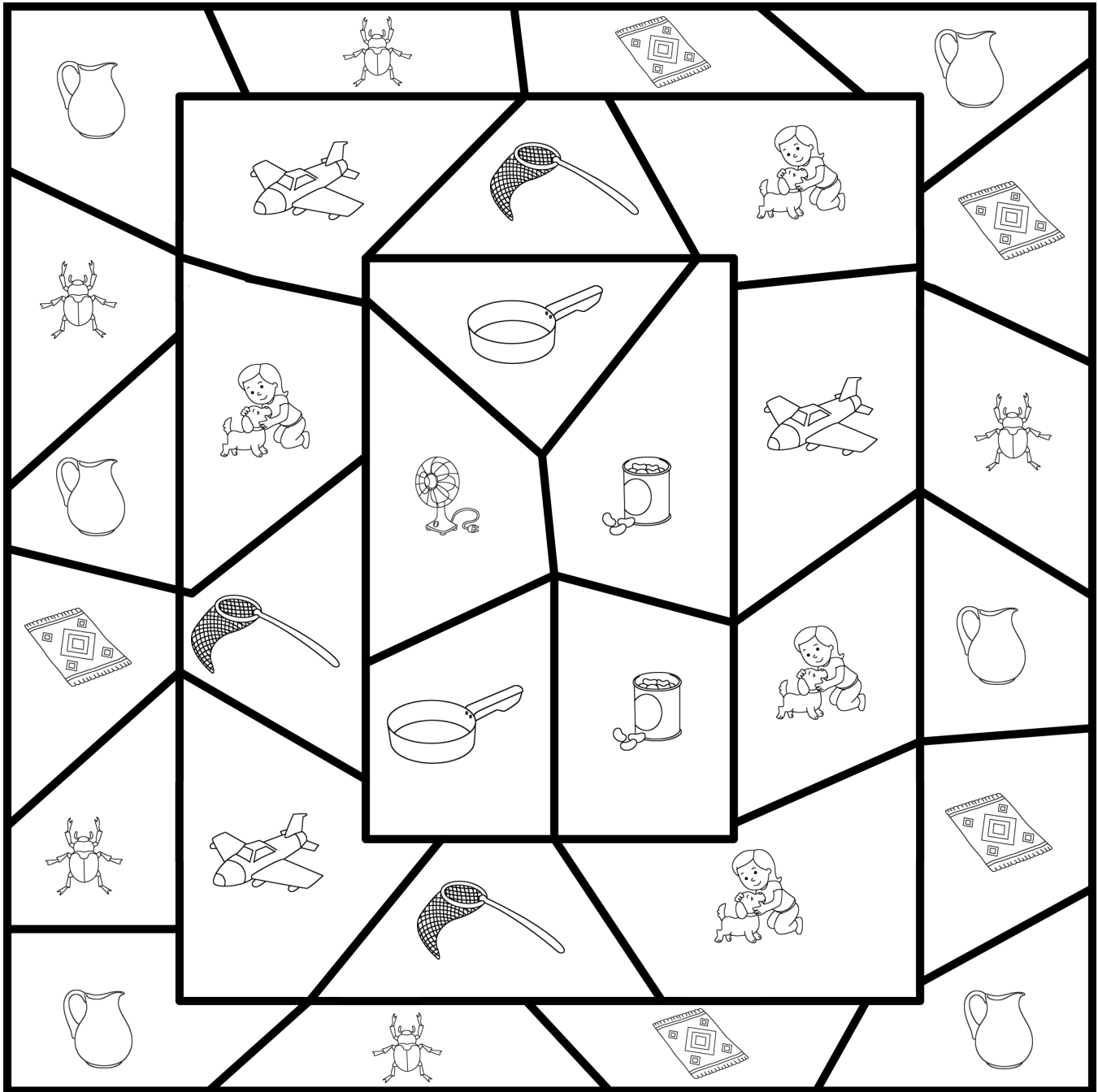

Follow the directions to color the picture.

If the word rhymes with hug  color the space red ●.

If the word rhymes with wet  color the space blue ●.

If the word rhymes with van  color the space purple ●.

Did you know if you mix red ● and blue ● together, you get purple ● ?

Color by Rhyme Key



van



wet



can



jet



fan

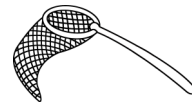

net



pan



pet



hug



jug

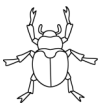

bug

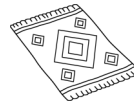

rug

Color by Shape

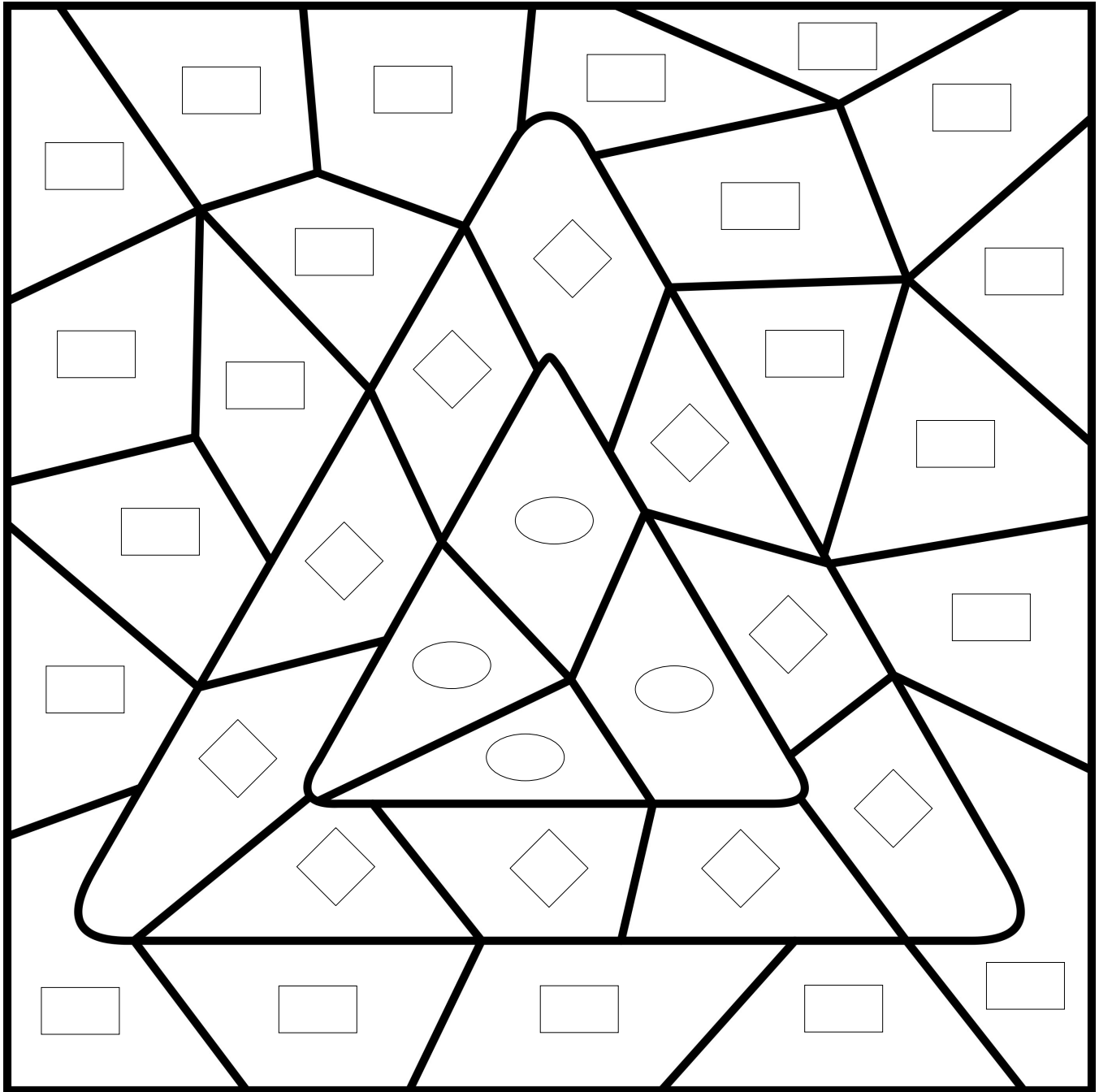

Follow the directions to color the picture.

Color the spaces with a diamond  red .

Color the spaces with a rectangle  yellow .



Color the spaces with an oval  orange .

Did you know if you mix yellow  and red  together, you get orange .

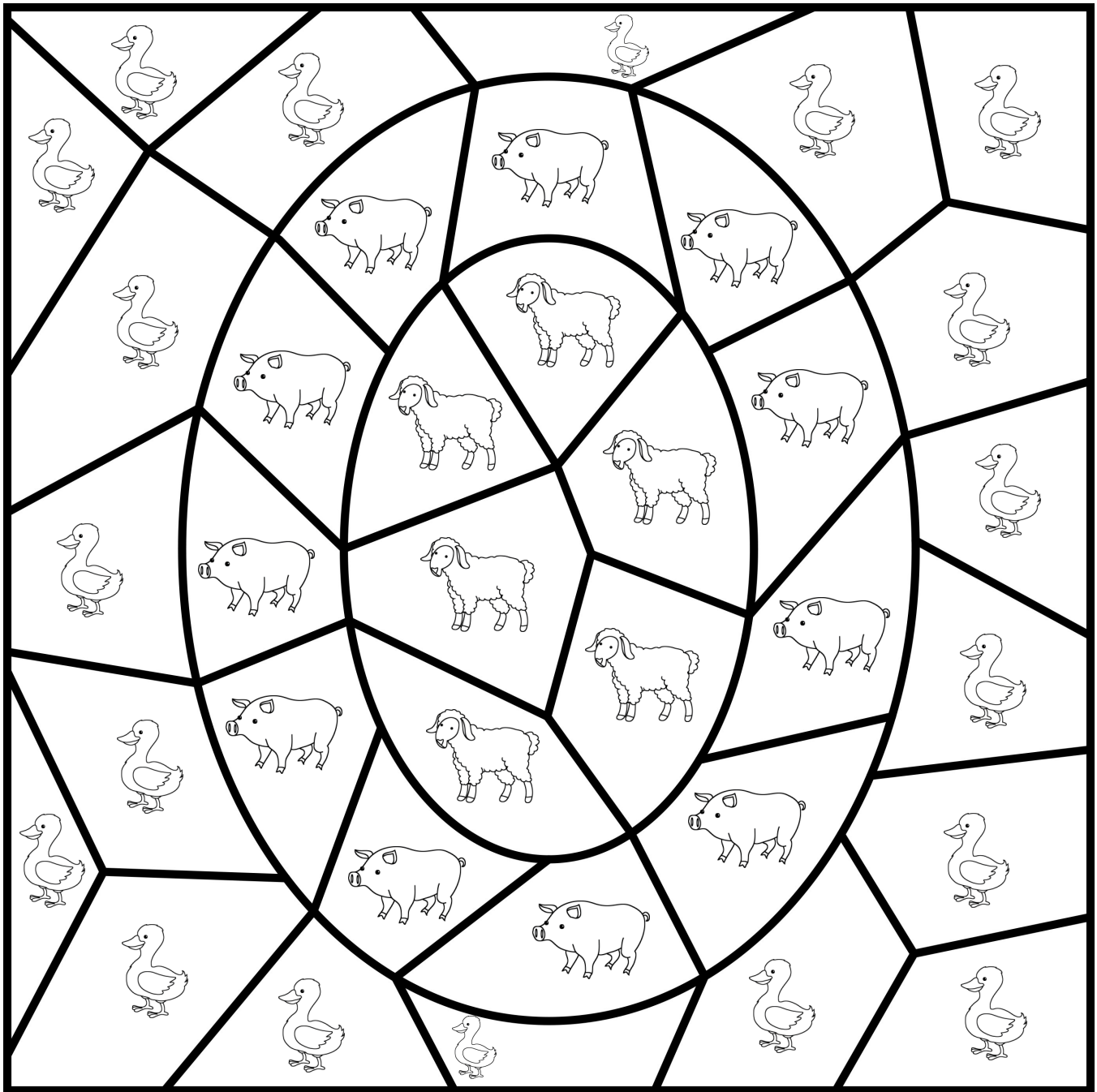
Color by Animal





Follow the directions to color the picture.

Color the spaces with a duck  blue .

Color the spaces with a pig  yellow .

Color the spaces with a sheep  green .

Did you know if you mix blue  and yellow  together, you get green  ?

Color by Word

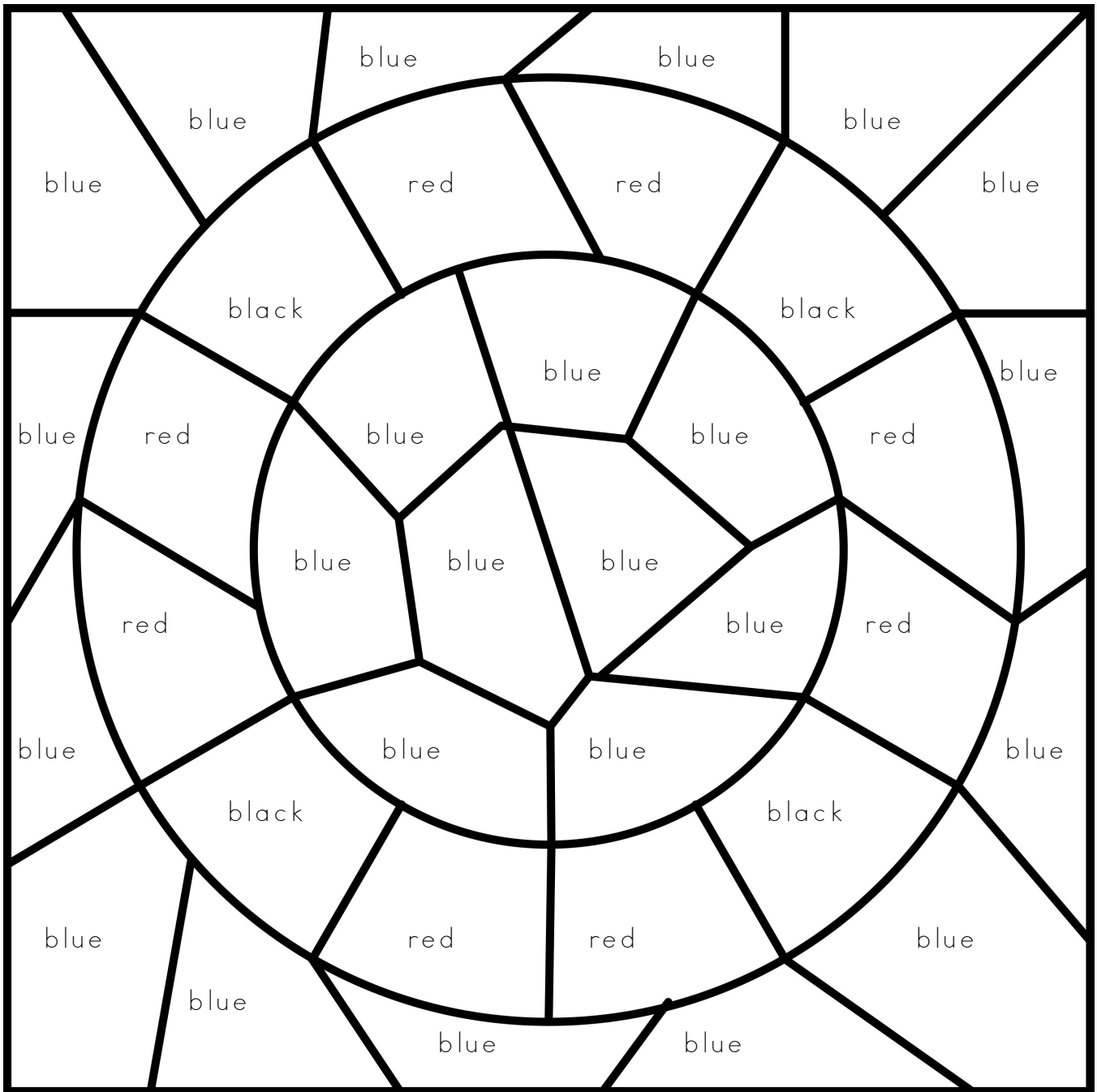

Follow the directions to color the picture.

Color the spaces with the word blue, blue .

Color the spaces with the word red, red .

Color the spaces with the word black, black .

Shape Tracing

Trace the lines to draw the shapes. You can color the shapes if you like.

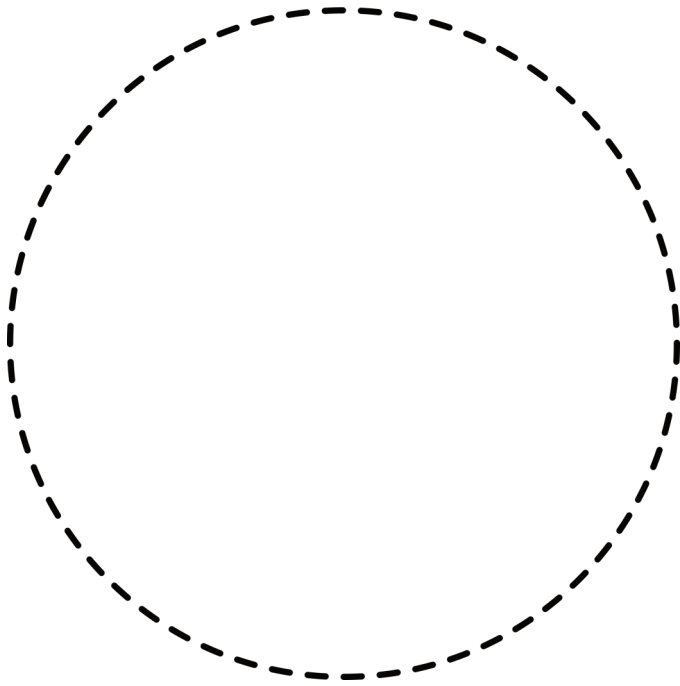

Circle

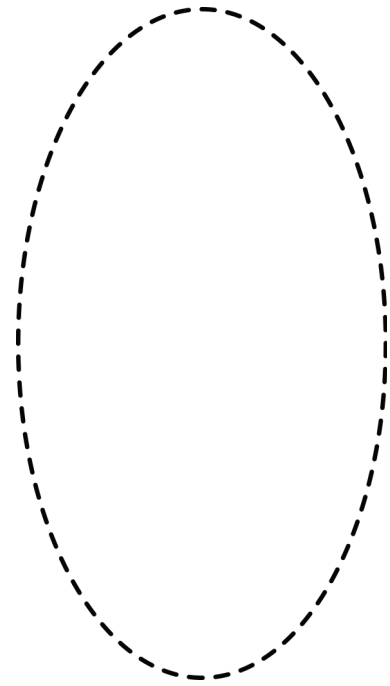

Oval

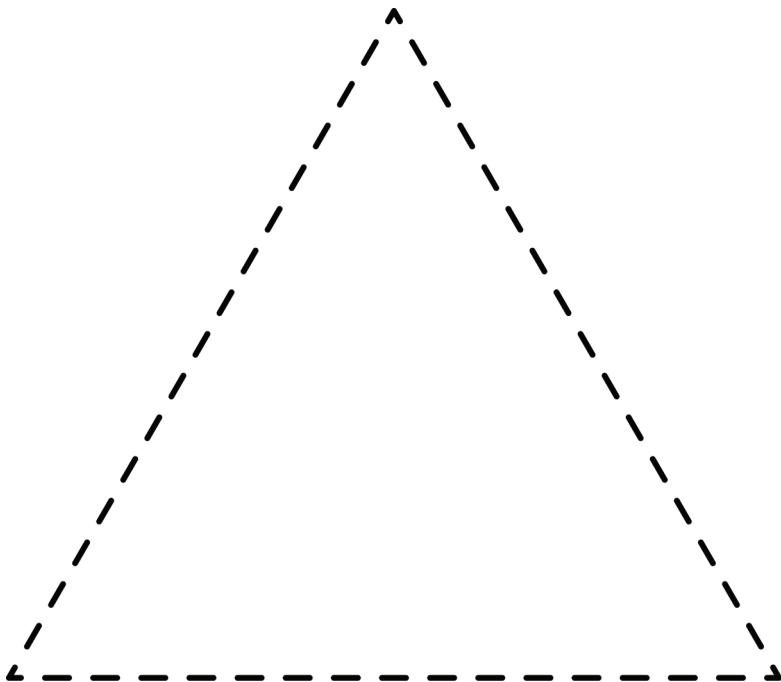

Triangle

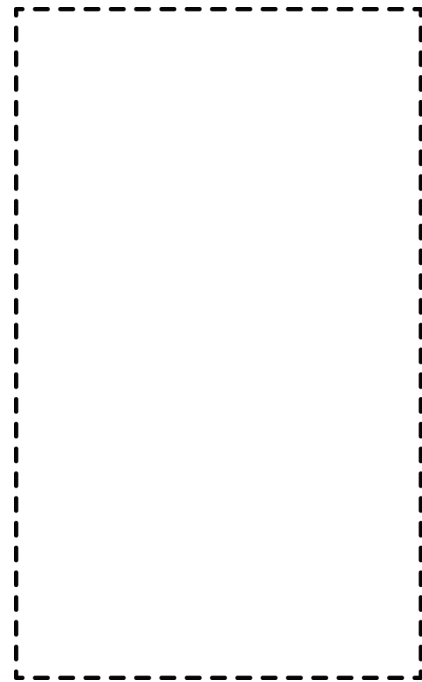

Rectangle

Dot the Circle

Use a dauber to make the picture of the circle. Imagine the circle is a group of people watching something going on in the middle. Draw something in the circle the people could be watching.

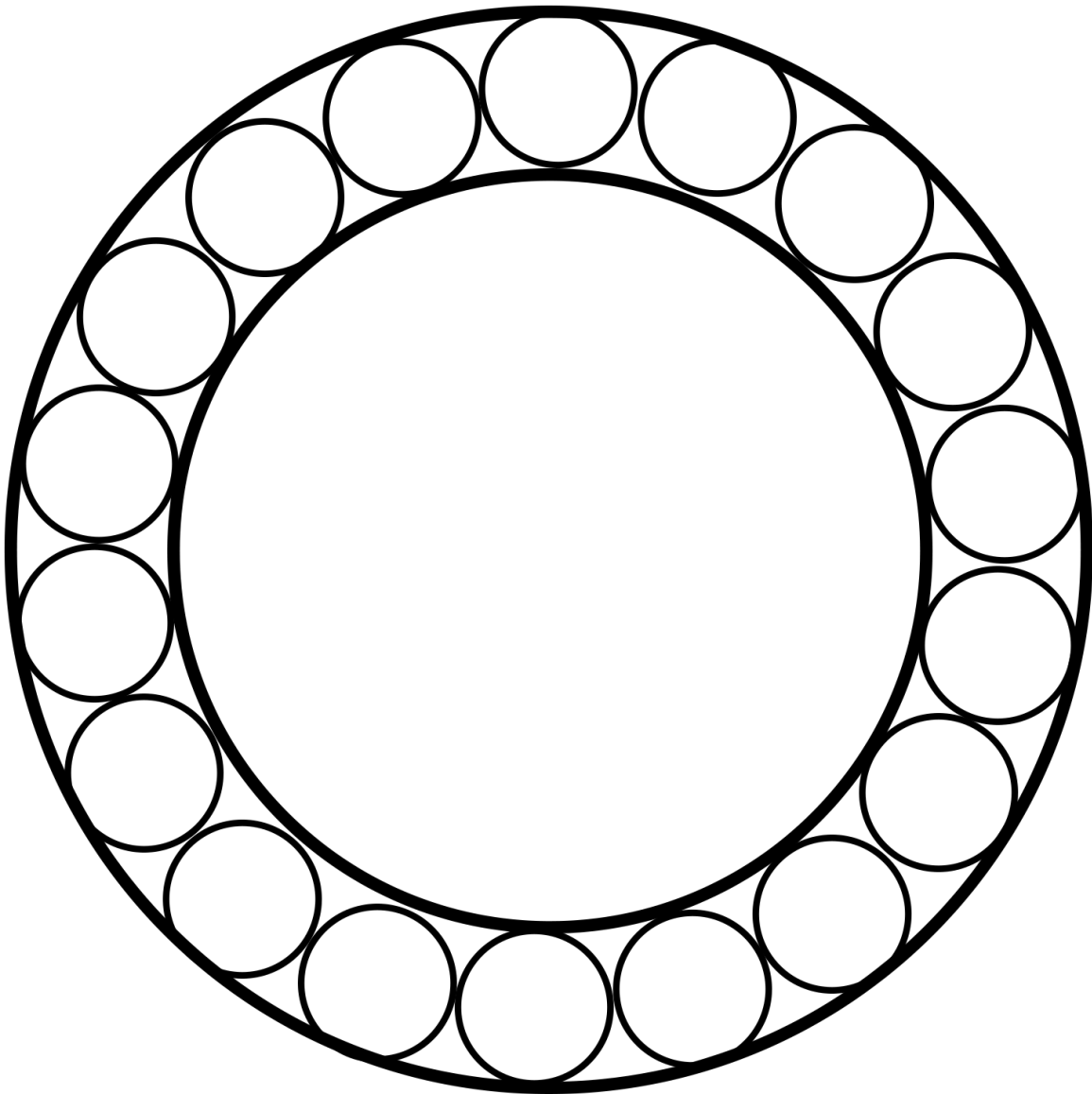

Dot the Oval

Use a dauber to make the picture of the oval. Imagine the oval is a picture frame. Draw a picture in the oval of something you would like to put in the frame.

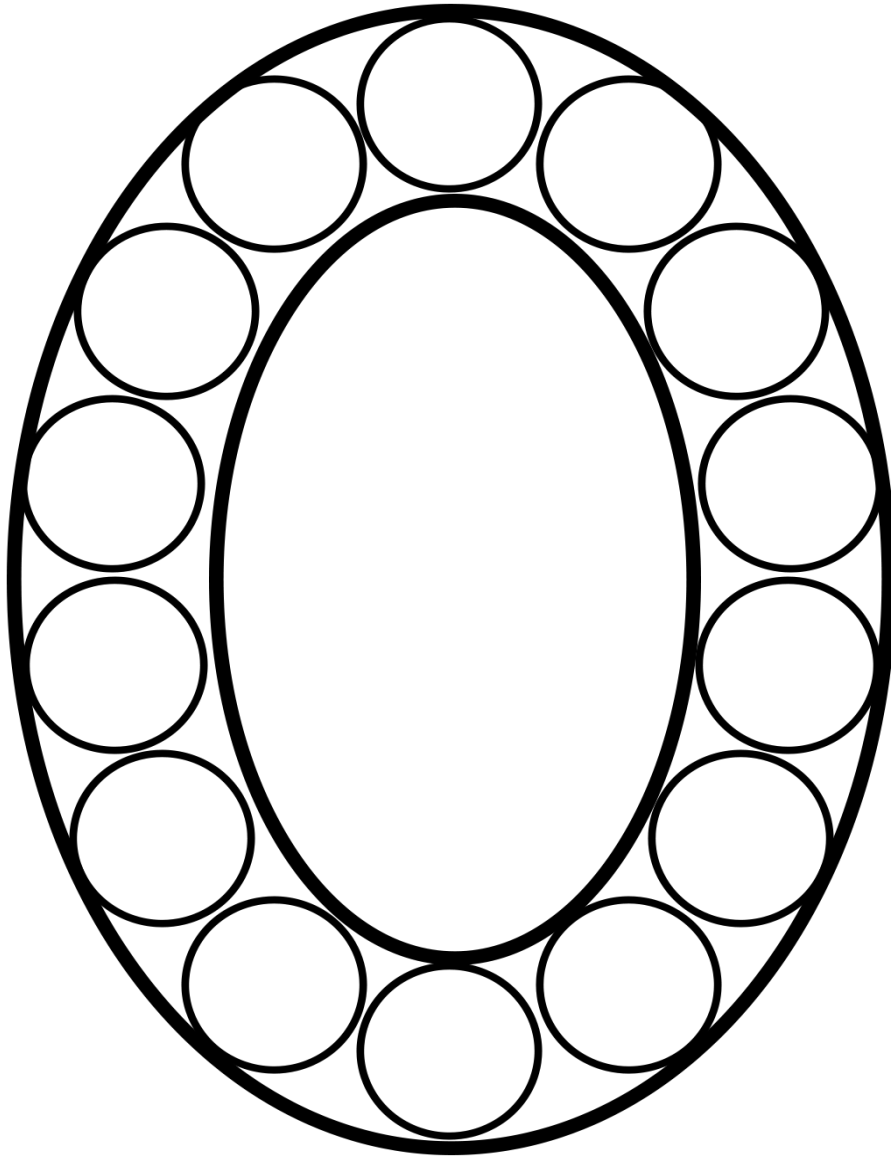

Dot the Rectangle

Use a dauber to make the picture of the rectangle. Imagine the rectangle is a window. Draw something in the rectangle you can see outside of a window.

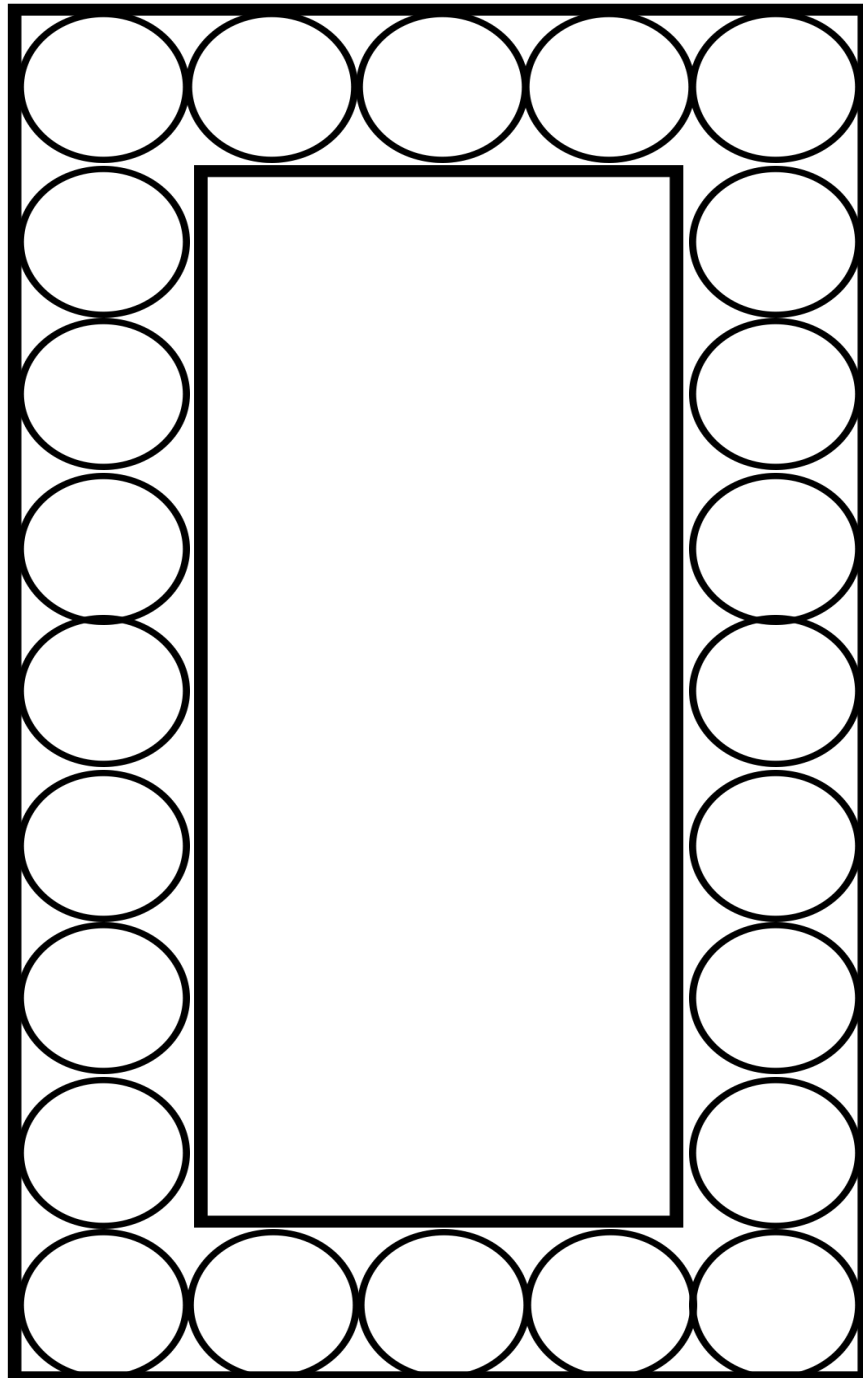

Dot the Triangle

Use a dauber to make the picture of the triangle. Imagine the triangle is sign. Draw something in the triangle you would like to see on a sign along the road.

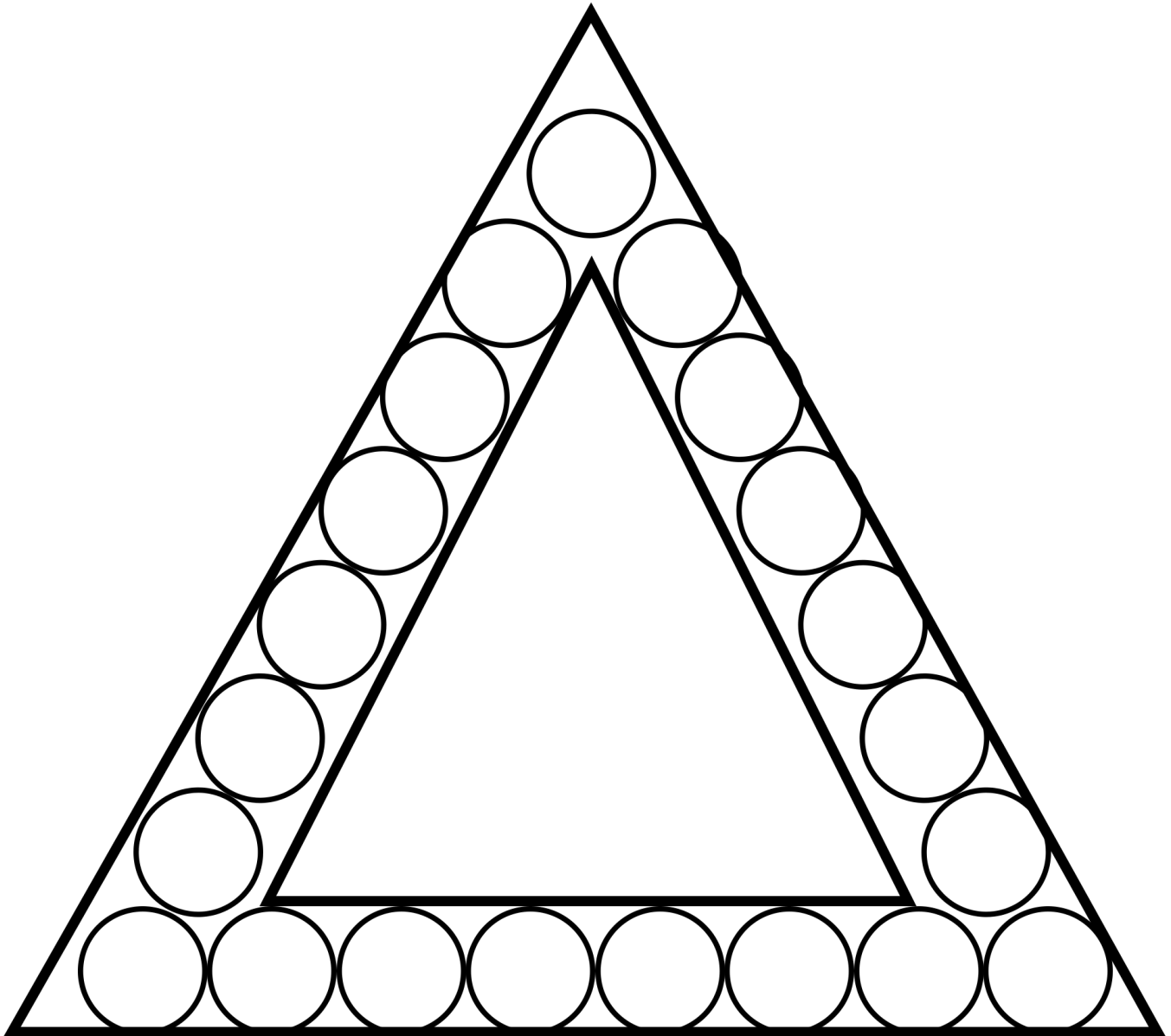

Find Your Way Triangle

When the letters to spell “triangle” left the maze, the “g” got lost. Help the “g” find its way through the maze and then write the “g” in its space in the word.

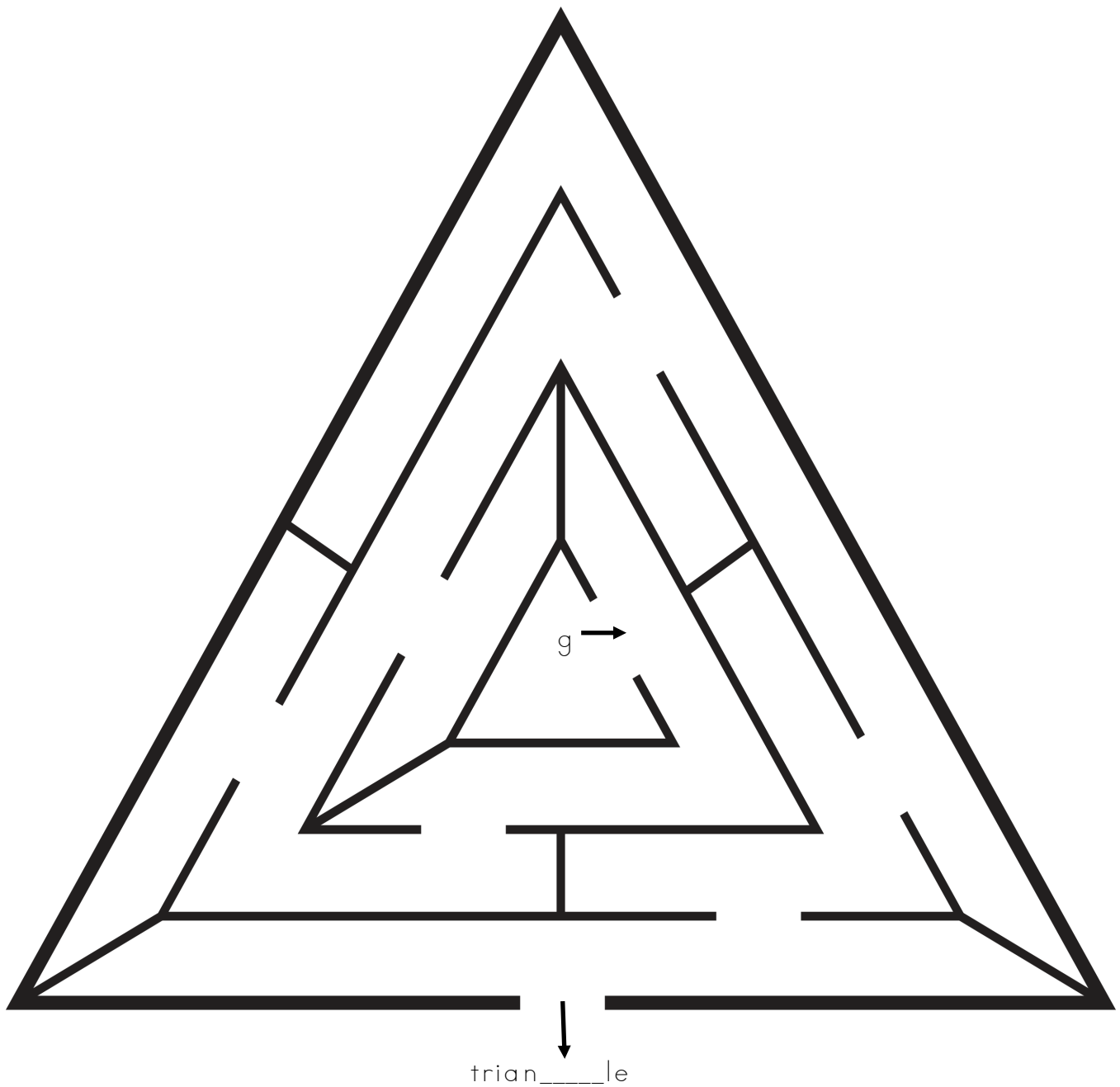

Find Your Way Oval

When the letters to spell “oval” left the maze, the “o” got lost. Help the “o” find its way through the maze and then write the “o” in its space in the word.

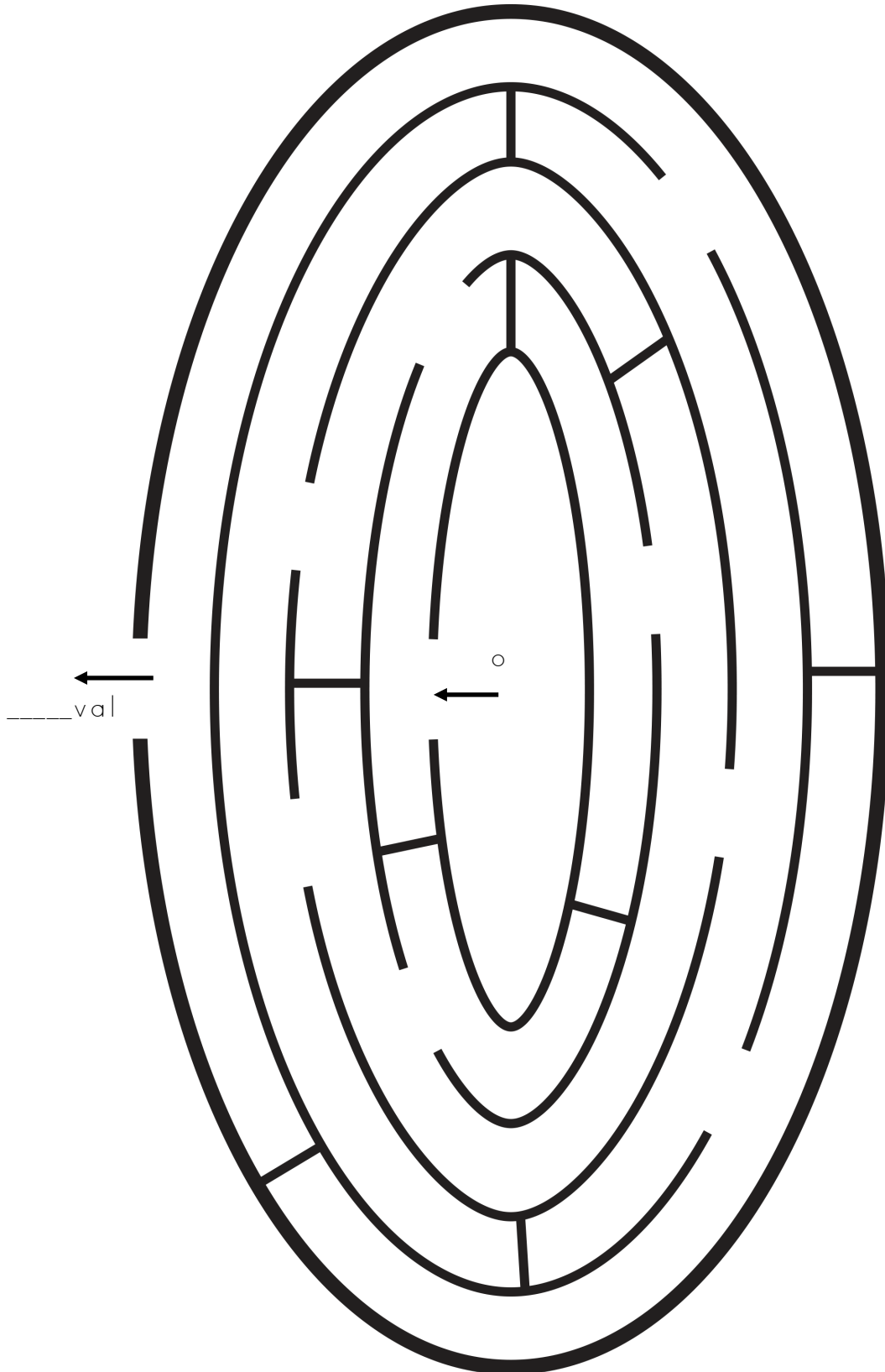

Find Your Way Circle

When the letters to spell “circle” left the maze, the “c’s” got lost. Help the “c’s” find their way through the maze and then write the “c’s” in their spaces in the word.

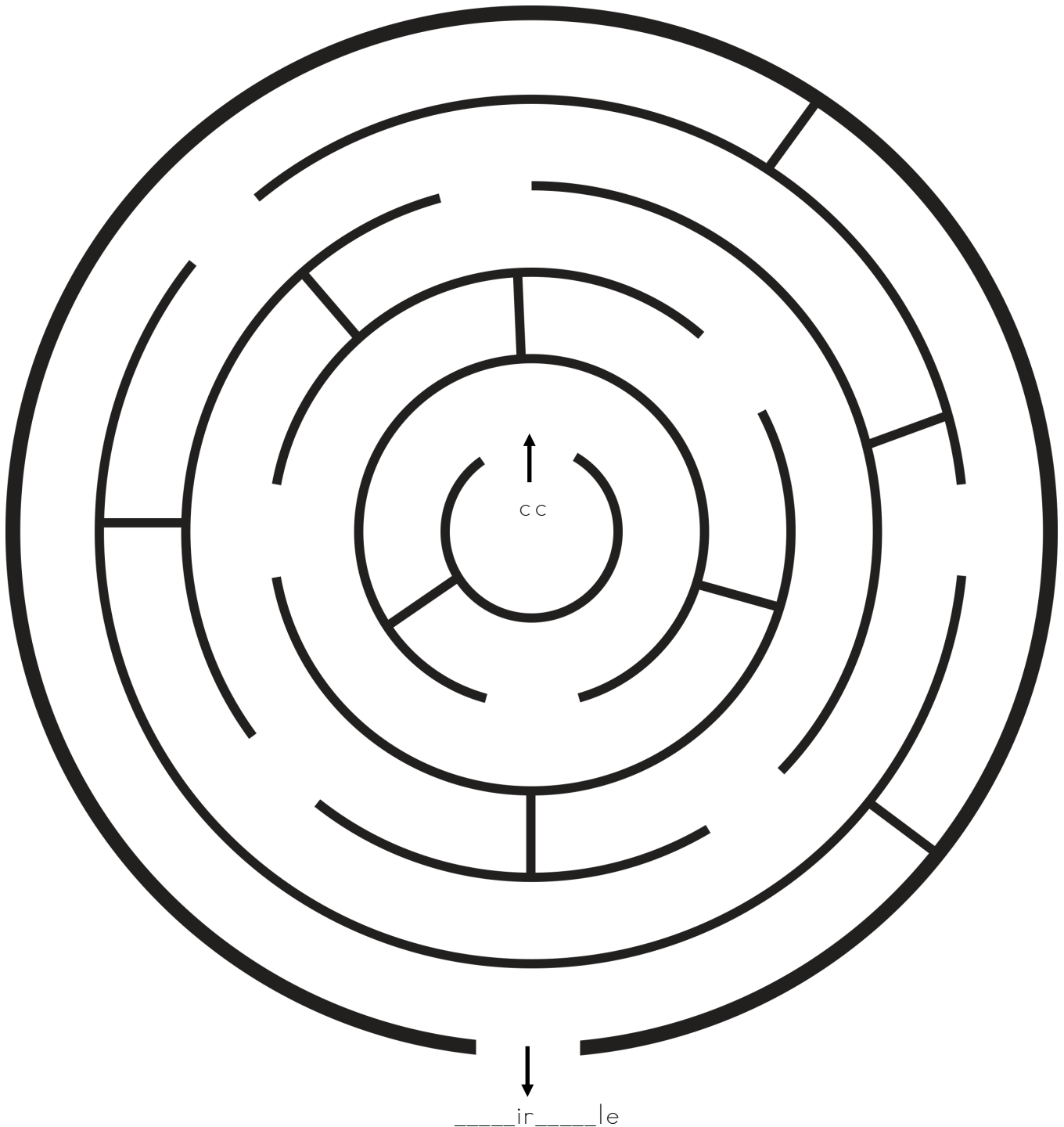

Count the Shapes

Look at the questions. They ask how many of the different shapes there are. Beside each question are three numbers. Circle the number that tells how many of that shape there are on the page.

How many circles  are there? 12 14 16

How many squares  are there? 8 11 14

How many triangles  are there? 10 12 14

How many diamonds  are there? 8 9 10

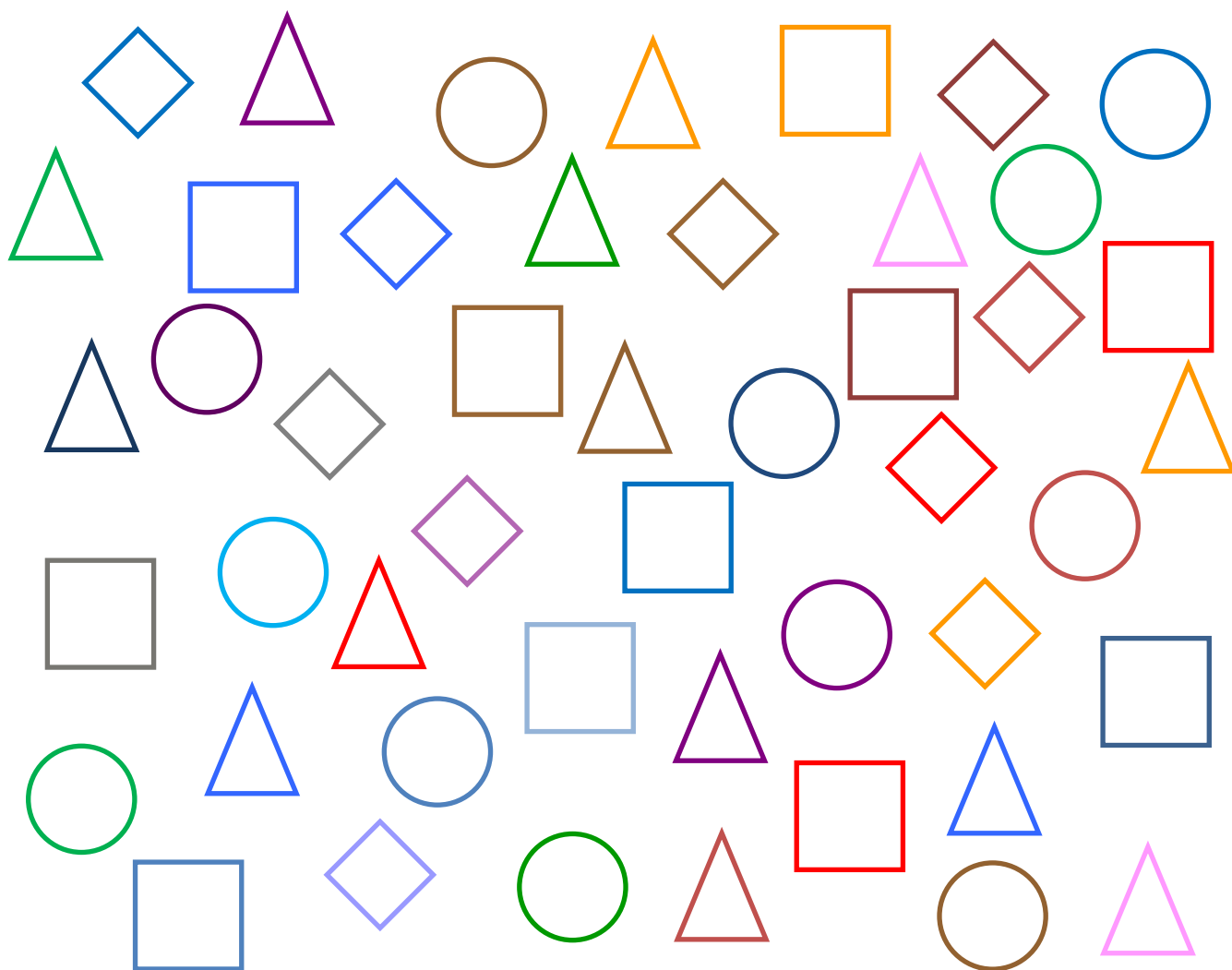



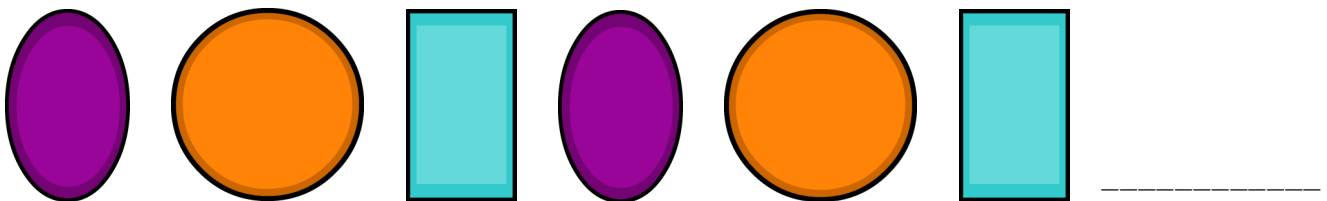
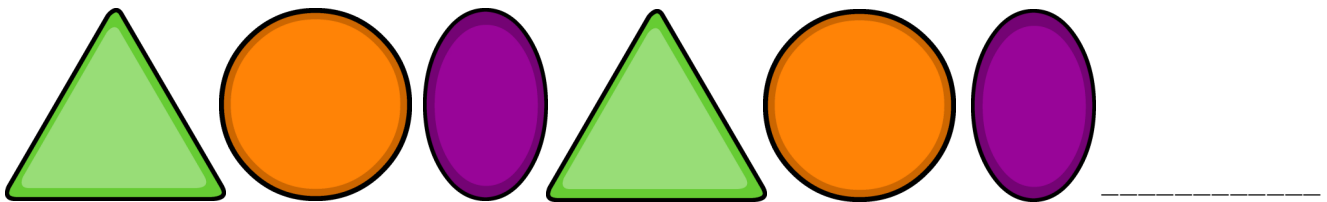
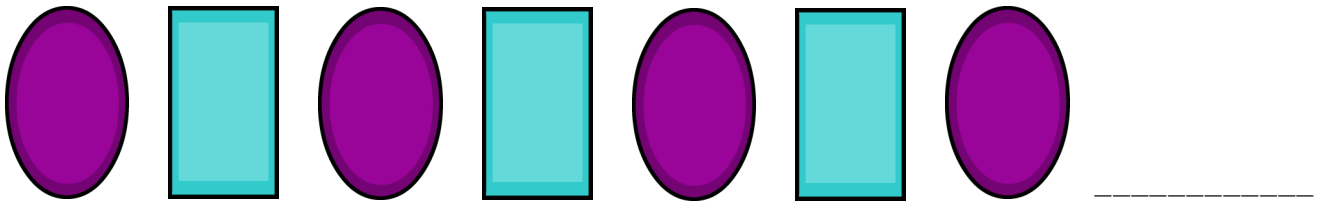
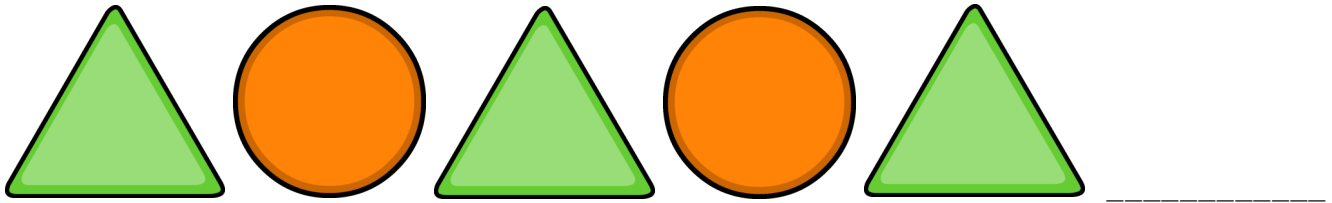

What Comes Next?

Look at each row of shapes below. At the end there is a space where the next shape is missing. Draw the shape that goes next in the row.



Spot the Shapes

Many things we use everyday have the same shapes as the shapes you have been looking at. Draw an oval  around the things that look like ovals, a circle  around the things that look like circles, a triangle  around the things that look like triangles, and a rectangle  around the things that look like rectangles.

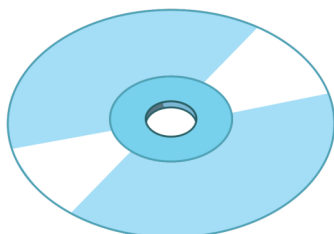
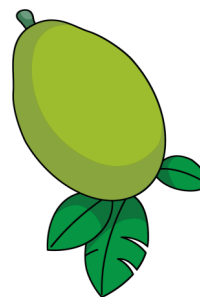
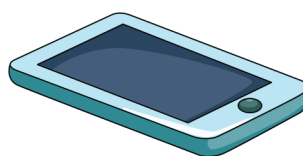
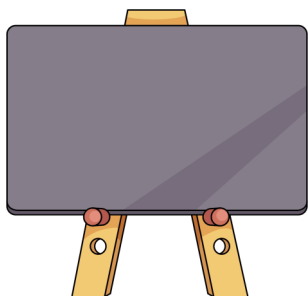
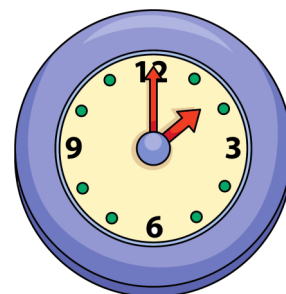
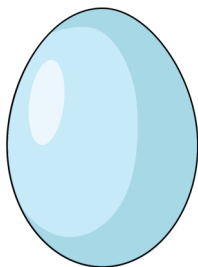
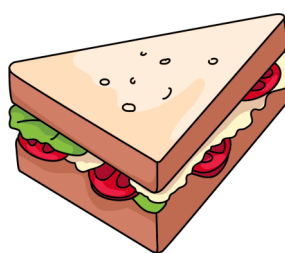
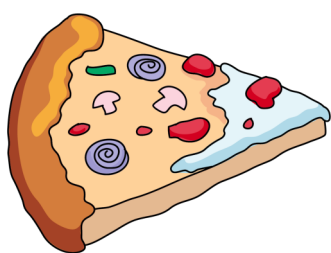

Color by Rhyme

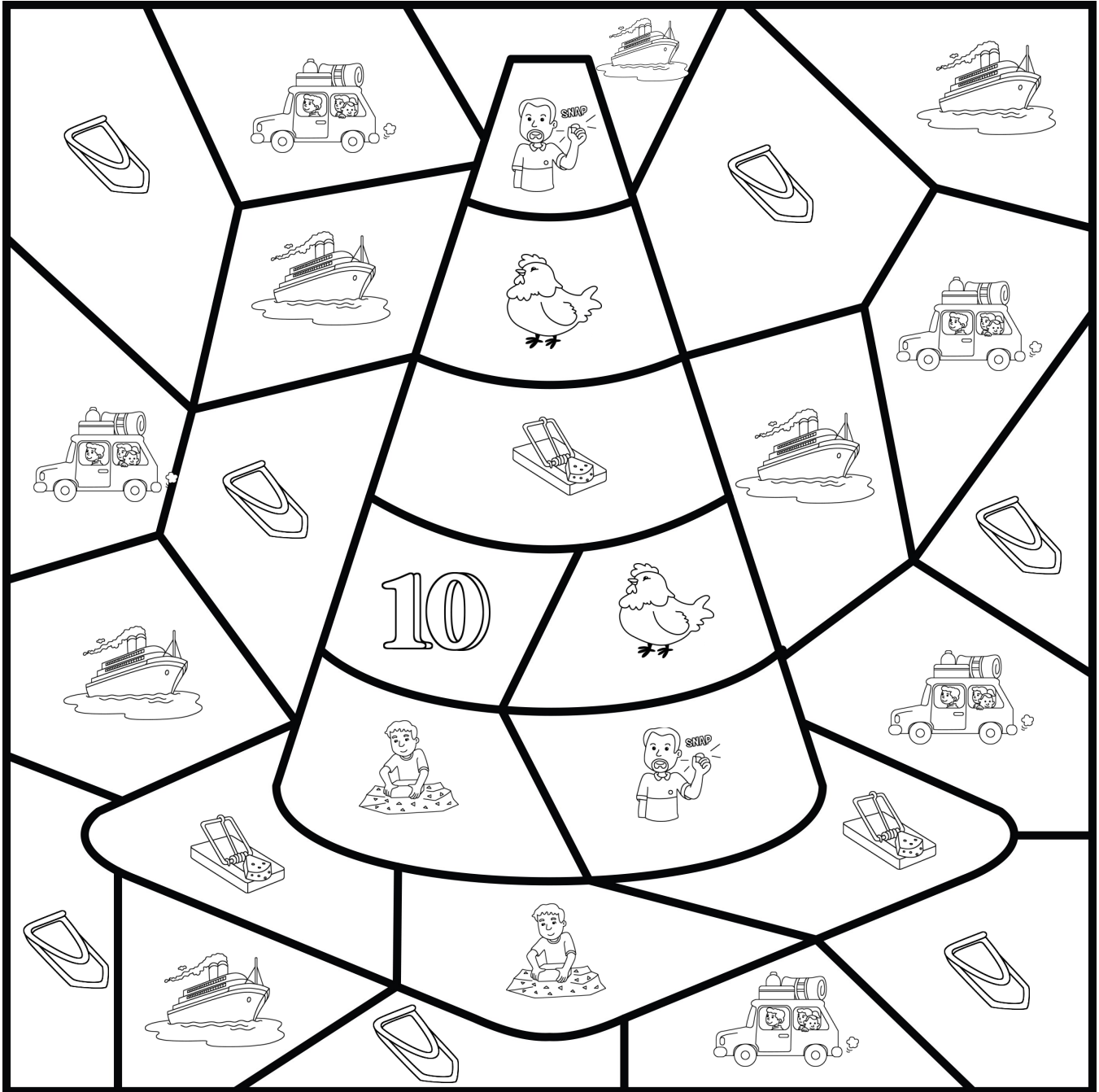

Follow the directions to color the picture.

If the word rhymes with clap  color the space orange  .

If the word rhymes with pen  color the space yellow  .

If the word rhymes with chip  color the space green  .

Color by Rhyme Key



clap



chip



snap



clip

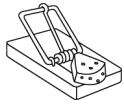

trap



ship



wrap



trip

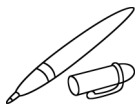

pen



ten



hen

Color by Number

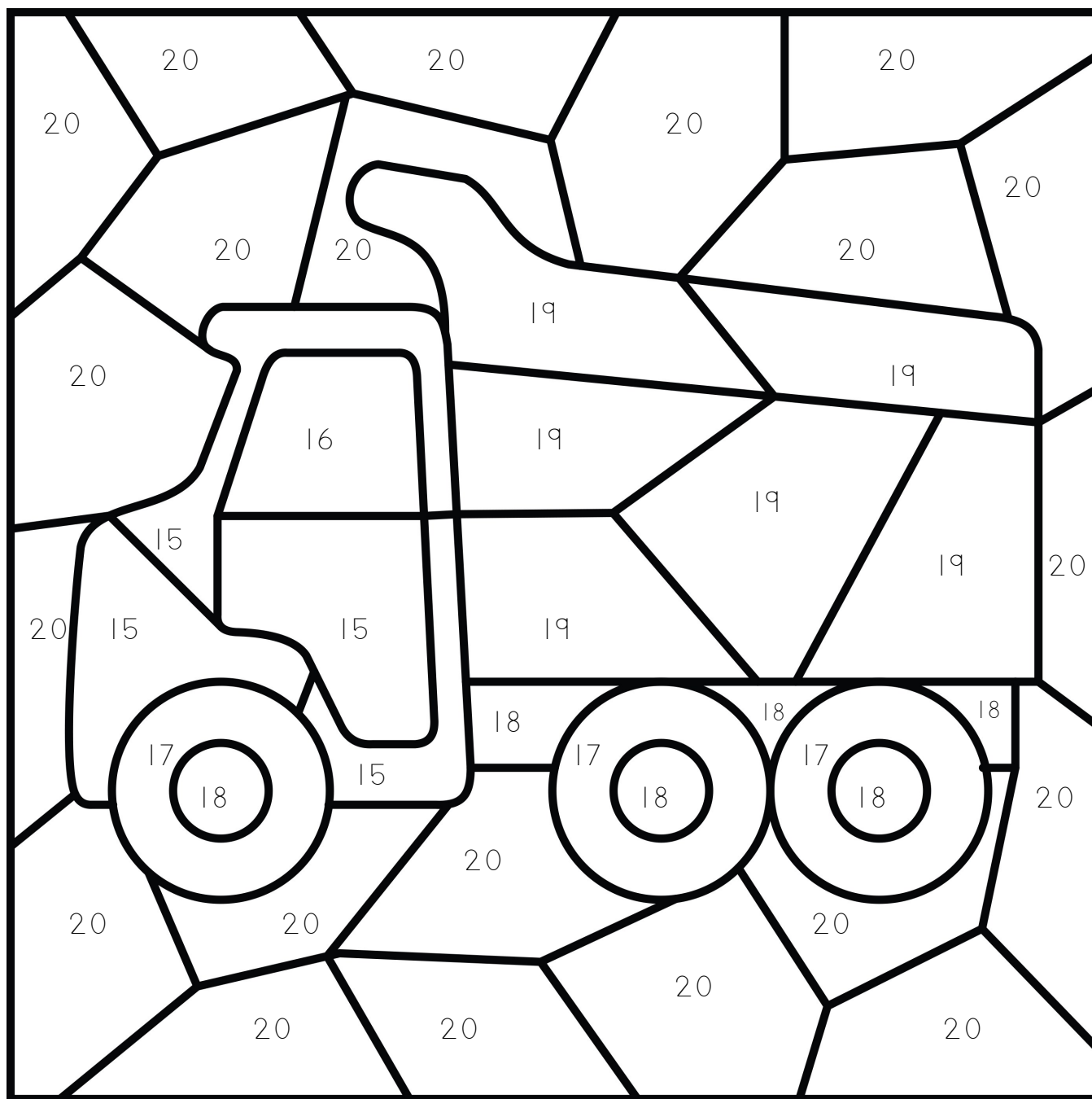

Follow the directions to color the picture.

Color the spaces with a 15 red ●.

Color the spaces with a 16 blue ●.

Color the spaces with a 17 black ●.

Color the spaces with an 18 gray ●.

Color the spaces with a 19 yellow ●.

Color the spaces with a 20 purple ●.

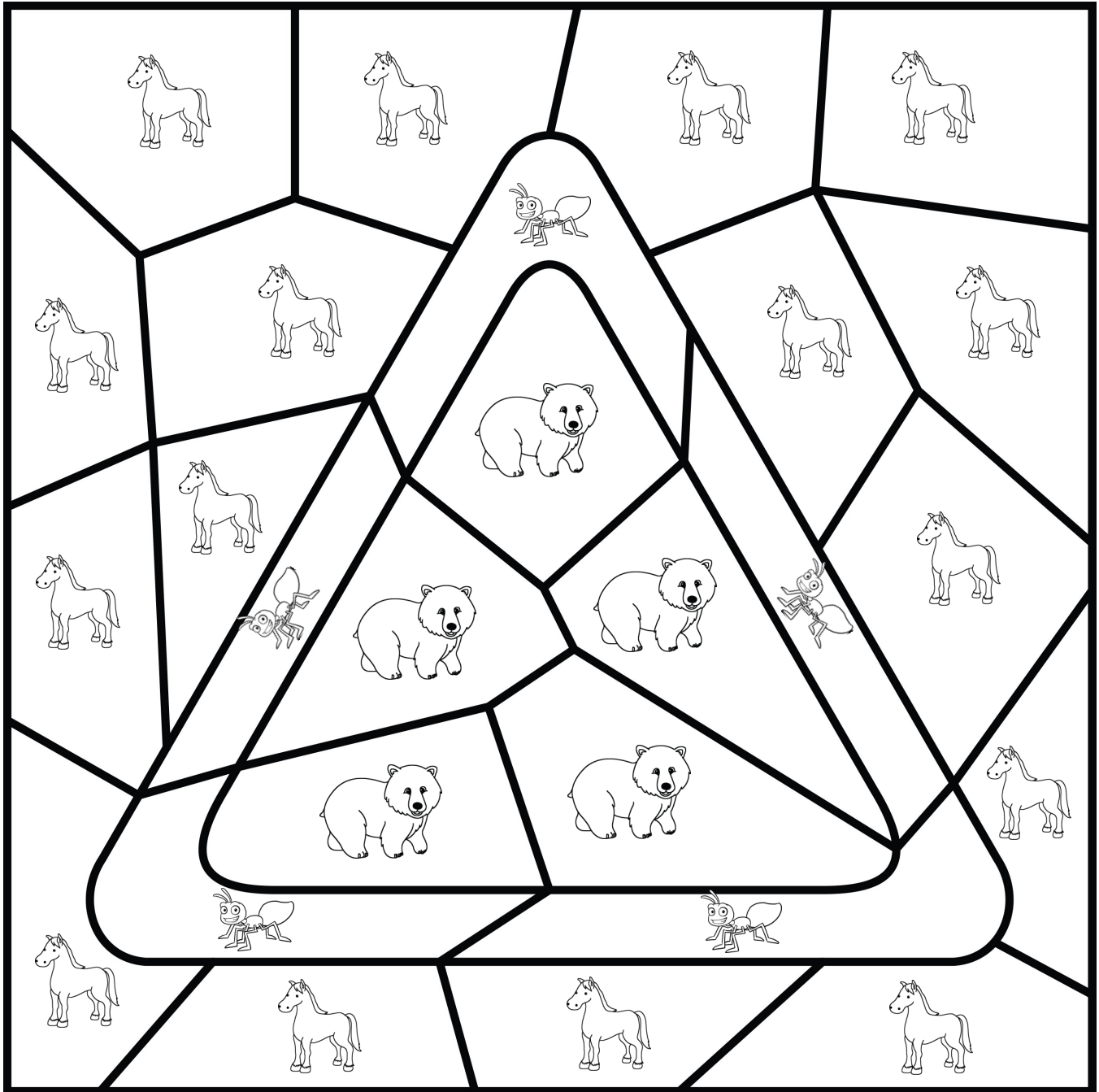

Color by Animal



Follow the directions to color the picture.

Color the spaces with an ant  red .

Color the spaces with a bear  yellow .

Color the spaces with a horse  green .

Color by Word

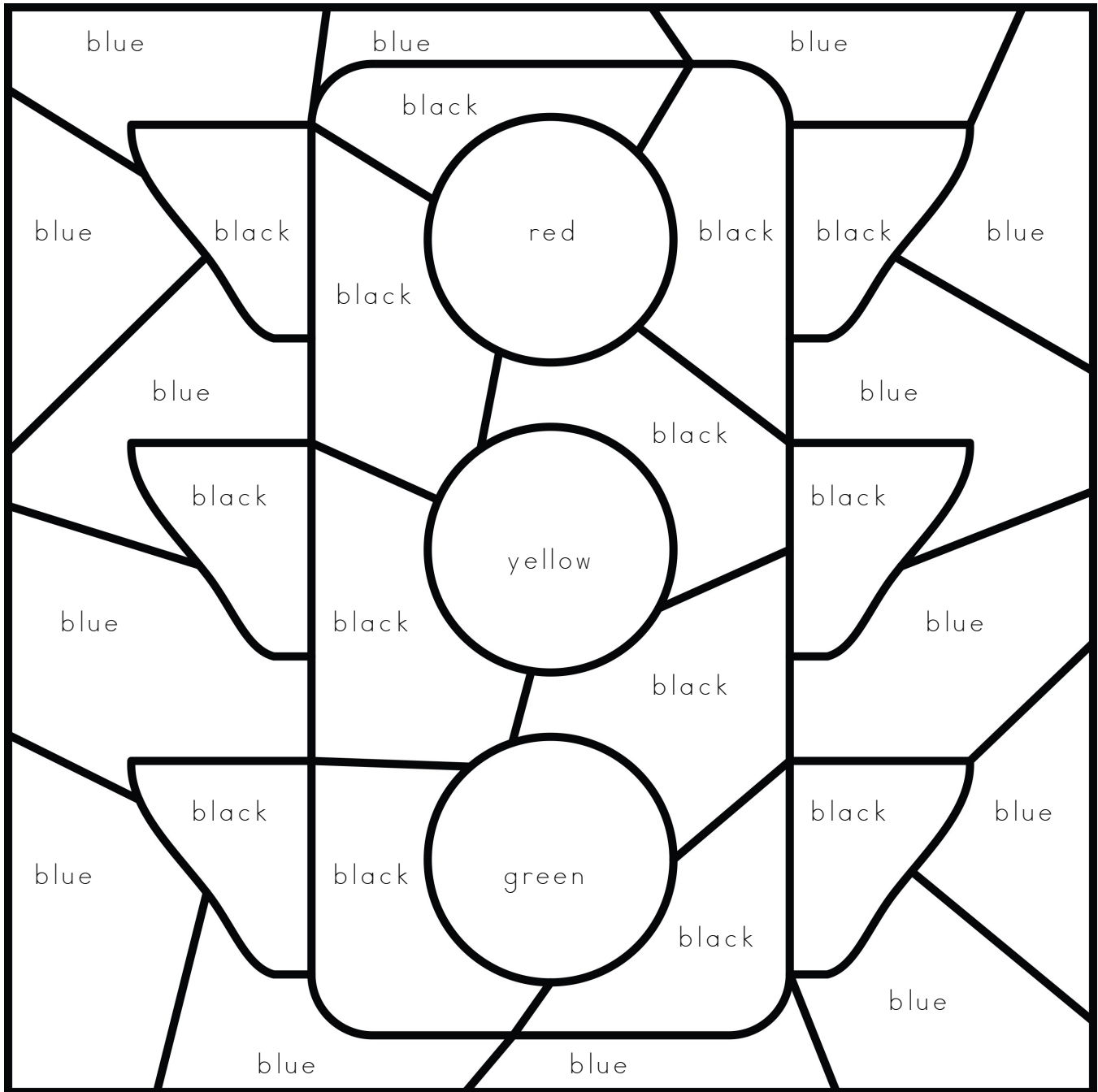

Follow the directions to color the picture.

Color the spaces with the word red, red ●.

Color the spaces with the word green, green ●.

Color the spaces with the word blue, blue ●.

Color the spaces with the word yellow, yellow ●.

Color the spaces with the word black, black ●.

Truck Tracing

Trace the lines to draw the big truck. You can color the picture if you like.

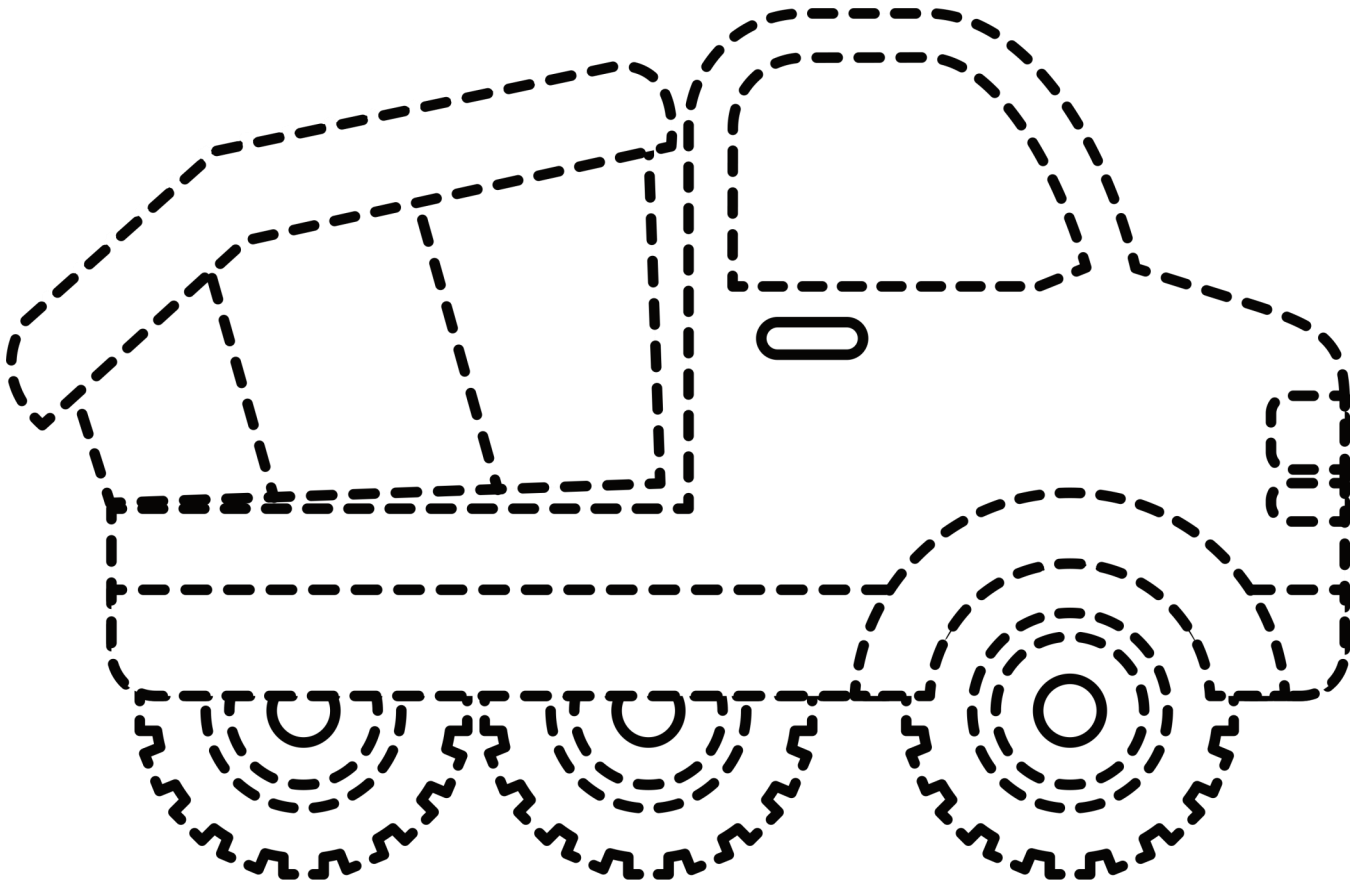

Stop Sign Tracing

Trace the lines to draw the stop sign. You can color the picture if you like.

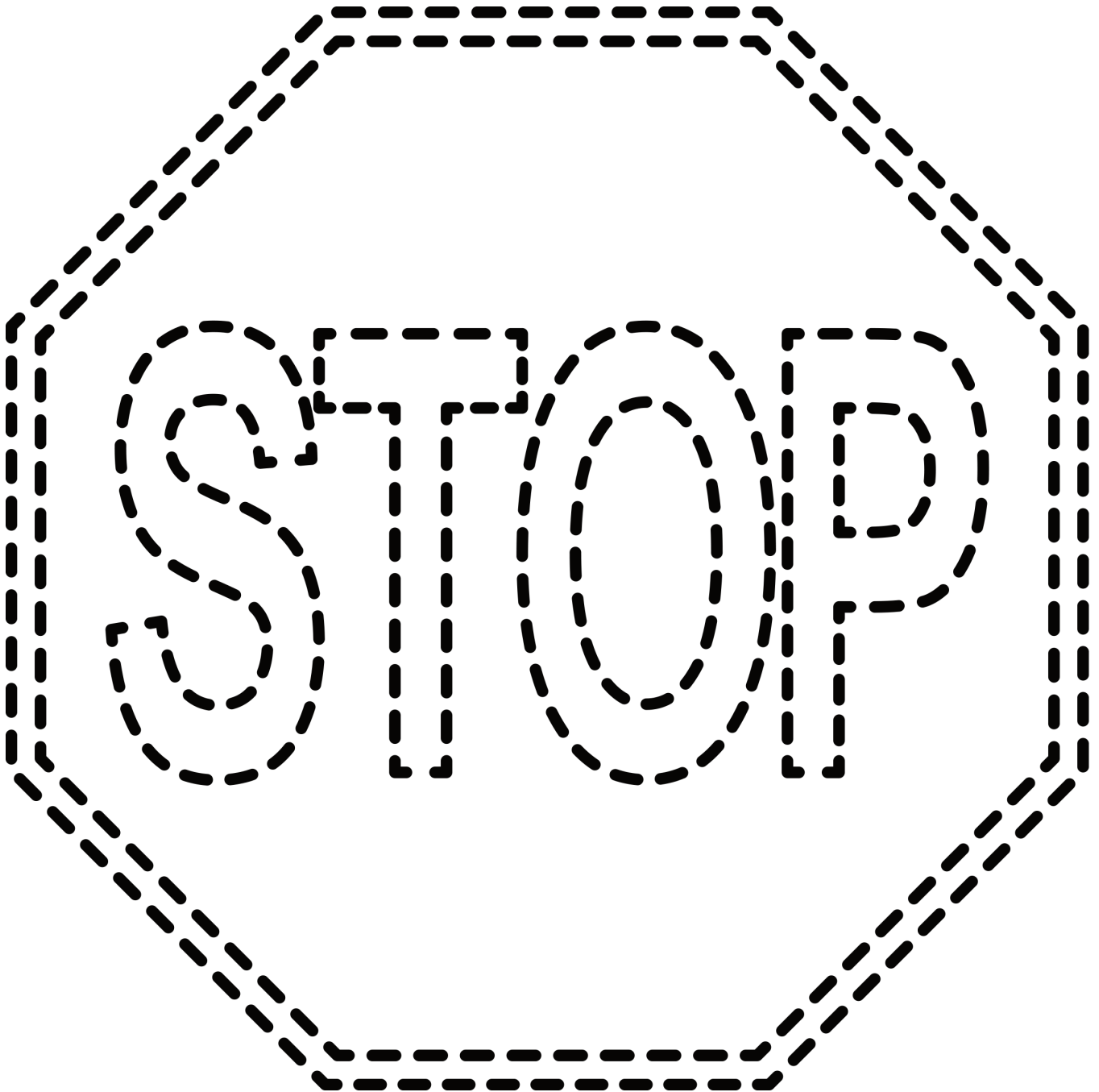

Traffic Signal Tracing

Trace the lines to draw the traffic signal. You can color the picture if you like.

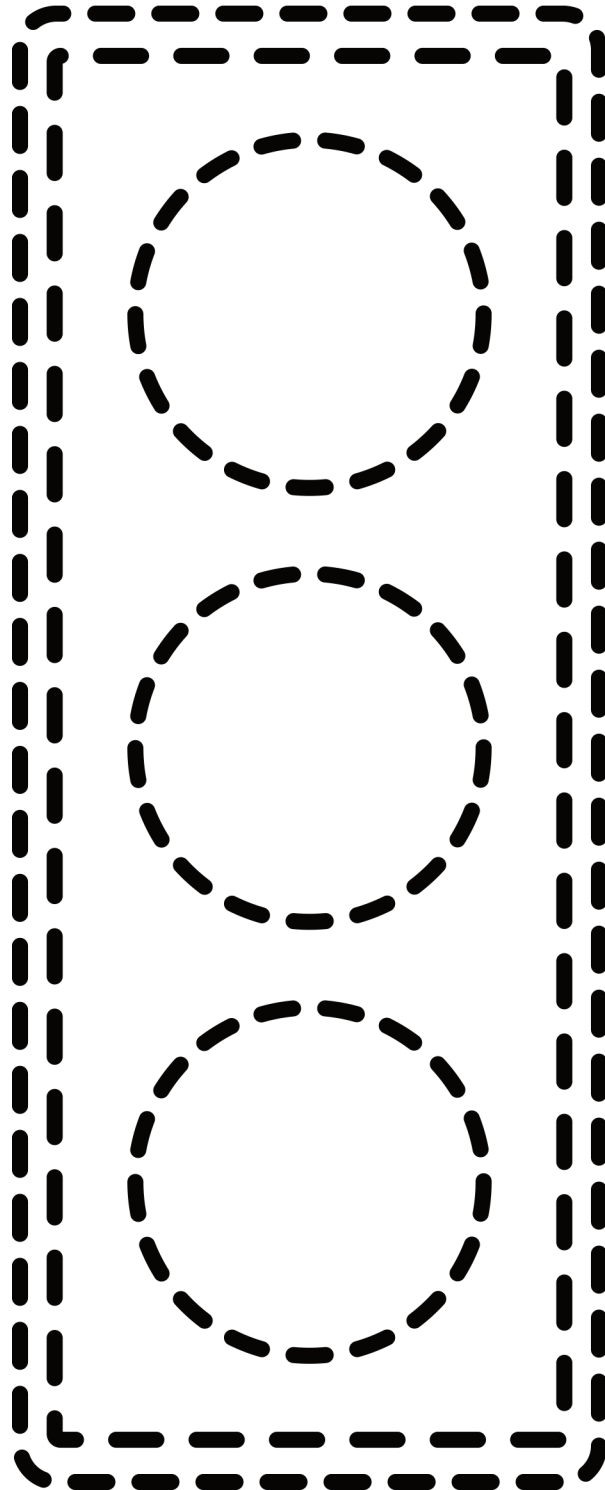

Dump Truck Tracing

Trace the lines to draw the dump truck. You can color the picture if you like.

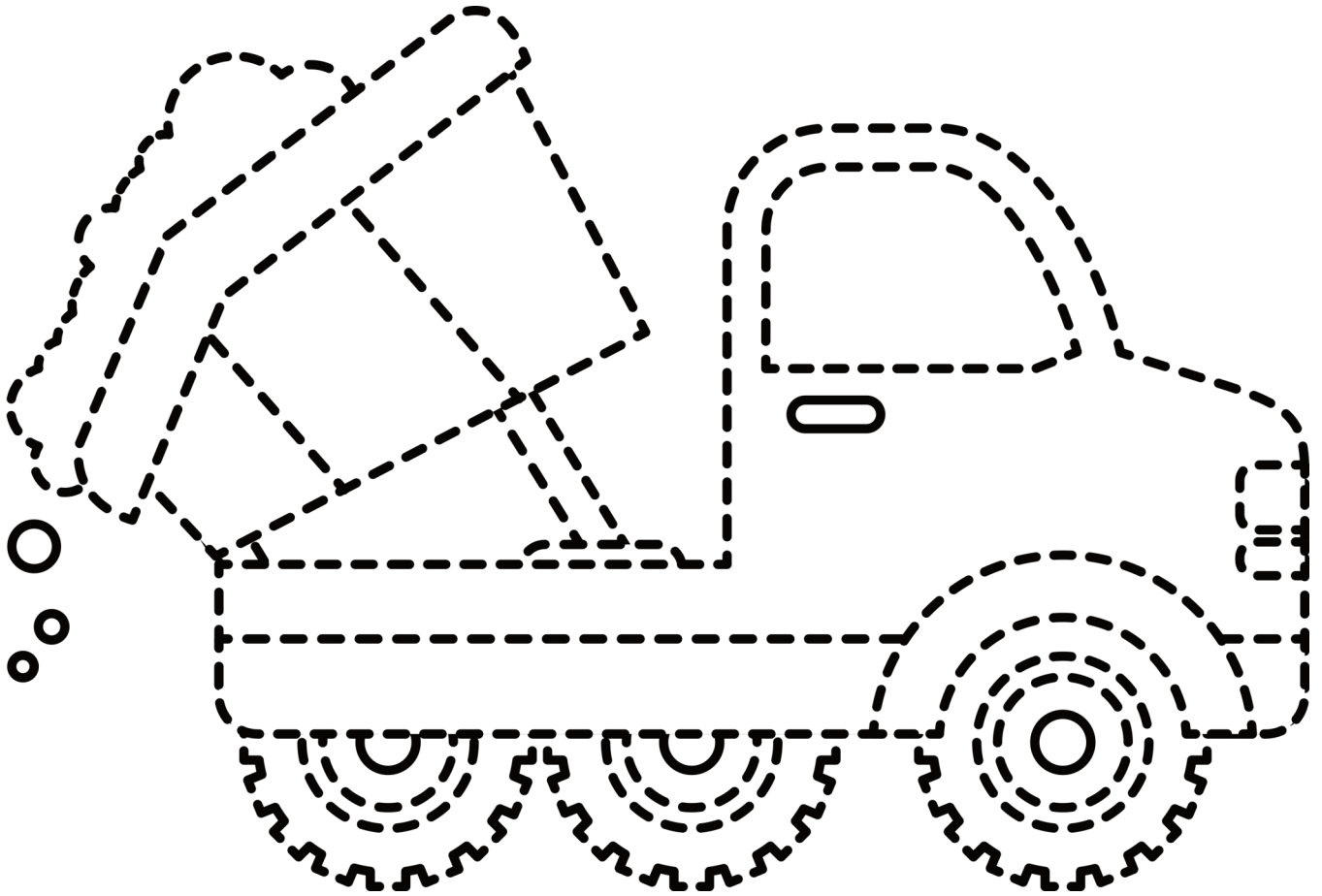

Find Your Way

Find your way through the maze by following the red dump truck.

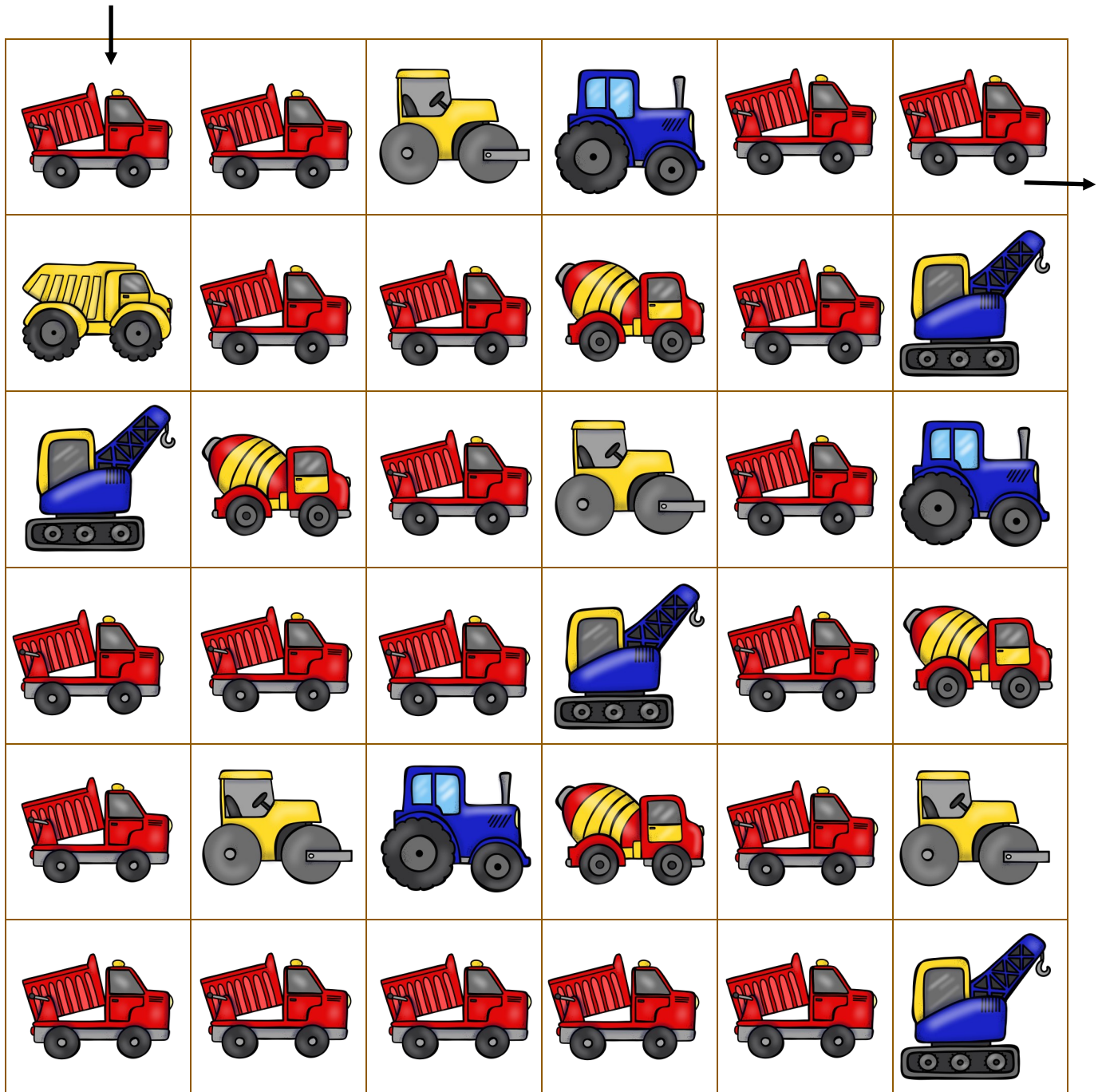

How many cement trucks  are in the maze? Write the number on the line. _____

Find Your Way to the Construction Site

Help the truck find its way to the construction site.

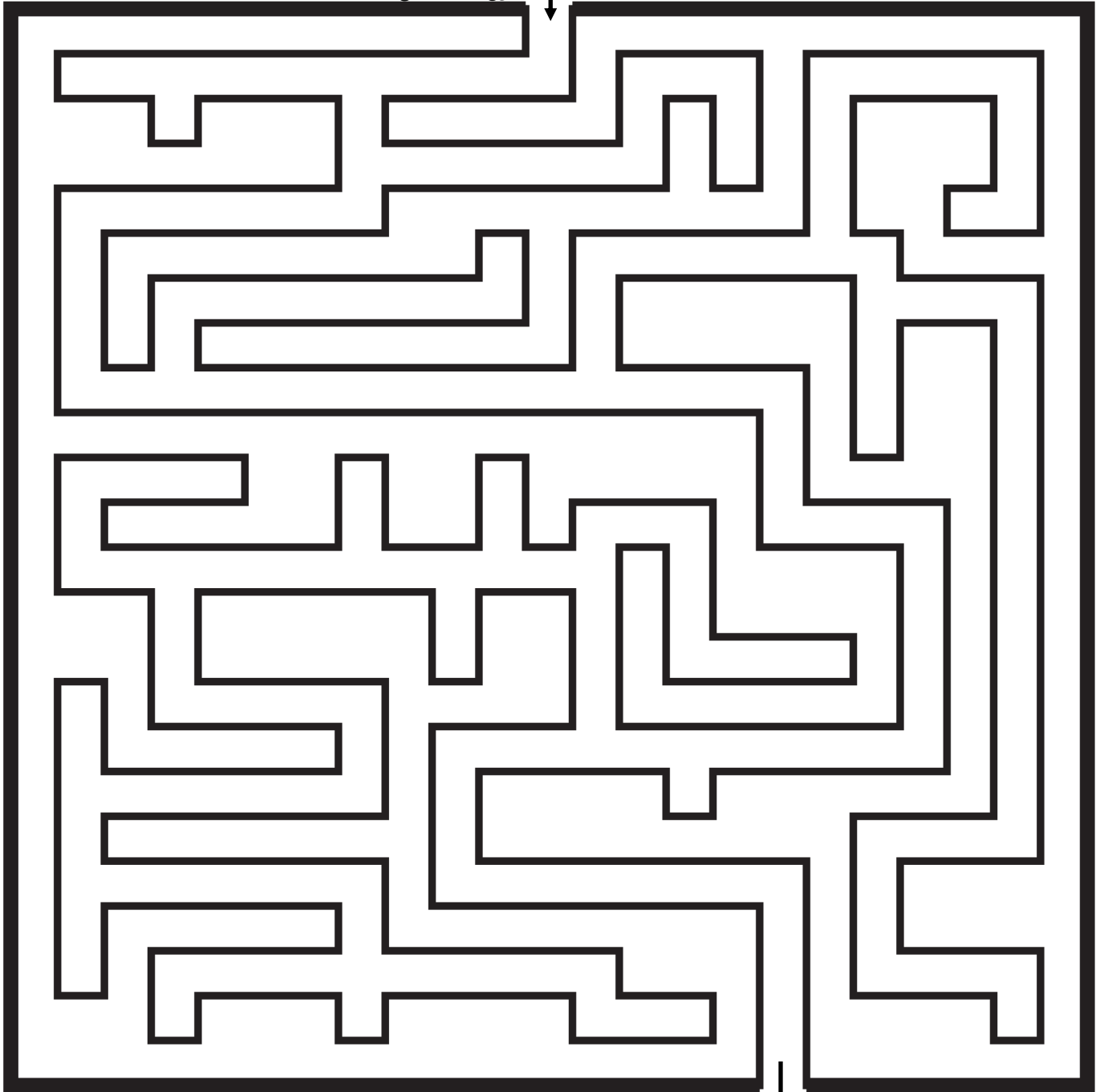

So Many Signs

Look at all the signs! Your job is to count how many of each kind of sign there is. Write the answer on the line after the question.

How many  are there? _____

How many  are there? _____

How many  are there? _____

How many  are there? _____

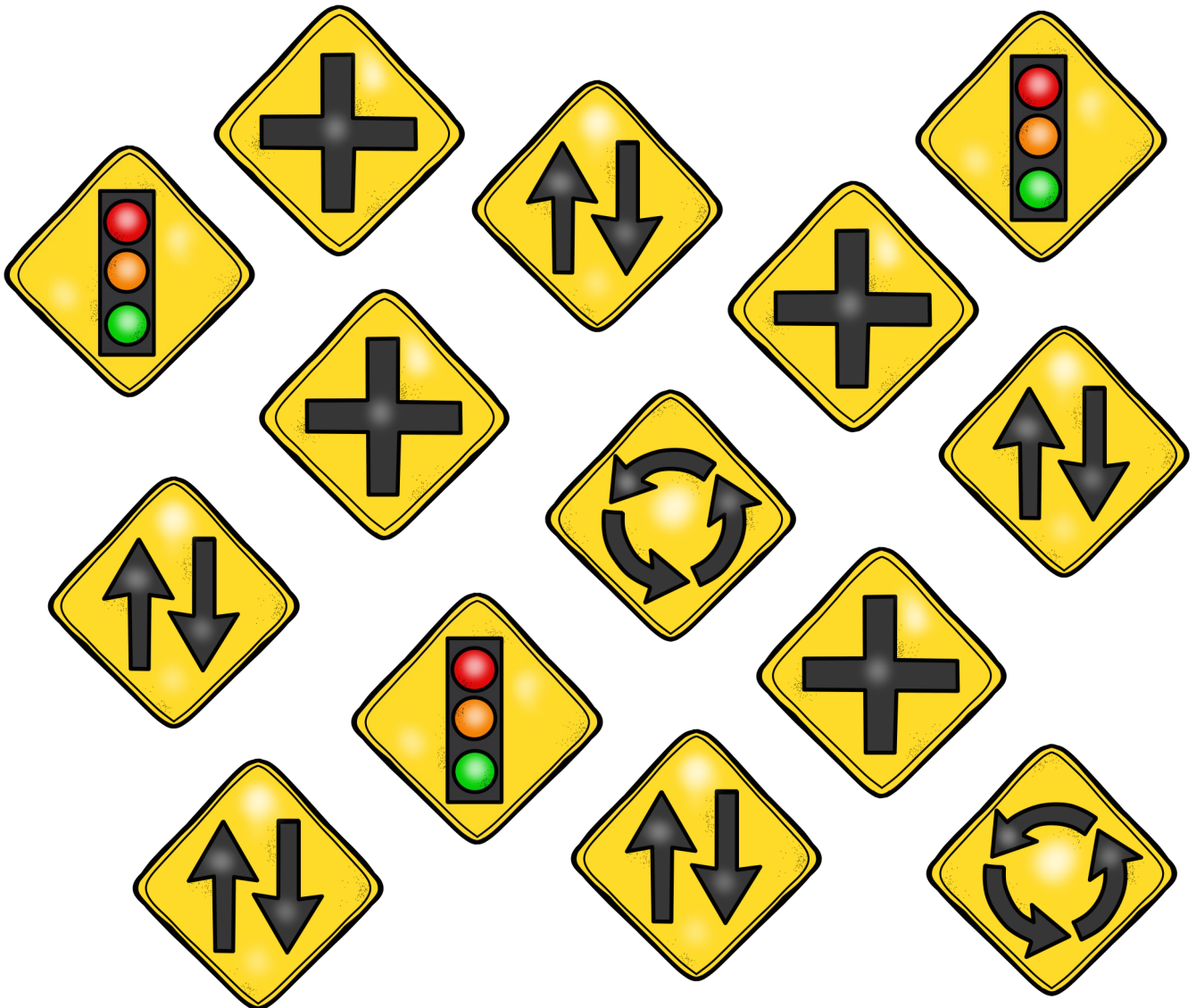

What's Missing?

These construction signs have numbers on them, but some of the numbers are missing. Write the correct number on each of the blank signs to show how to count from 1 to 10.

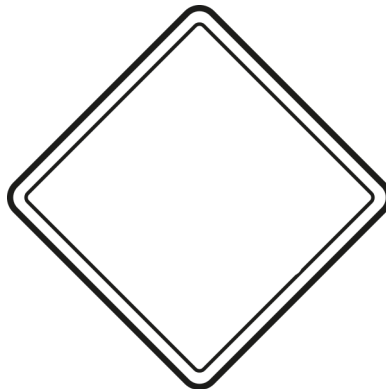
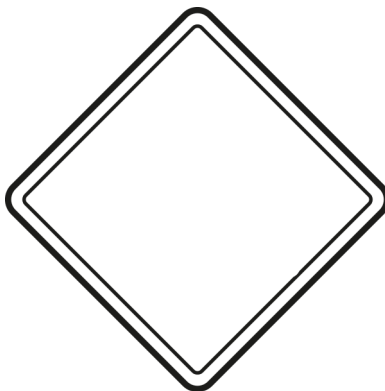
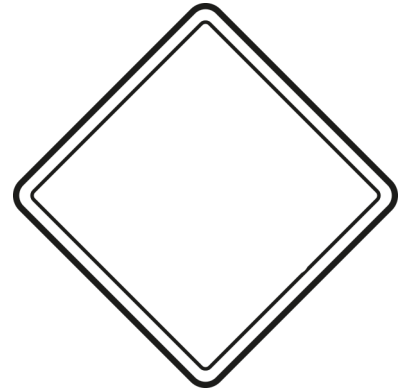
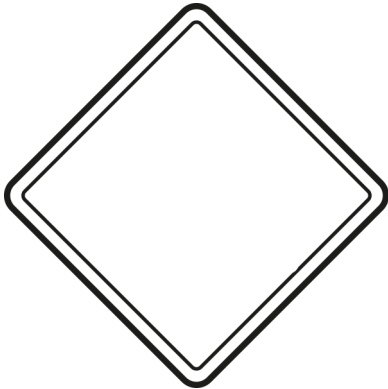
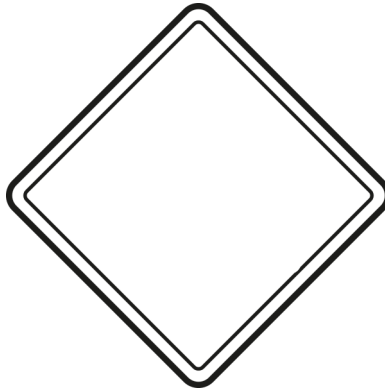

What Comes Next?

Look at each row of workers below. At the end, there is a space where the next worker is missing. Draw a circle around the worker who goes next in the row.



Which worker comes next?

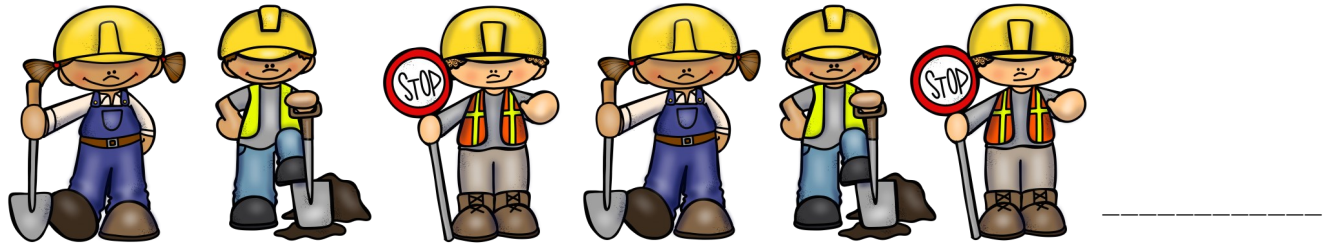

Which worker comes next?



Which worker comes next?



Follow Directions

Make a circle around the truck that is full.

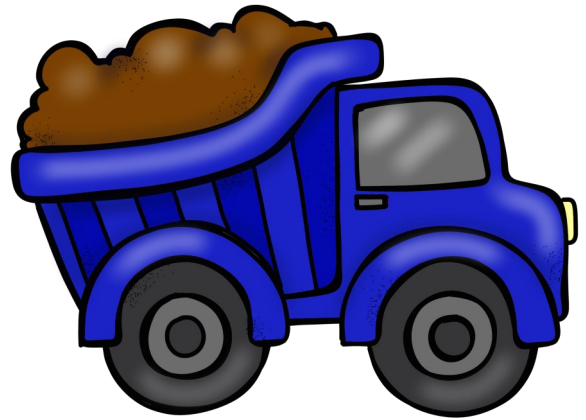

Make an X on the truck with the biggest tires.



Make a square around the truck that could fill the other one with dirt.



Color by Shape

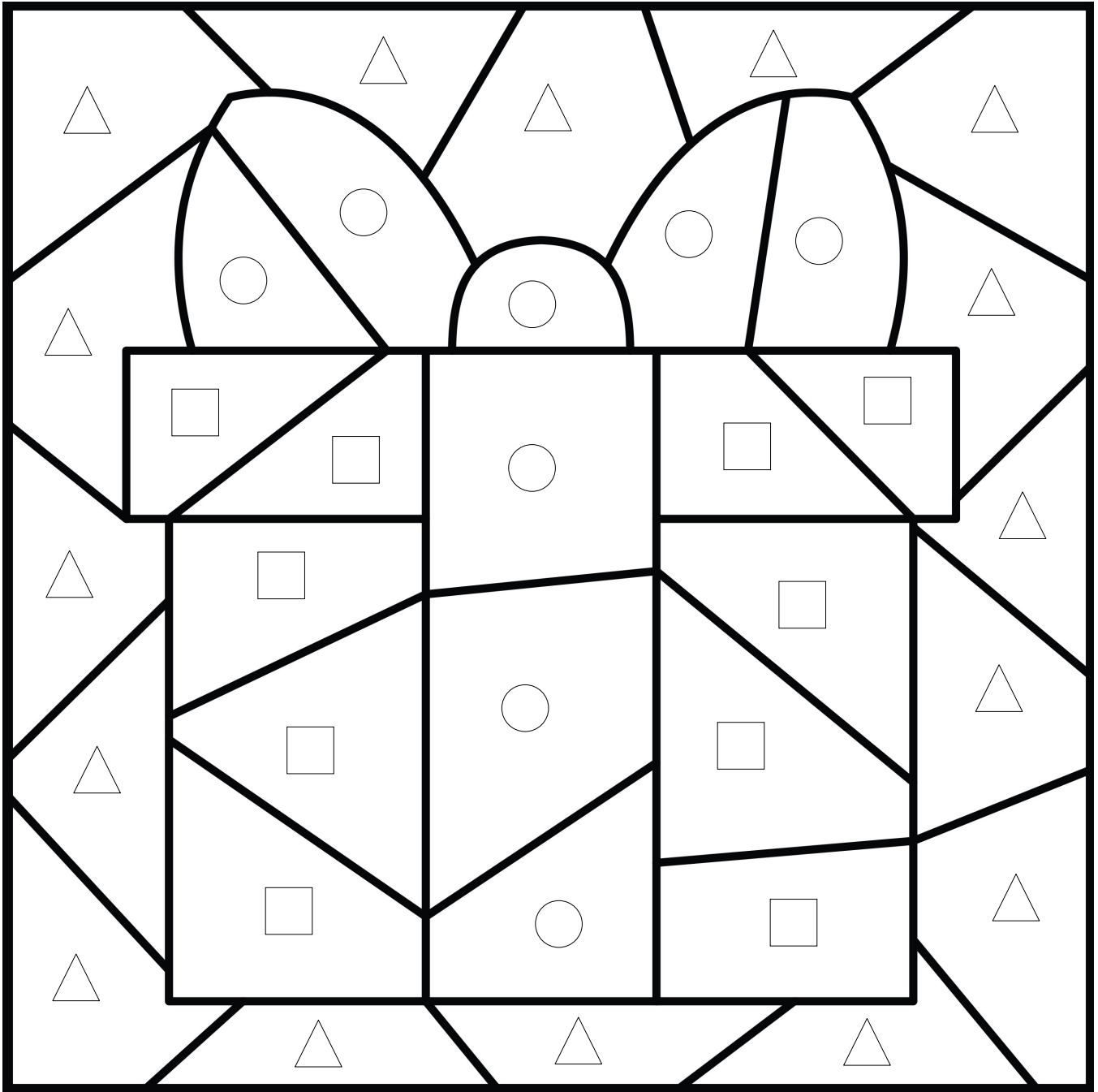

Follow the directions to color the picture.

Color the spaces with a circle  purple .

Color the spaces with a triangle  yellow .

Color the spaces with a square  orange .

Color by Number

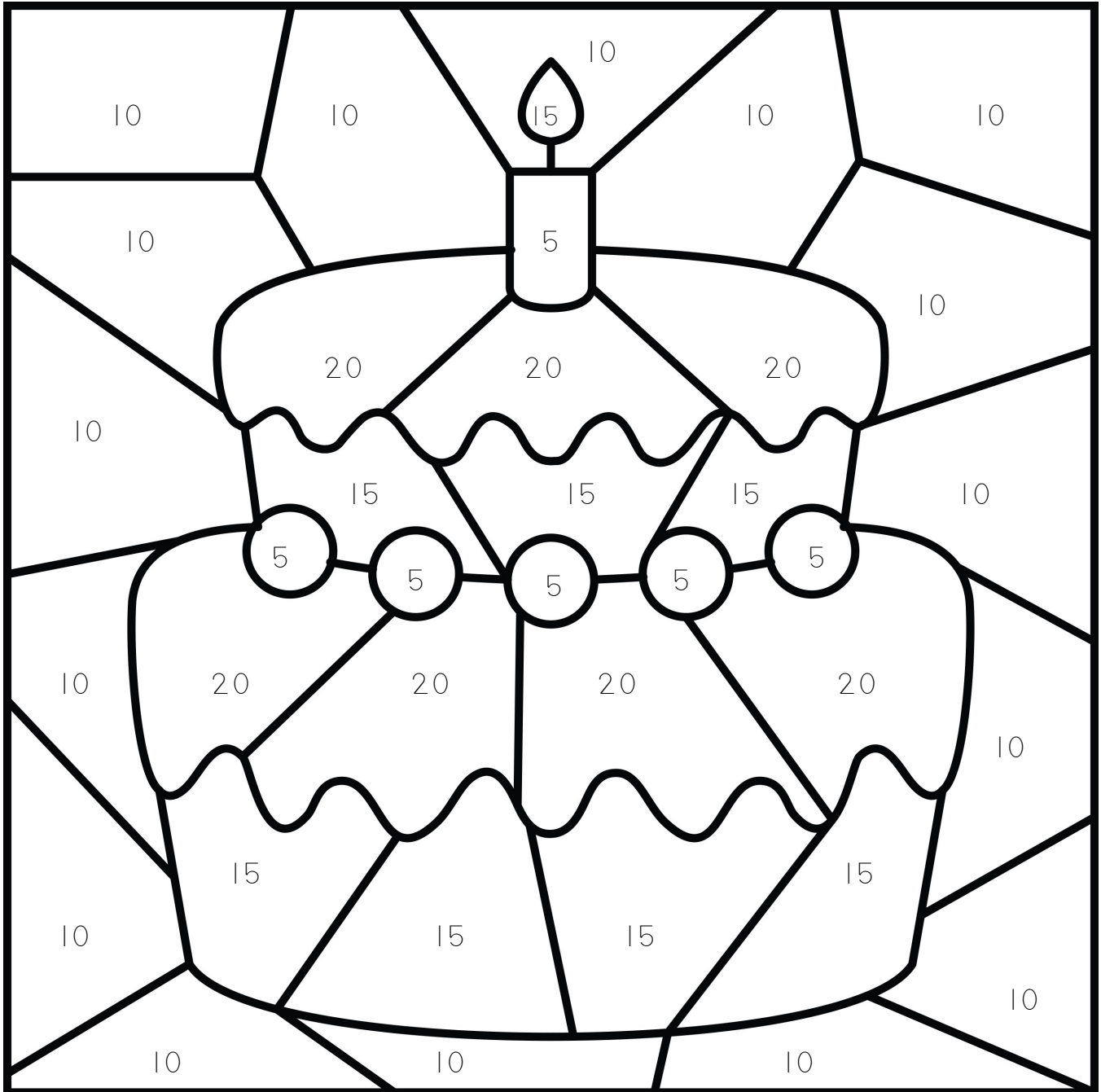

Follow the directions to color the picture.

Color the spaces with a 5 red ●.

Color the spaces with a 10 brown ●.

Color the spaces with a 15 yellow ●.

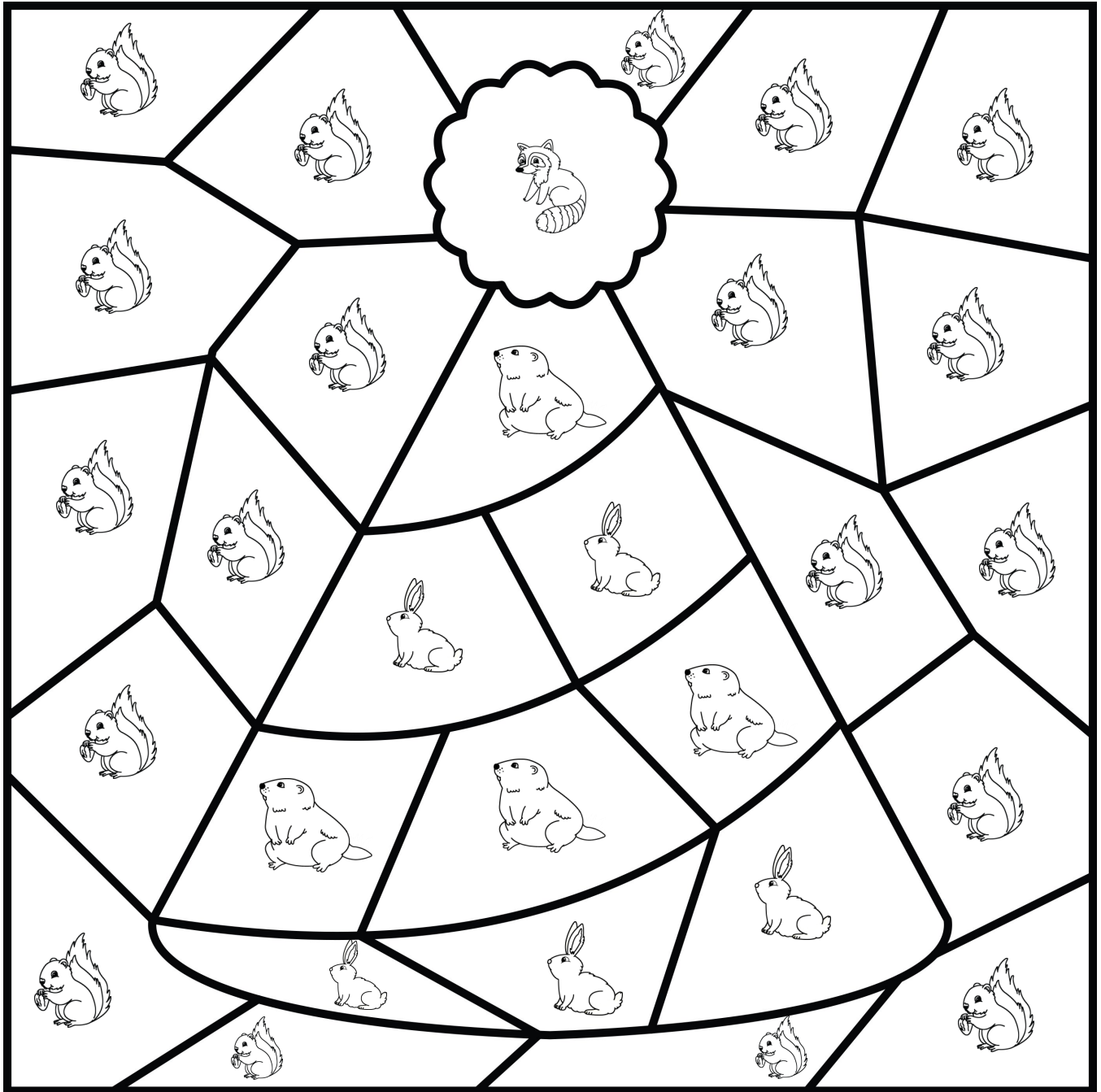

Color the spaces with a 20 pink ●.

Color by Animal



Follow the directions to color the picture.

Color the spaces with an groundhog  pink .

Color the spaces with a rabbit  purple .

Color the spaces with a squirrel  blue .

Color the spaces with a raccoon  green .

Color by Word

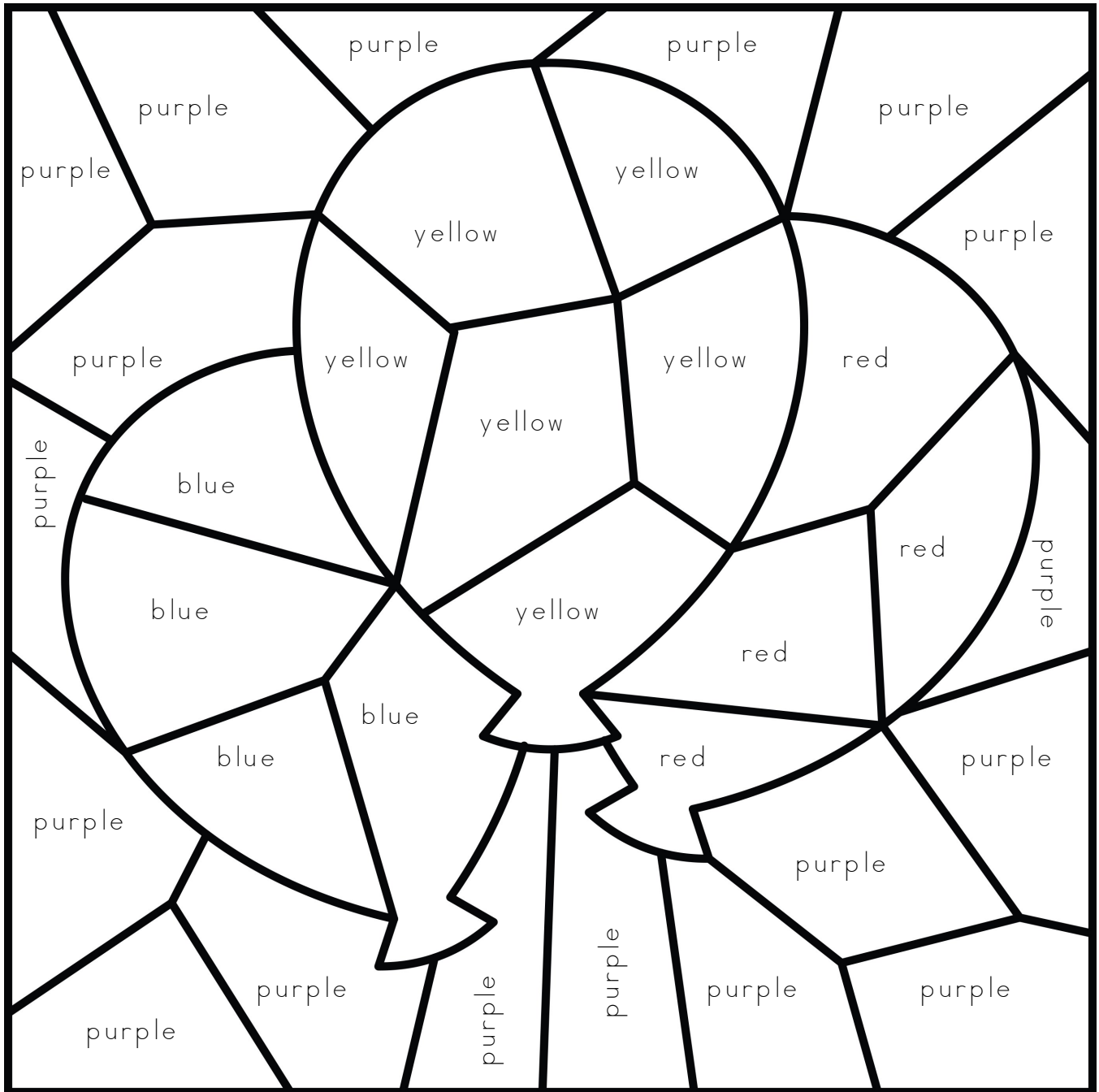

Follow the directions to color the picture.

Color the spaces with the word red, red ●.

Color the spaces with the word yellow, yellow ●.

Color the spaces with the word blue, blue ●.

Color the spaces with the word purple, purple ●.

Birthday Cake Tracing

Trace the lines to draw the birthday cake. You can color the picture if you like.

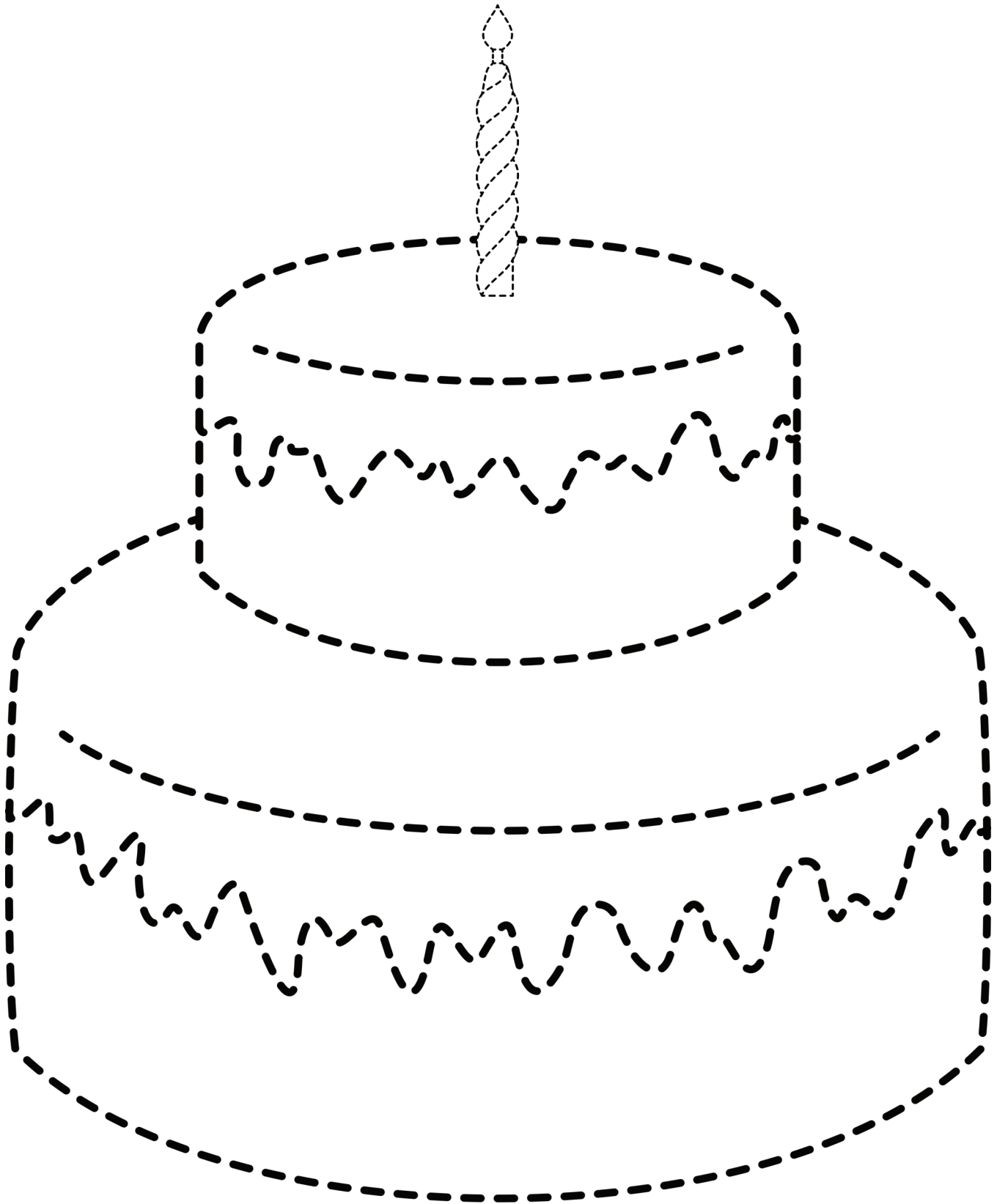

Balloons Tracing

Trace the lines to draw the balloons. You can color the picture if you like.

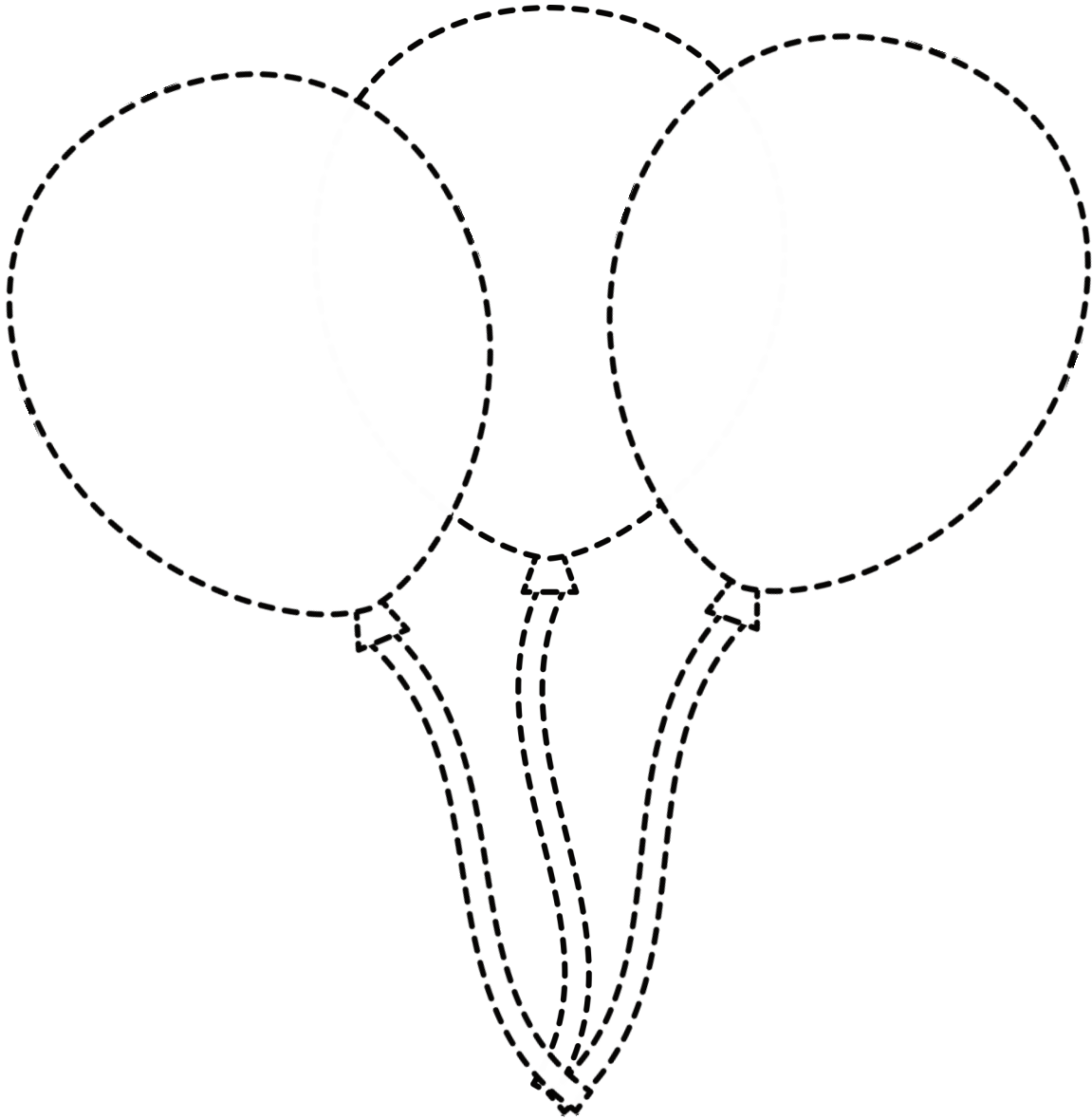

Party Hat Tracing

Trace the lines to draw the party hat. You can color the picture if you like.

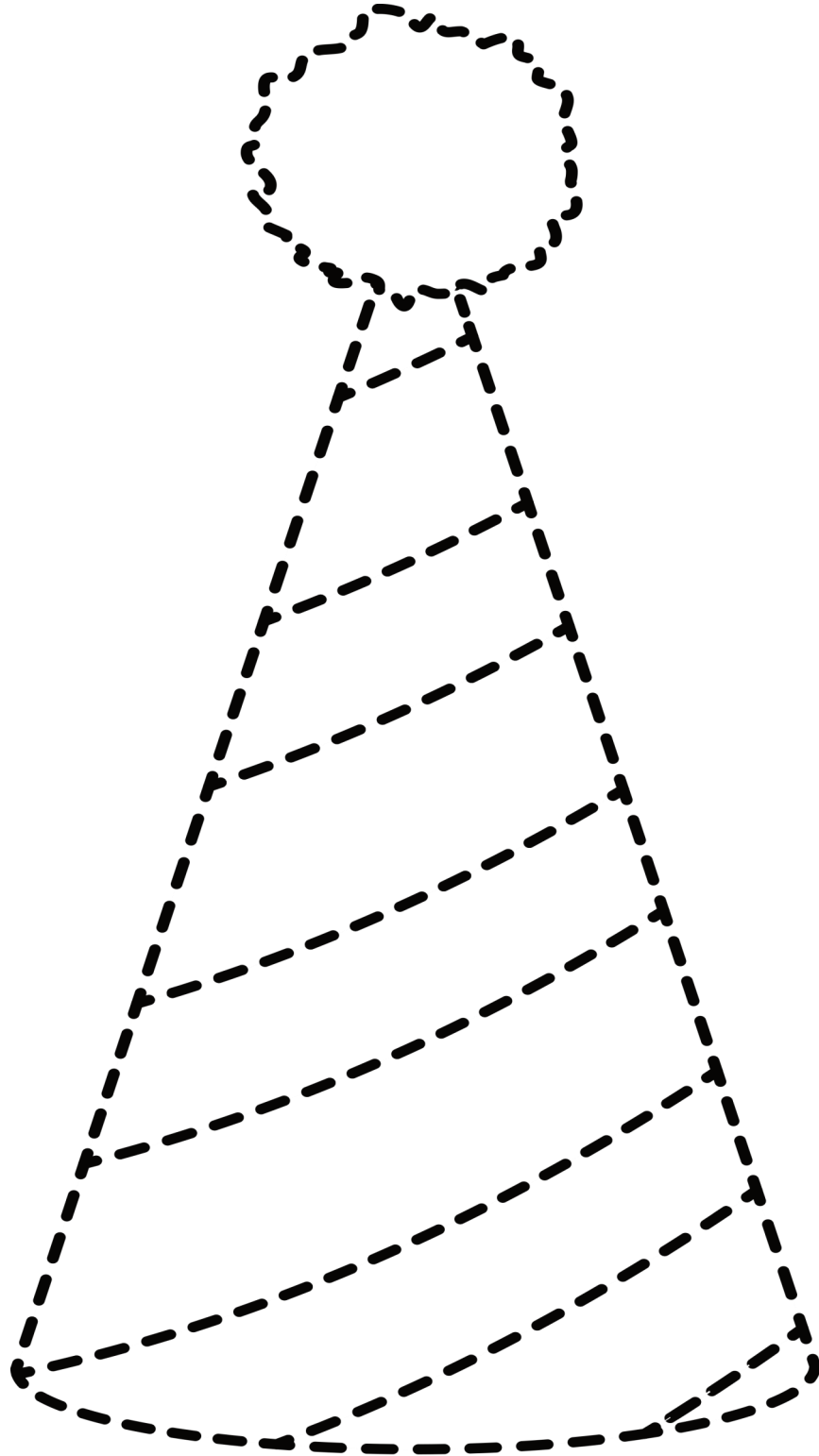

Birthday Present Tracing

Trace the lines to draw the birthday present. You can color the picture if you like.

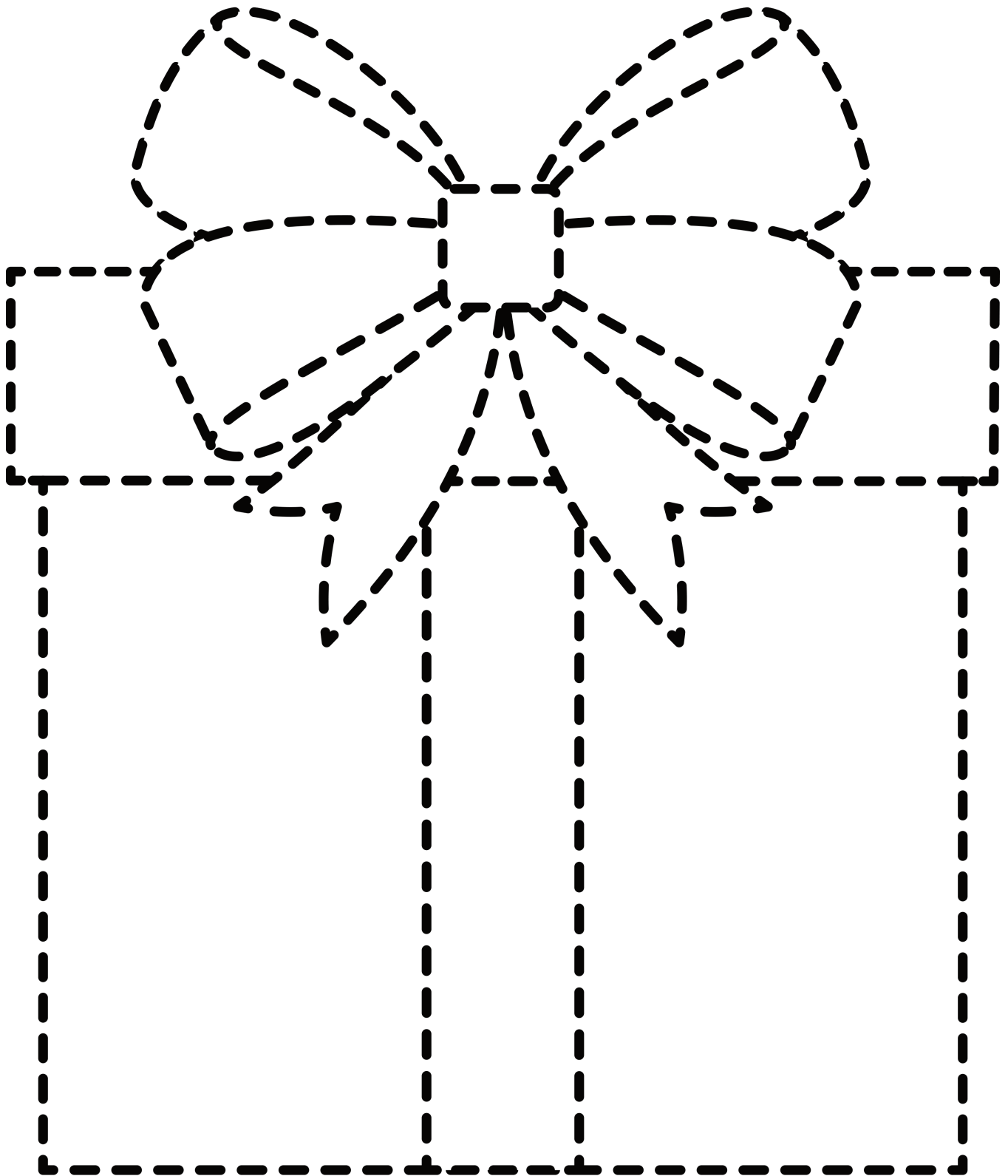

Find Your Way Lemonade

Help the lemonade pitcher fill the cup by showing it how to get to the bottom. Then someone can have a cold drink.

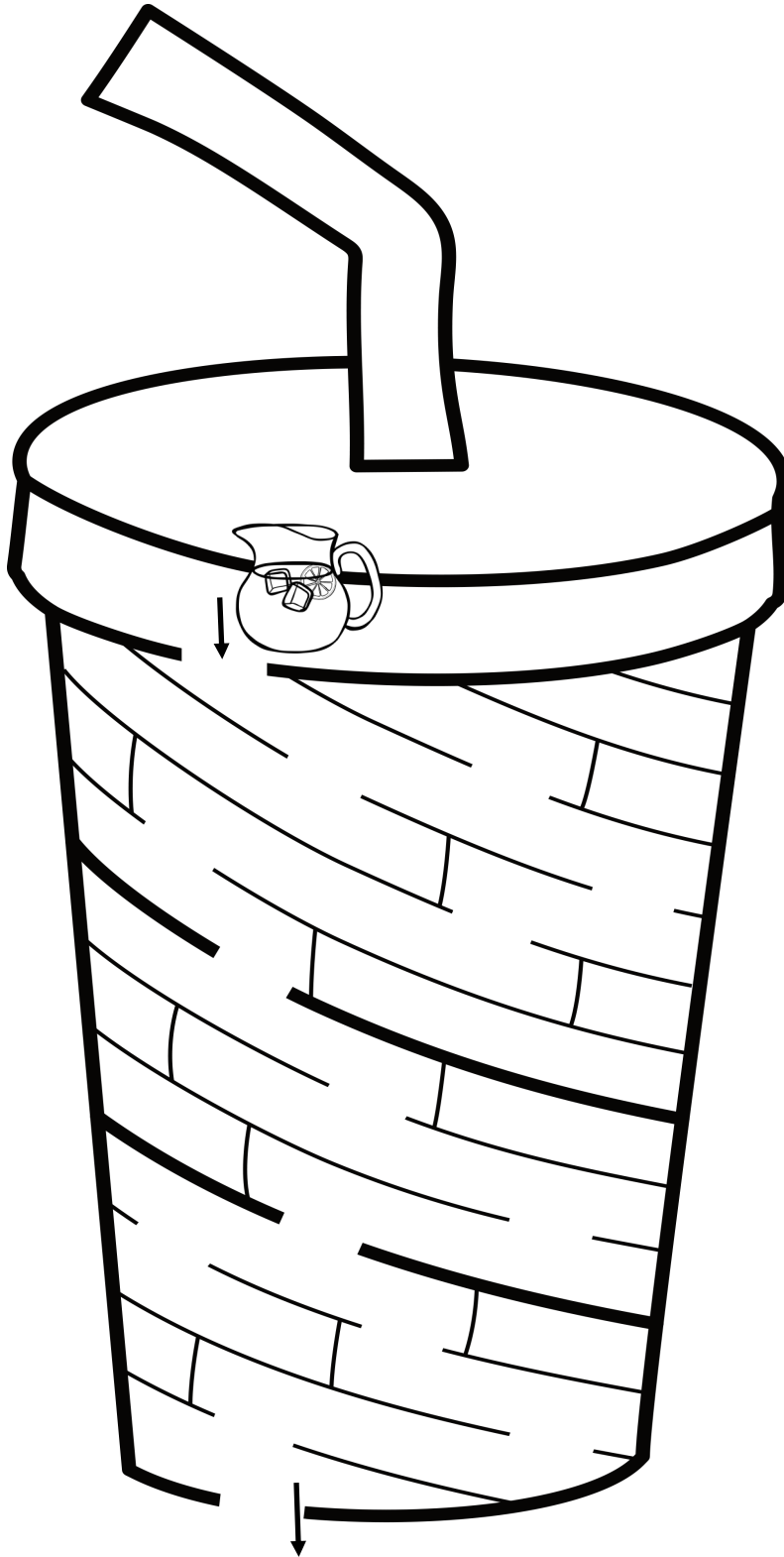

Find Your Way Popcorn

Help make sure the butter reaches all the popcorn by showing it the way through the container.

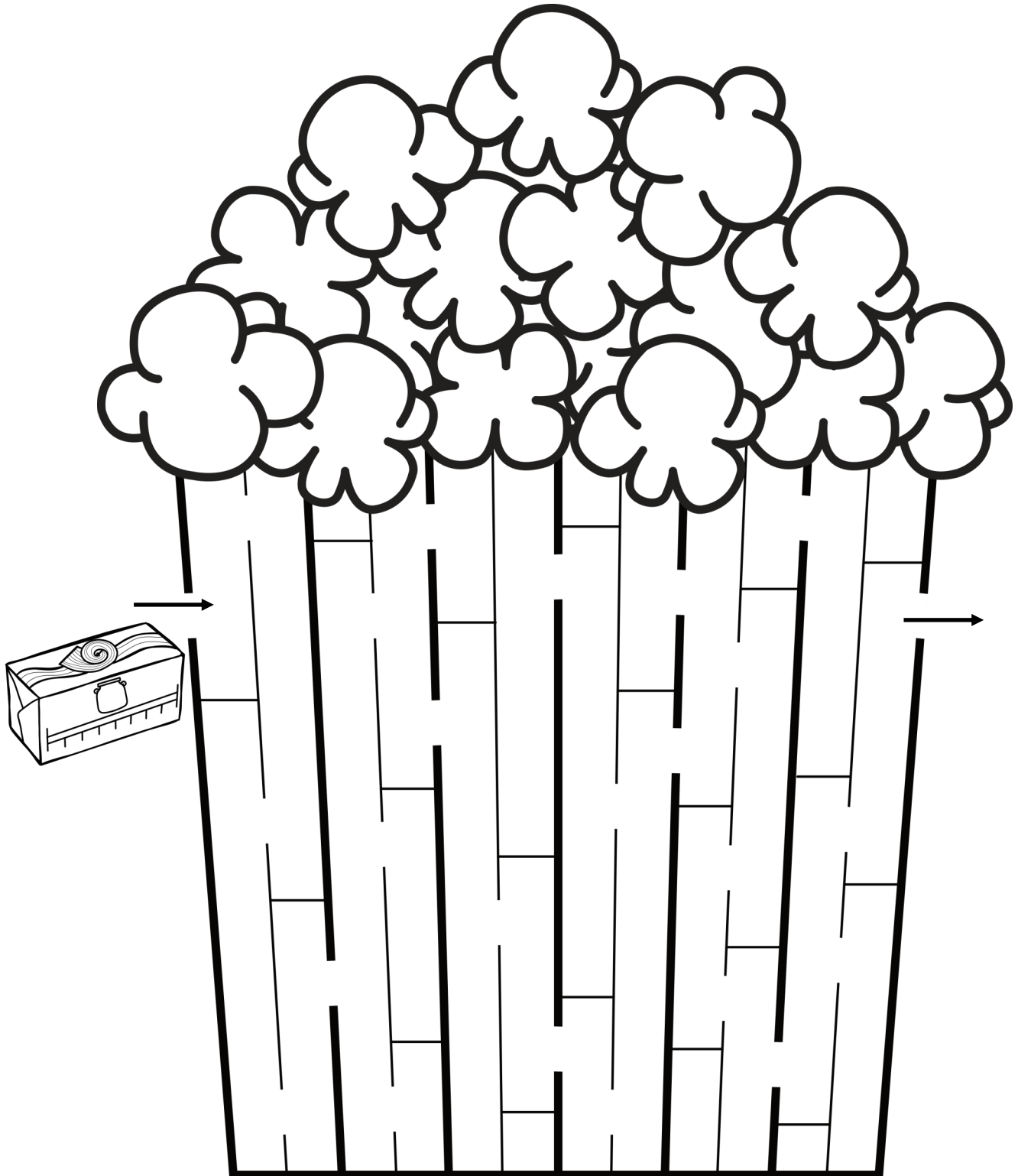

Find Your Way Hot Dog

Help the mustard find the ketchup by showing it the way through the hot dog bun.

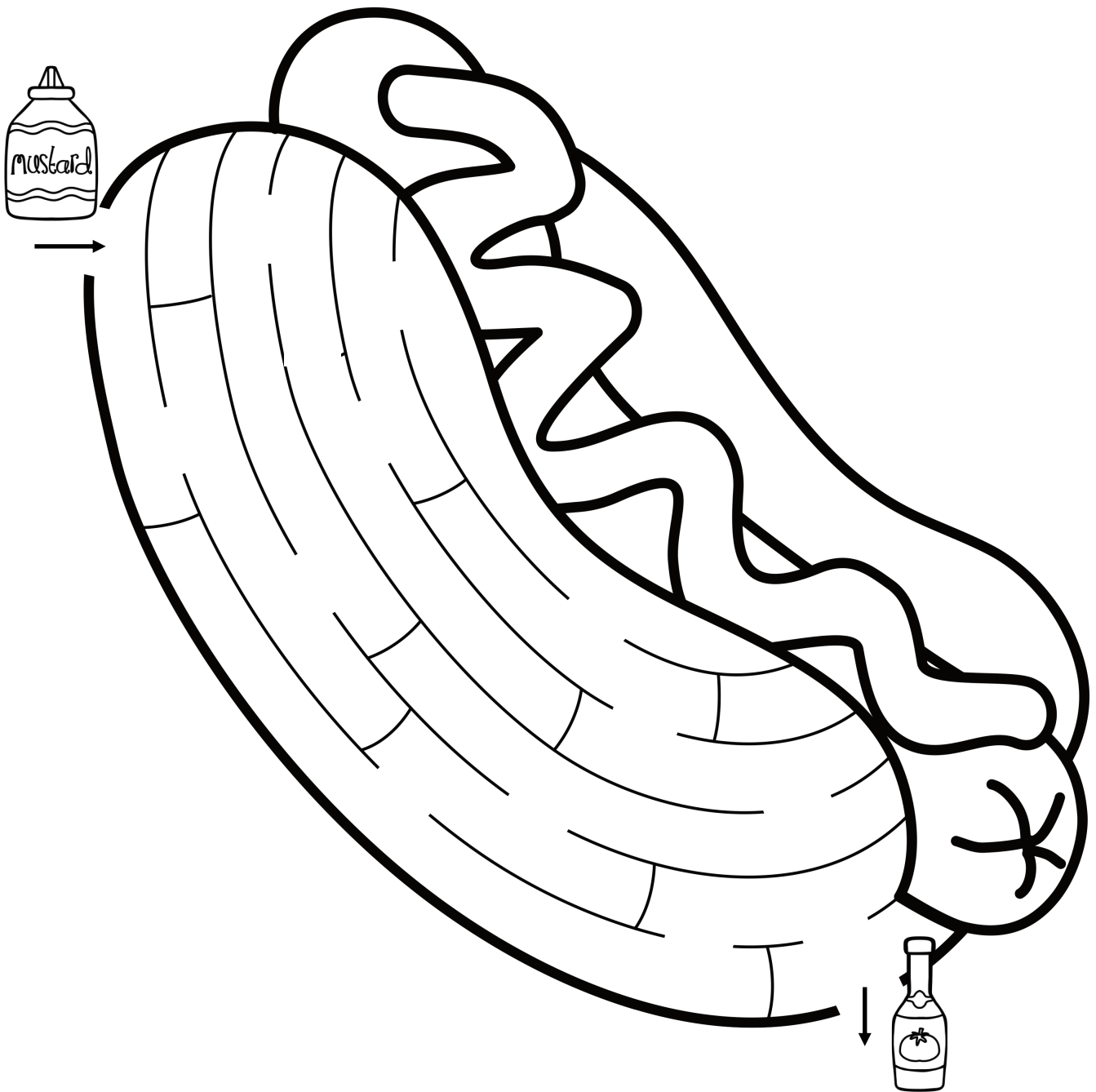

Count the Candles

Look at the birthday cakes below. Count the candles on each cake. Under each cake are three numbers. Circle the number that shows how many candles are on the cake.

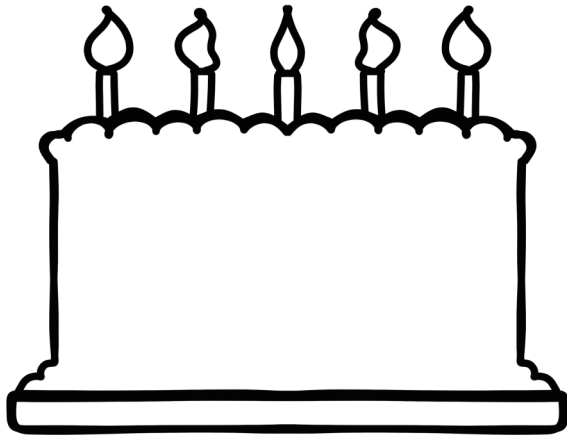

6 5 2

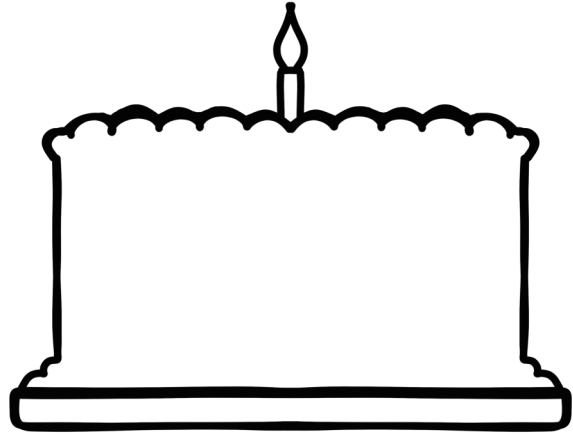

3 4 1

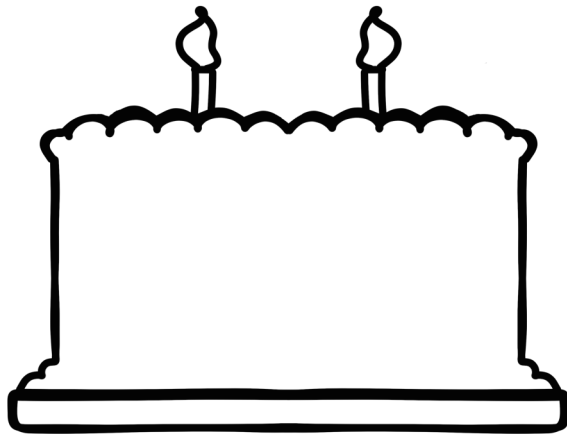

2 4 3

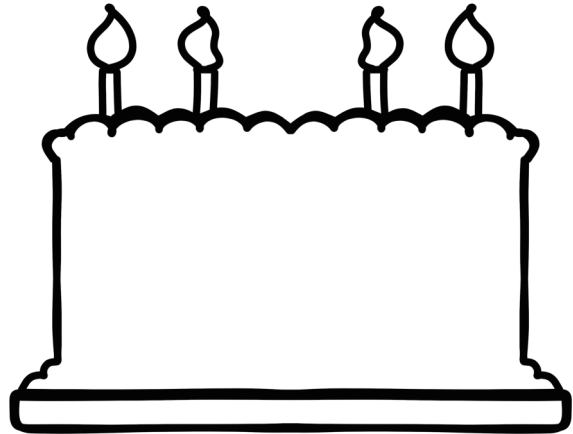

6 4 2

Baking a Cake

The boy in the picture is helping at home by baking a cake. His mom got out the ingredients and told him how much to put in. When the cake was done, he decorated it, and mom cut a piece of cake for both of them. Put a number in the box below each picture to show how he would start baking the cake (1) to where the boy and his mom are ready to eat their cake (4).



What Comes Next?

Look at each row of birthday gifts below. At the end, there is a space where the next gift is missing. Draw a circle around the birthday gift that goes next in the row.

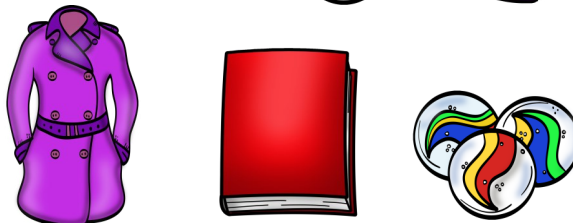
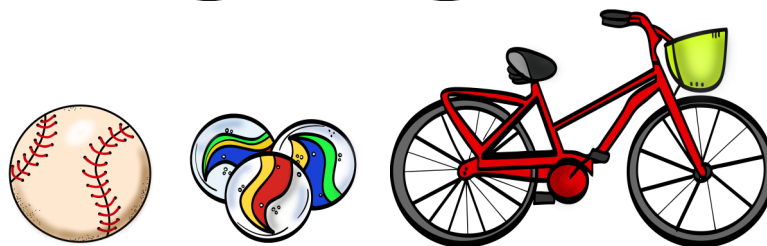
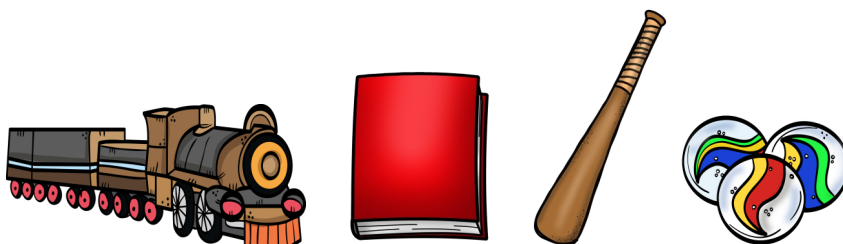

Come to the Party

Draw faces on the friends who came to the birthday party.



Color by Shape

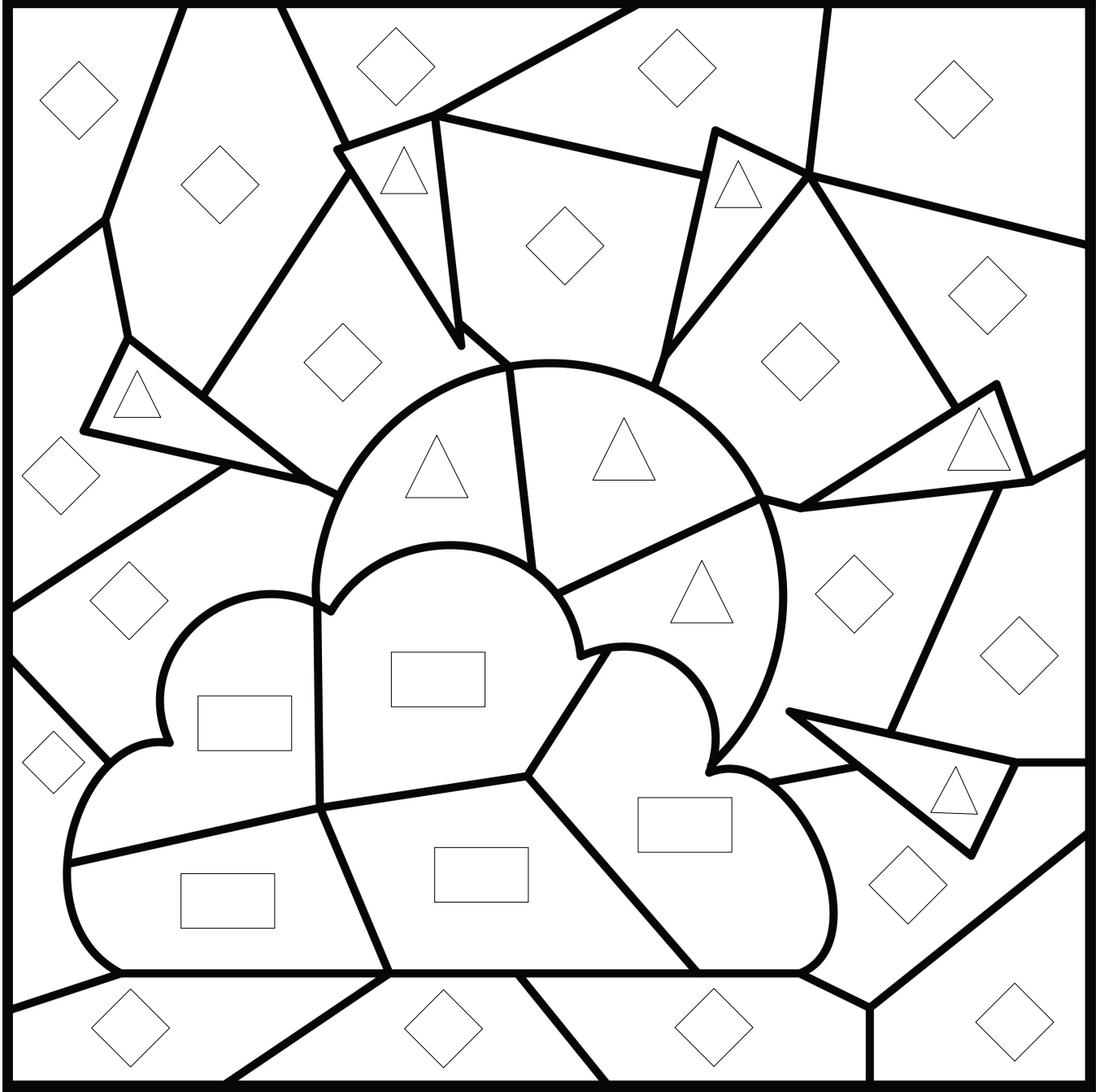

Follow the directions to color the picture.

Color the spaces with a diamond  blue .

Color the spaces with a triangle  yellow .

Color the spaces with a rectangle  gray .

Color by Number

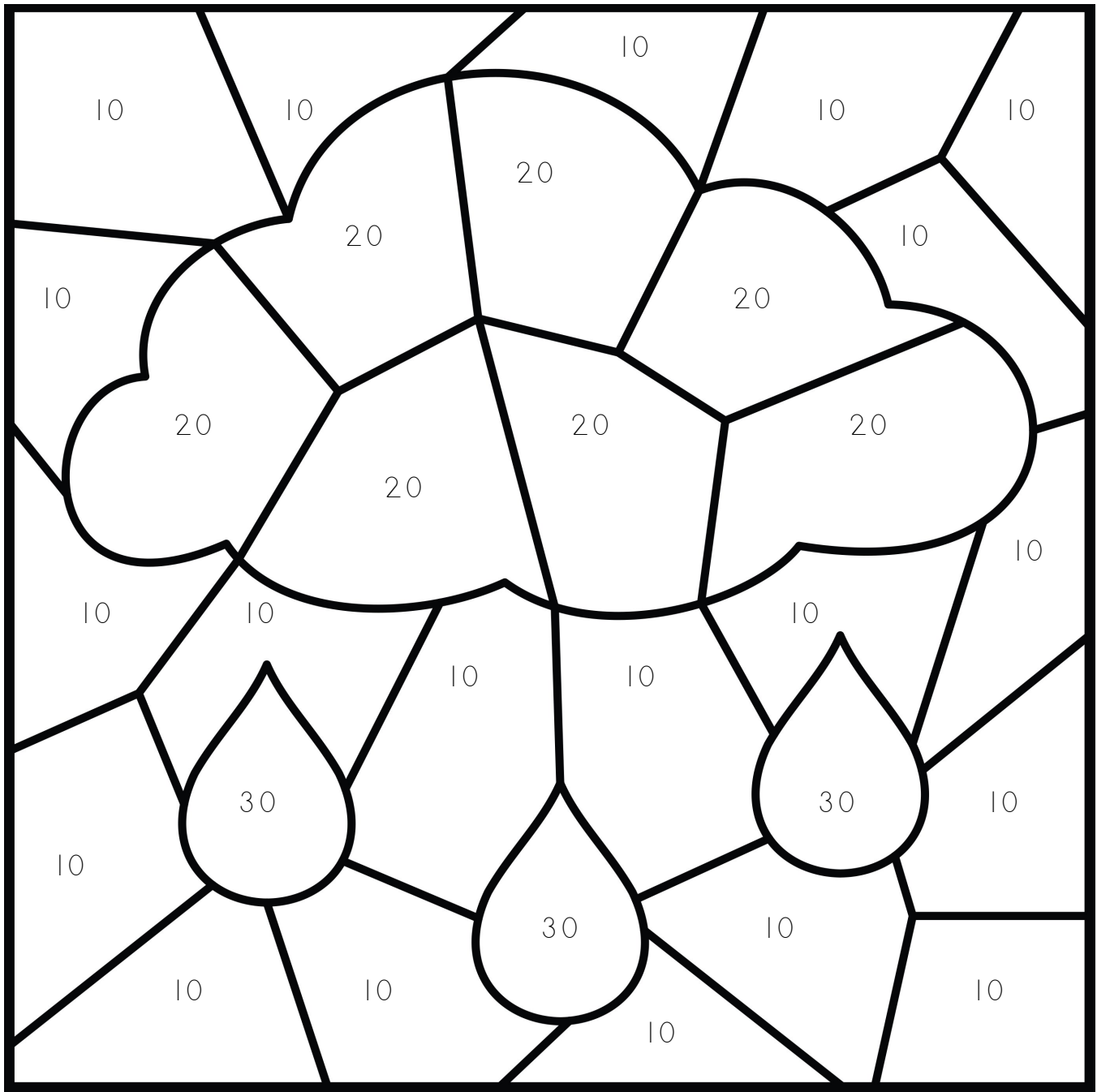

Follow the directions to color the picture.

Color the spaces with a 10 pink ●.



Color the spaces with a 20 gray ●.

Color the spaces with a 30 blue ●.

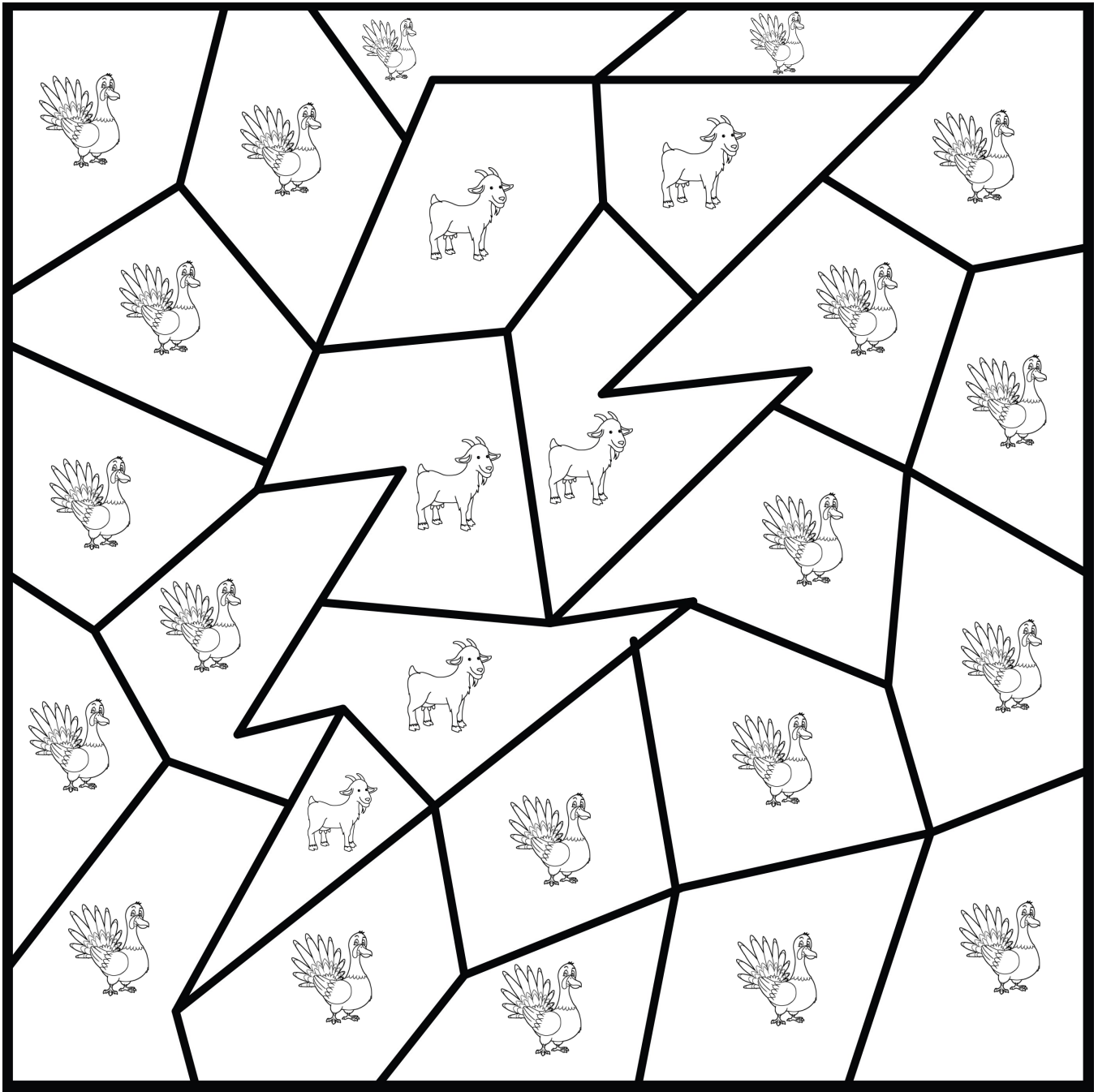
Color by Animal



Follow the directions to color the picture.

Color the spaces with a turkey  orange .

Color the spaces with a goat  yellow .

Color by Word

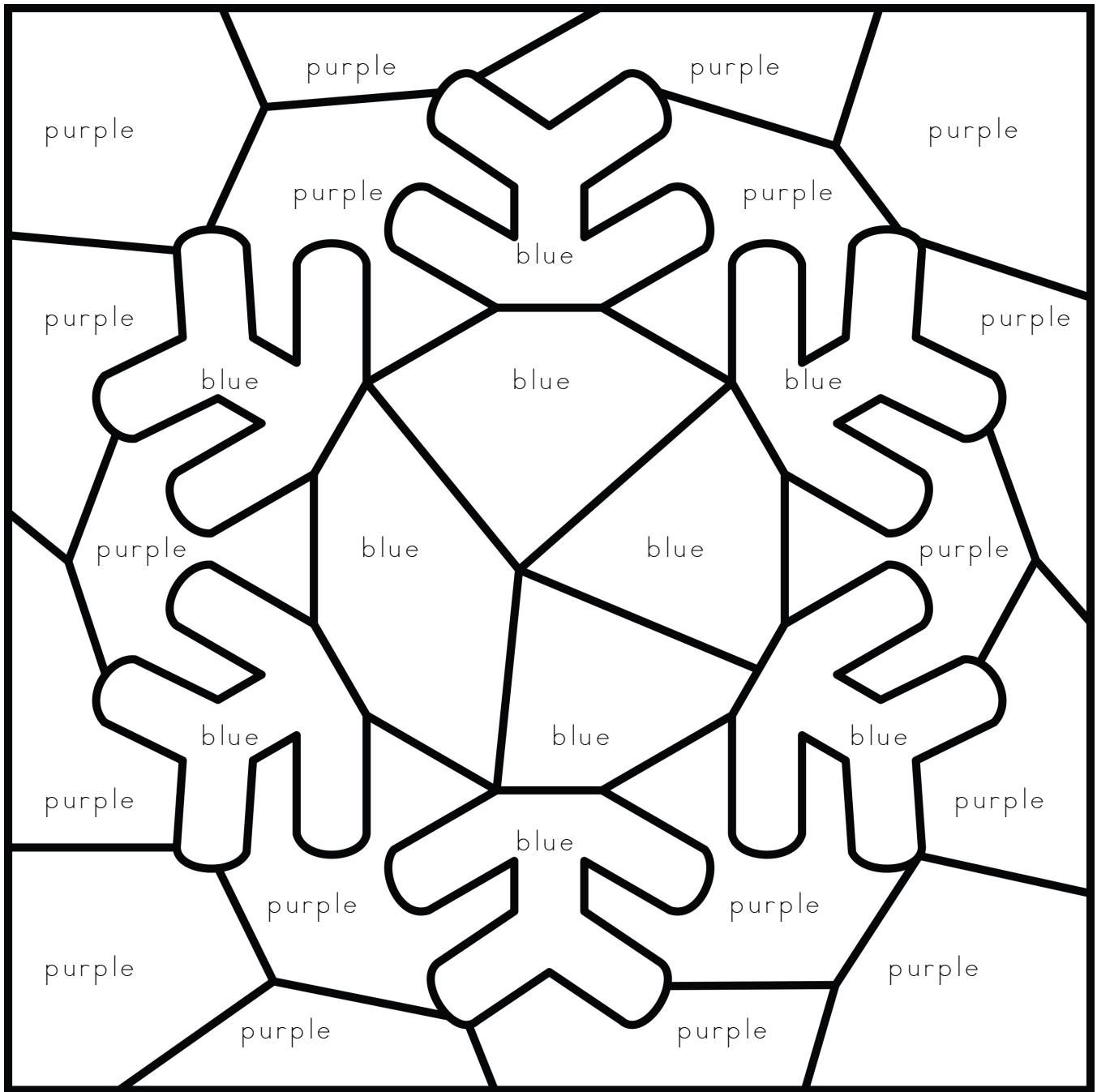

Follow the directions to color the picture.

Color the spaces with the word blue, blue ●.

Color the spaces with the word purple, purple ●.

Rain Cloud Tracing

Trace the lines to draw the rain cloud. You can color the picture if you like and draw something it is raining on.



Sunshine Tracing

Trace the lines to draw the sun. You can color the picture if you like and draw something the sun is shining on.

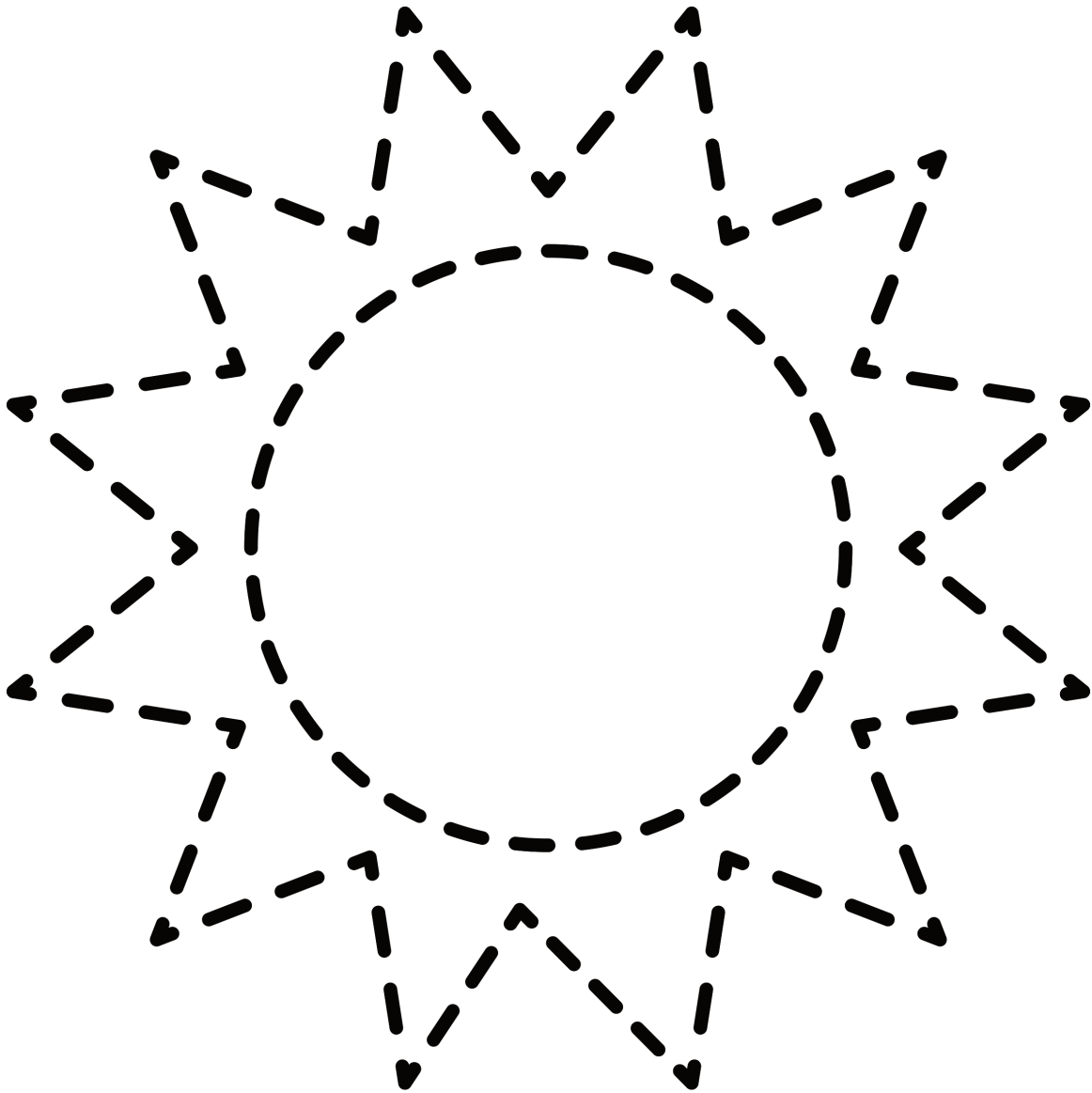

Sun and Cloud Tracing

Trace the lines to draw the sun and the cloud. Did you ever watch the clouds blow across the front of the sun and then see the sun peek out the other side? You can color the picture if you like.



Dot the Rainbow

Use a dauber to make the picture of the rainbow. Draw a picture that shows what the rainbow in the sky is stretching over.

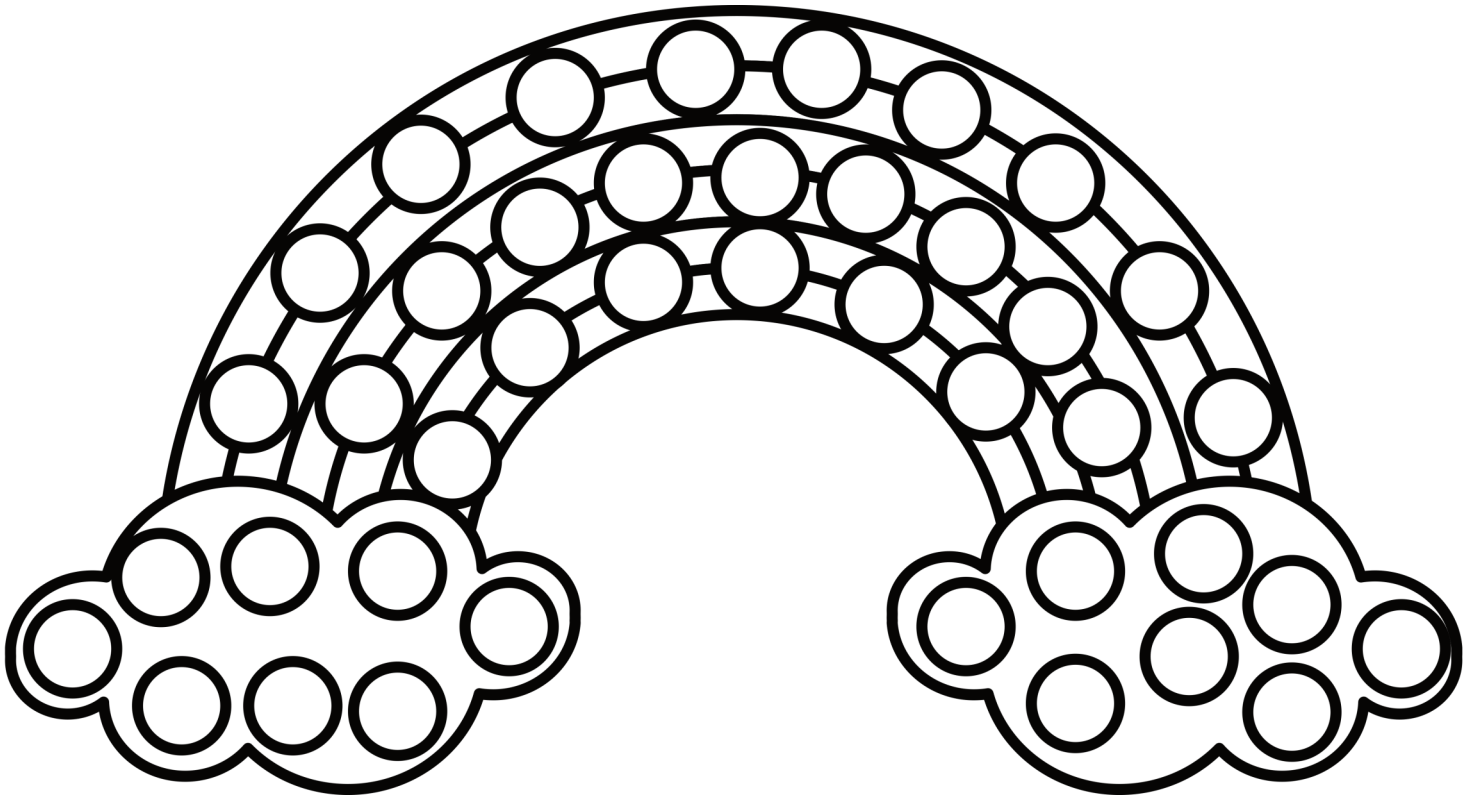

Dot the Rain Cloud

Use a dauber to make the picture of the rain cloud. Draw more raindrops for a really rainy day.



Dot the Sun

Use a dauber to make the picture of the sun. You can color the picture if you like.

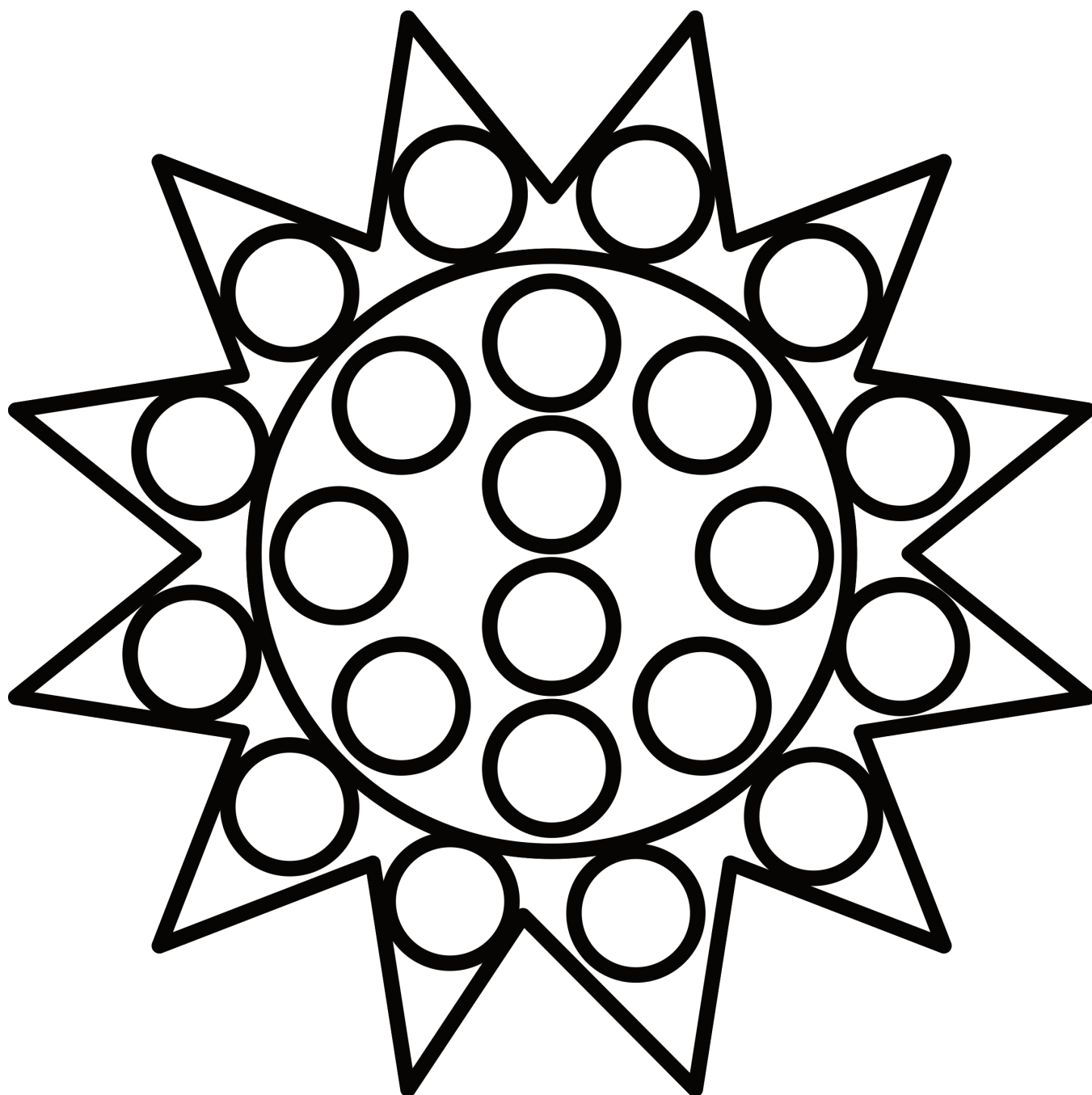

Count the Raindrops

Look at the clouds below. Count the raindrops falling from each cloud. Under the raindrops are three numbers. Circle the number that shows how many raindrops are falling from each cloud.



Count the Snowflakes

Look at the mittens below. Count the snowflakes on each mitten. Under each mitten are three numbers. Circle the number that shows how many snowflakes are on the mitten.

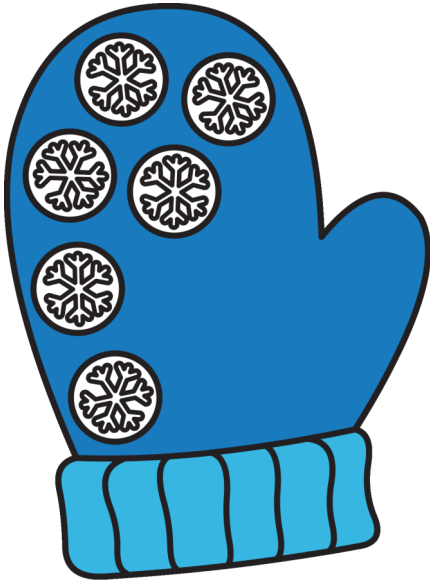

4 6 8

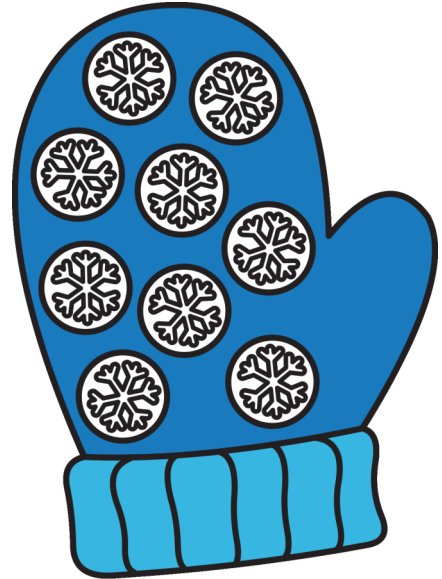

3 6 9

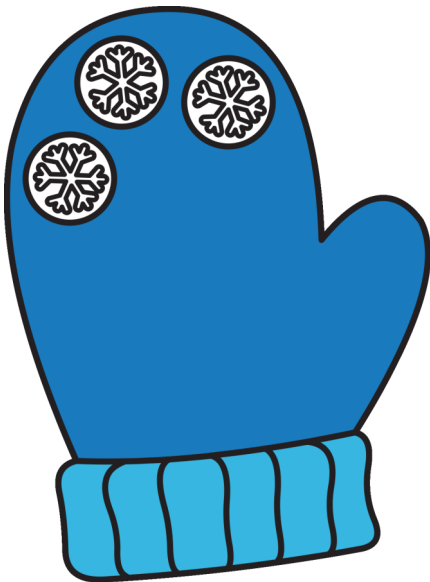

1 2 3

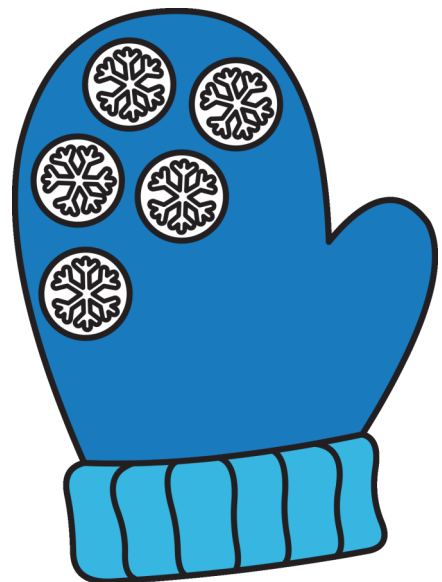

5 7 9

It's Going to Rain!

Did you ever watch how the way it looks outside changes when it is going to rain and after it has stopped raining? Put a number in the box below each picture to show how the day changes from a sunny day (1) to the rainbow that comes after the rain (4).

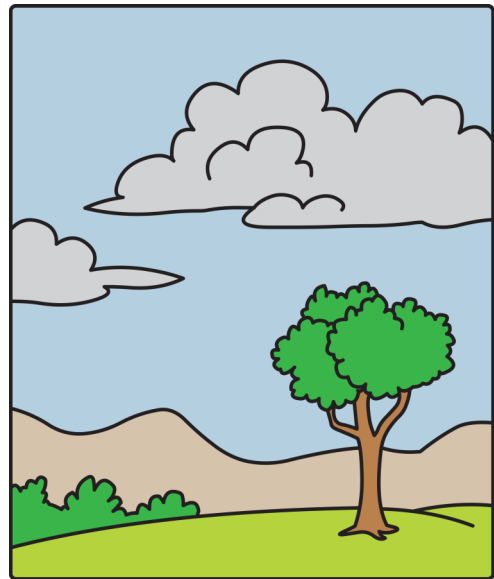
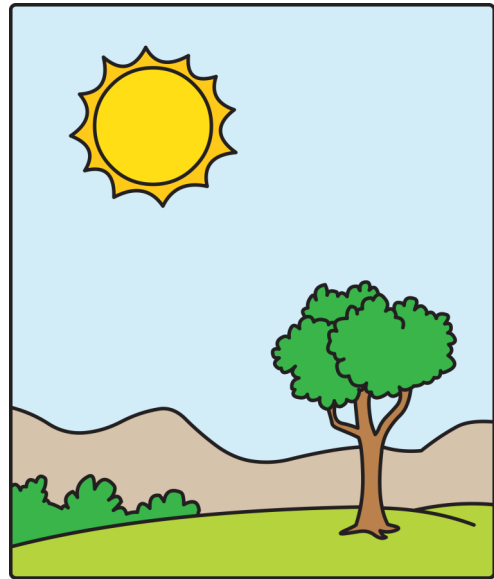
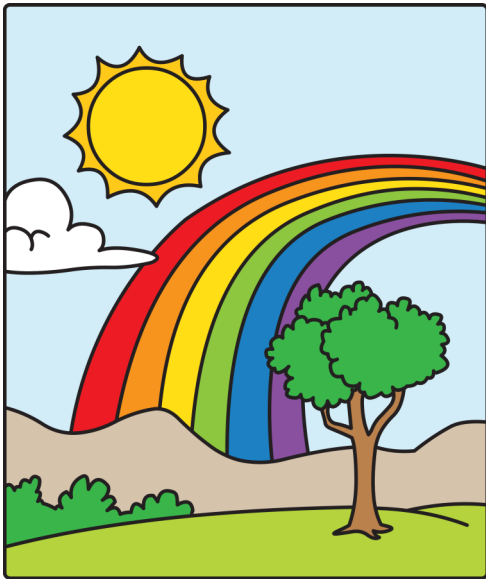

What Comes Next?

Look at each row of children dressed for different kinds of weather below. At the end, there is a space where the next person is missing. Draw a circle around the child who goes next in the row.



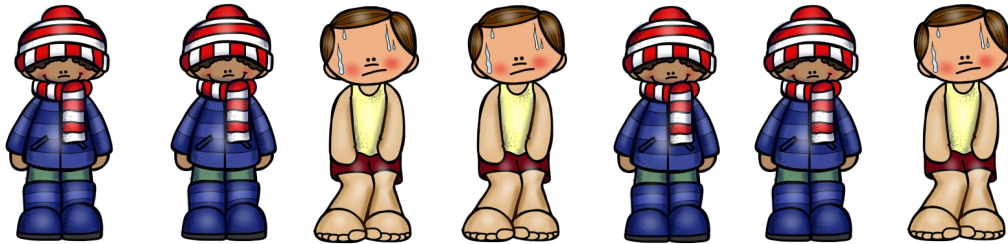





Let's Be Weather Forecasters

Put an X on the symbol that tells us it will be a sunny day. Draw a circle around the symbol that tells us it is going to rain. Draw a square around the symbol that tells us it is going to snow. Draw a triangle around the symbol that tells us it is going to rain and snow. Draw a rectangle around the symbol that helps us know what the temperature is.

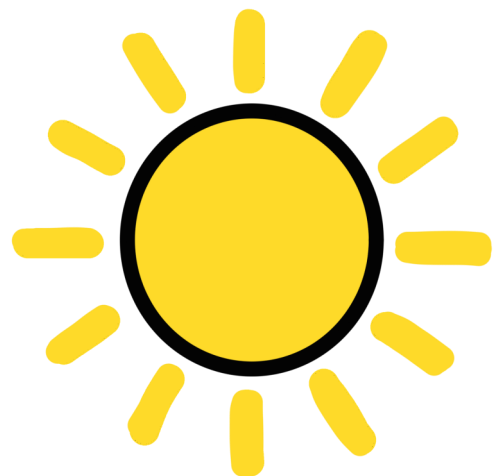
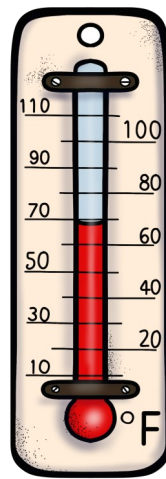

Color by Shape

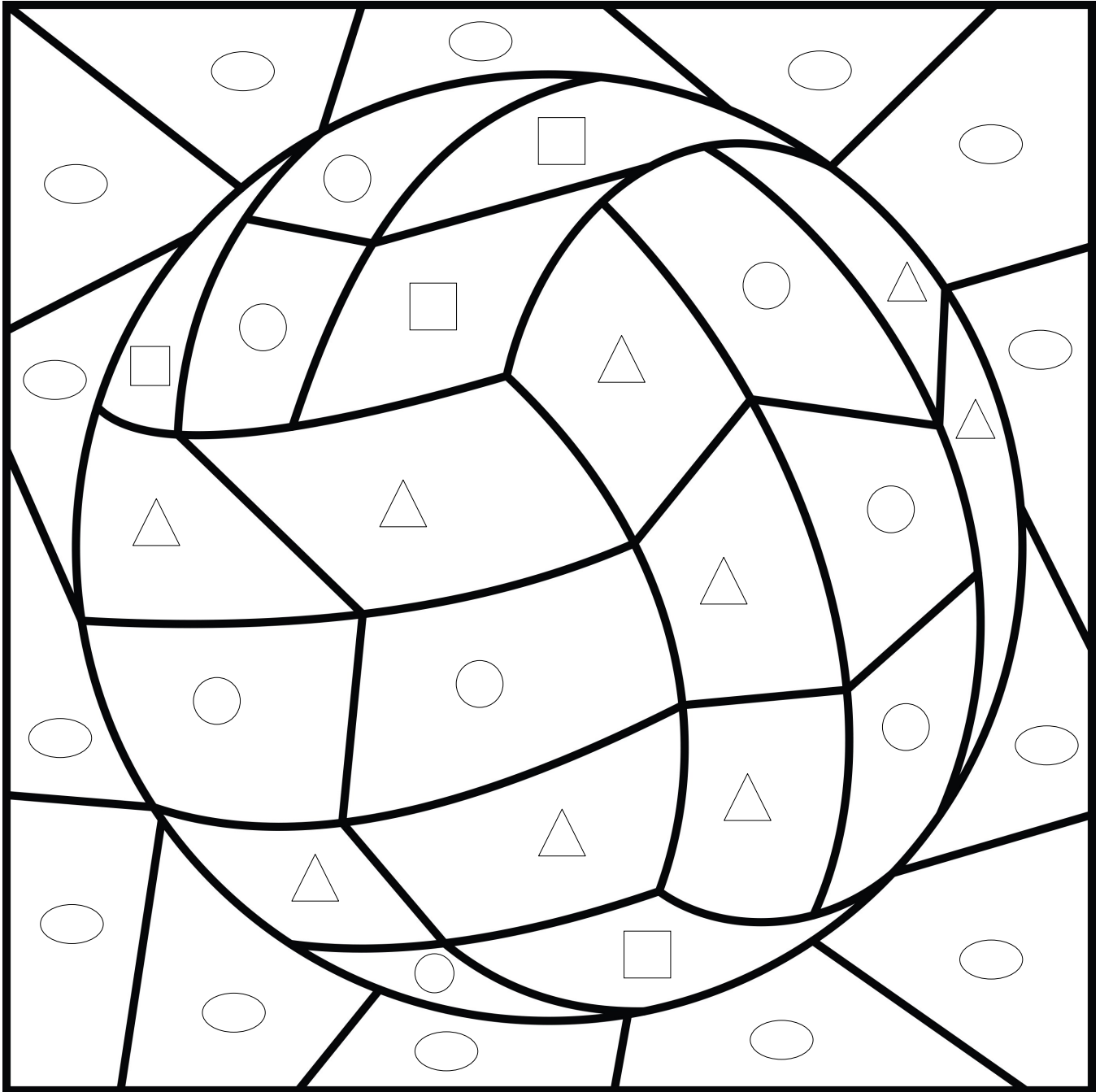

Follow the directions to color the picture.

Color the spaces with a circle  yellow .

Color the spaces with a triangle  orange .

Color the spaces with an square  brown .

Color the spaces with an oval  blue .

Color by Number

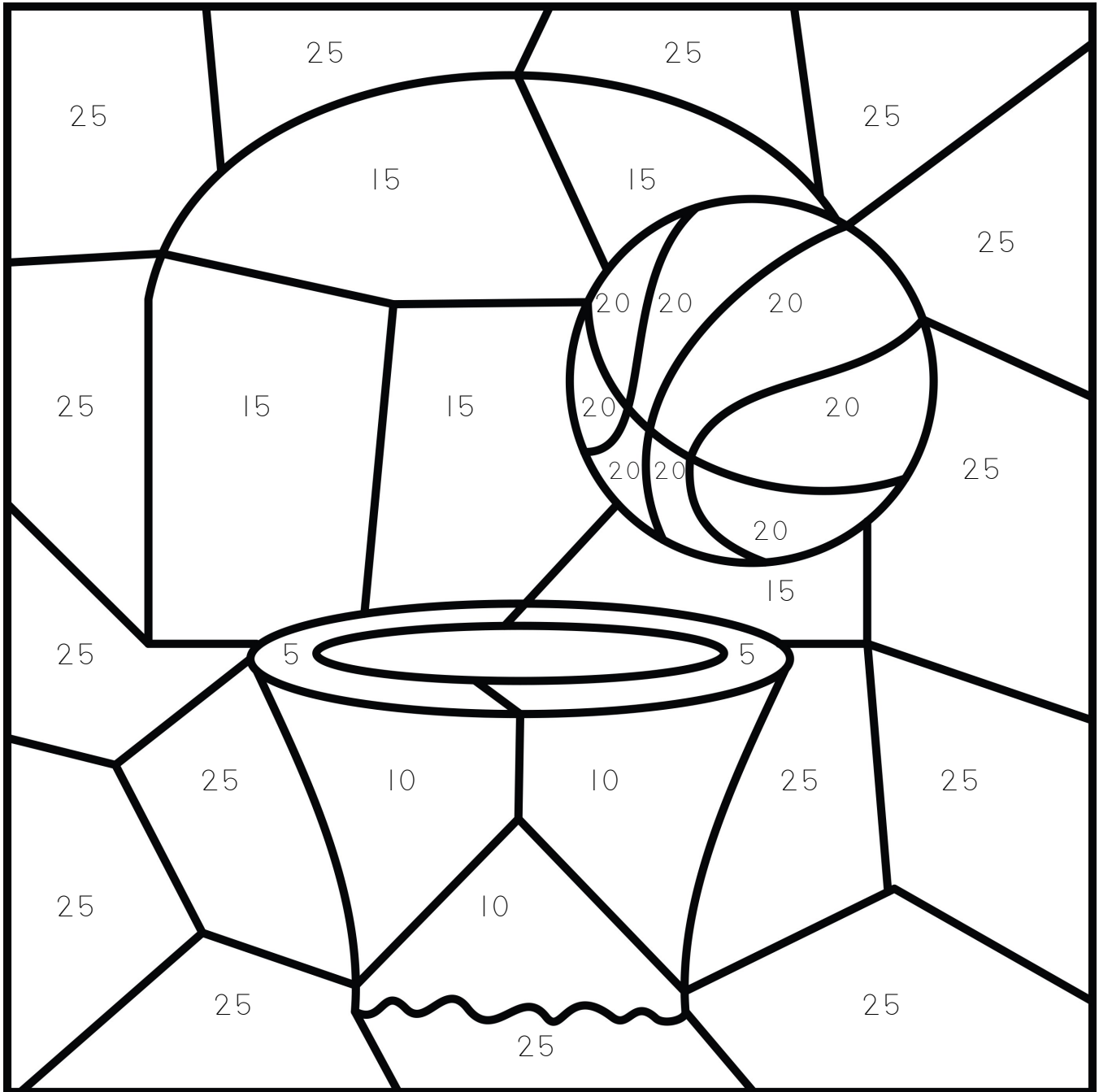

Follow the directions to color the picture.

Color the spaces with a 5 red ●.

Color the spaces with a 10 gray ●.

Color the spaces with a 15 blue ●.

Color the spaces with a 20 orange ●.

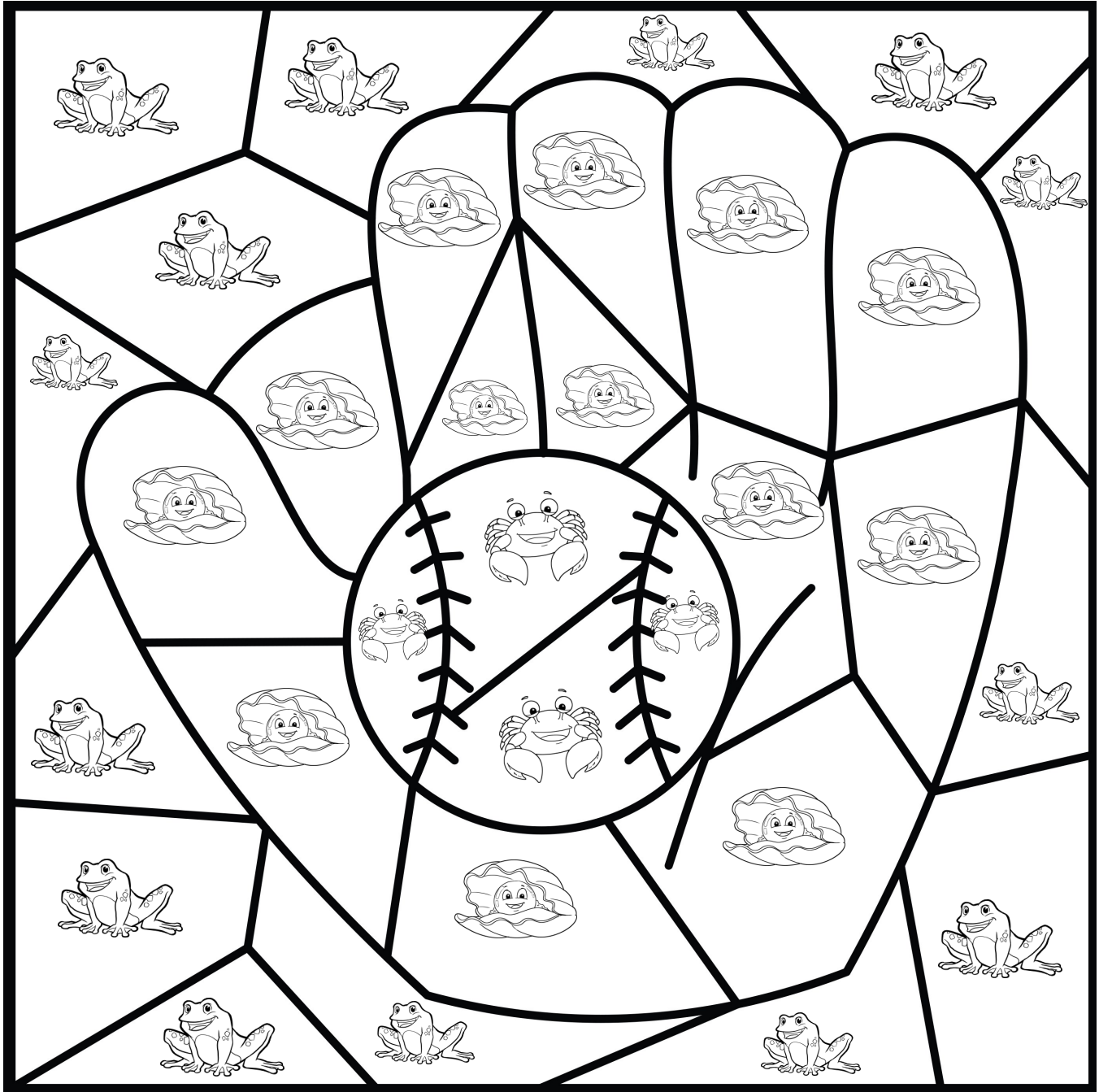

Color the spaces with a 25 yellow ●.

Color by Animal



Follow the directions to color the picture.

Color the spaces with a clam  brown .

Color the spaces with a crab  yellow .

Color the spaces with a frog  red .

Color by Word

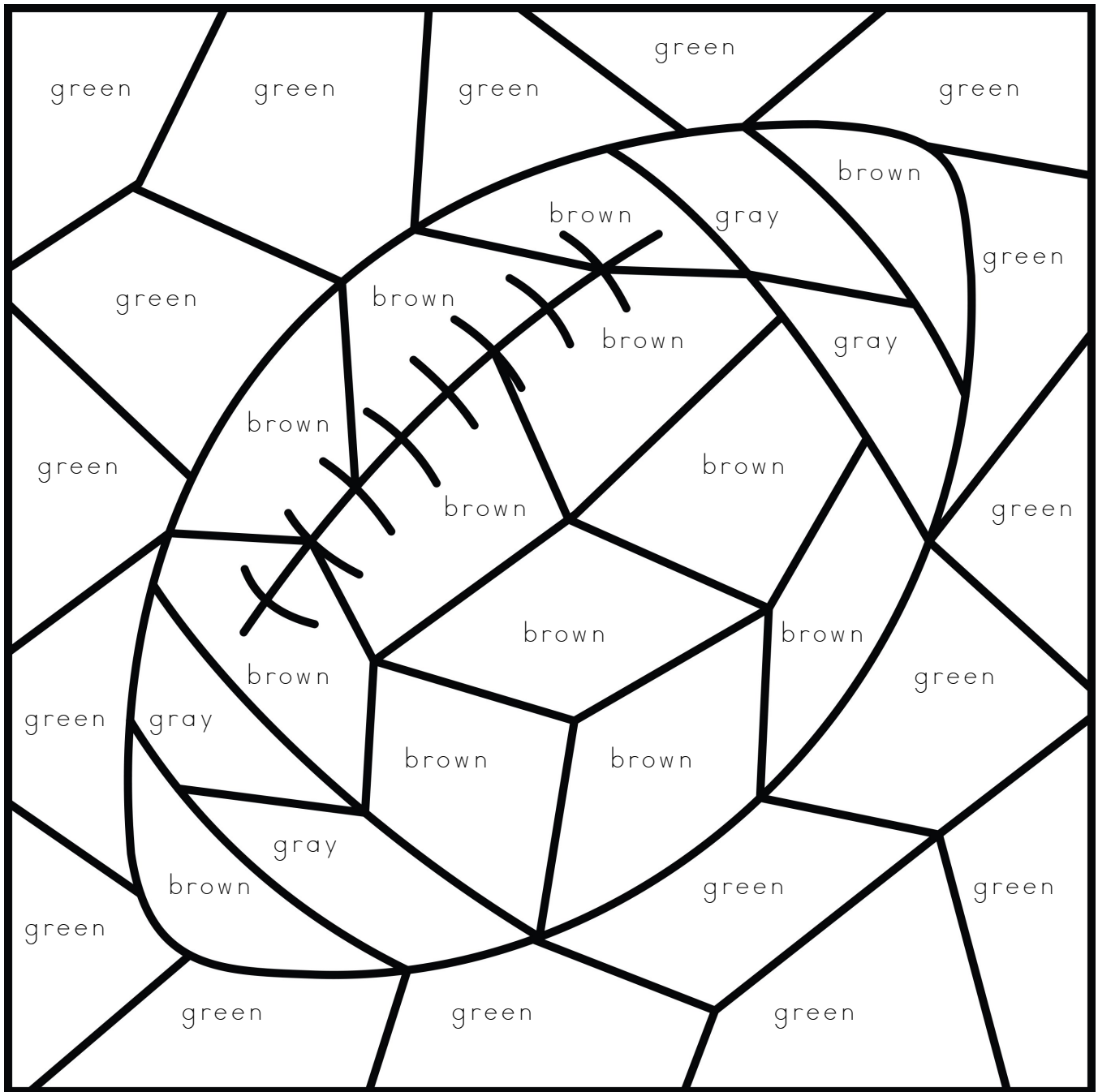

Follow the directions to color the picture.

Color the spaces with the word brown, brown .

Color the spaces with the word green, green .

Color the spaces with the word gray, gray .

Golf Tracing

Trace the lines to draw the golf club and the green. Have you ever played golf? You can color the picture if you like.

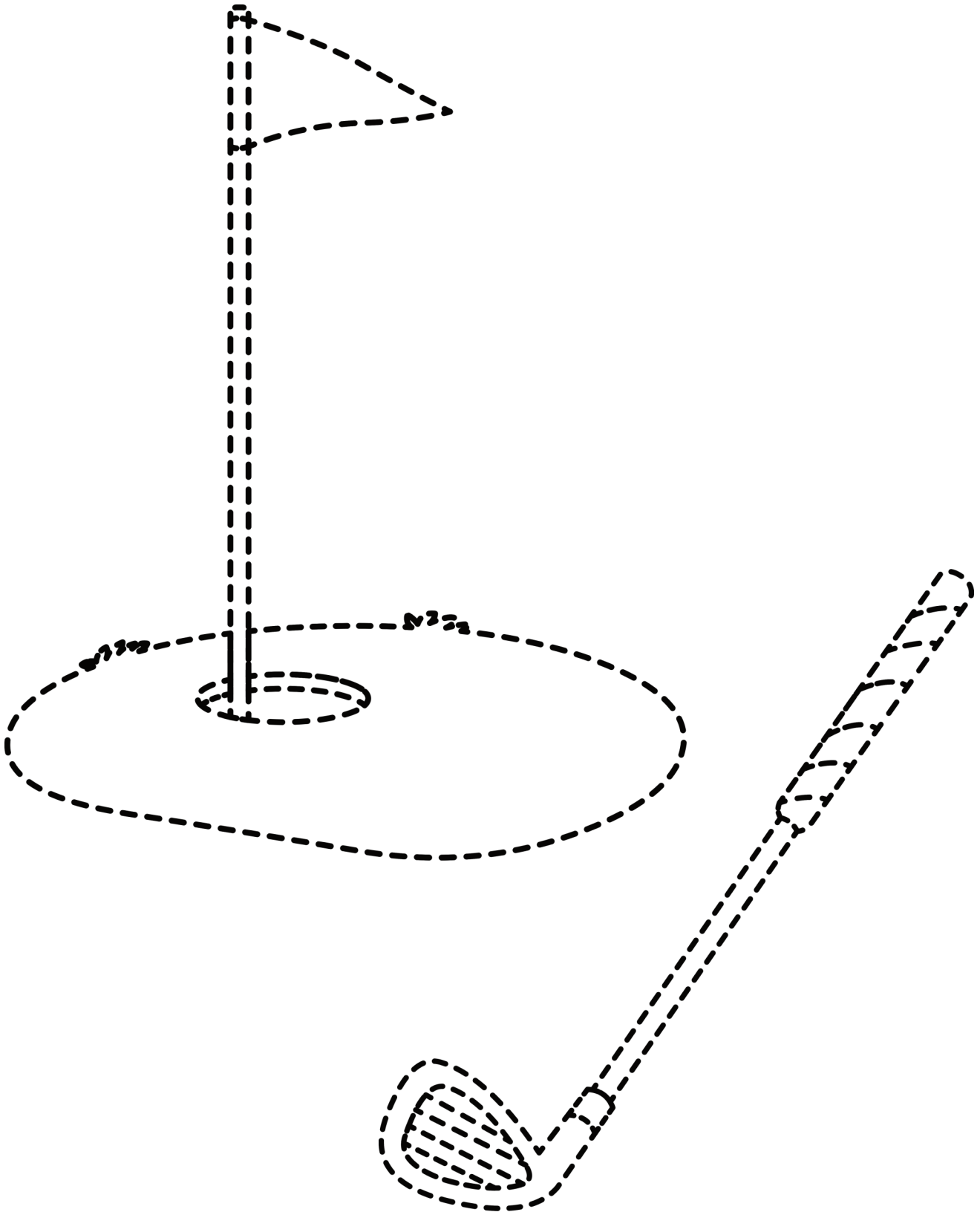

Football Tracing

Trace the lines to draw the football and the helmet. Do you have a favorite football team? You can color the picture with the colors of your favorite team if you like.

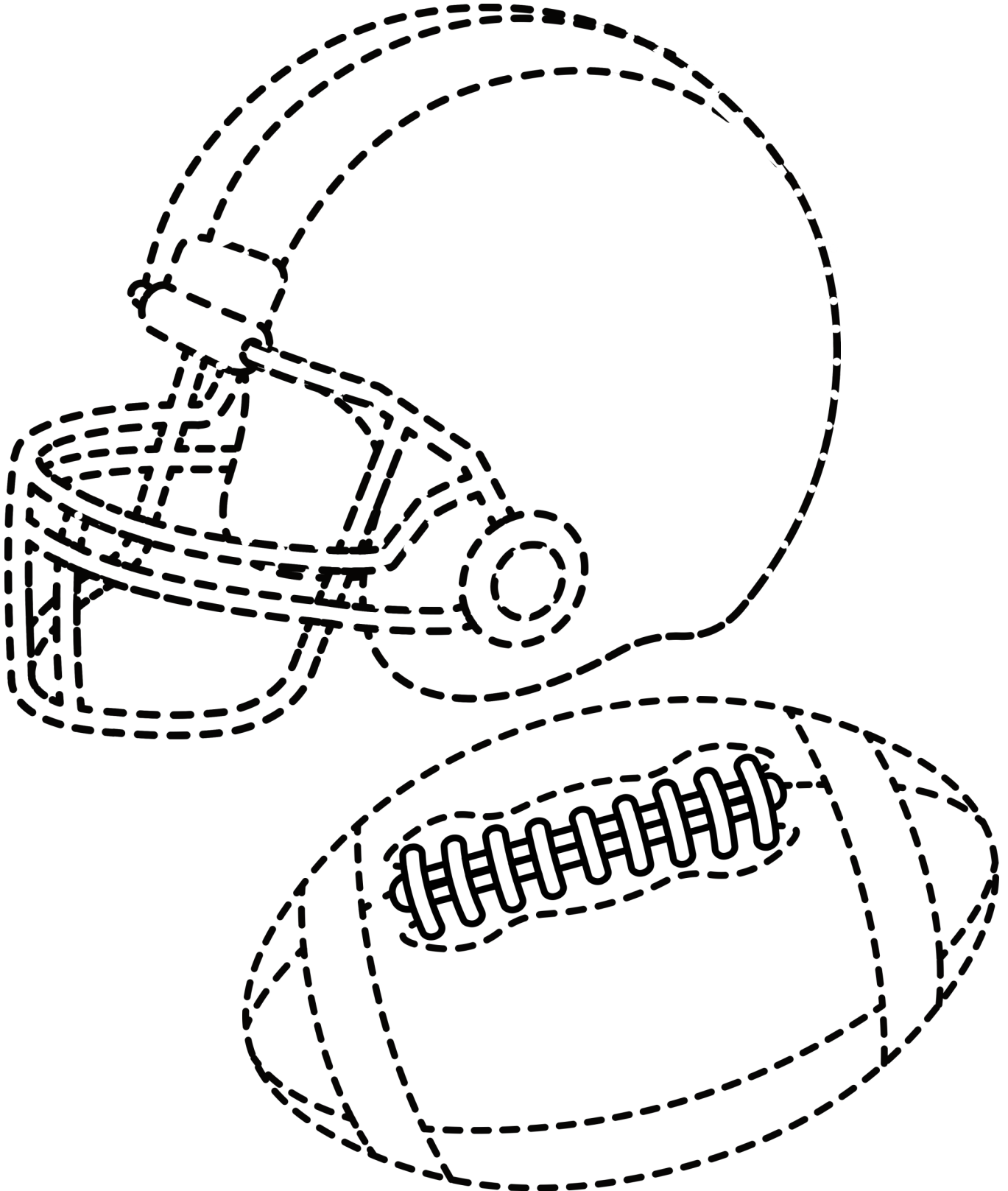

Baseball Tracing

Trace the lines to draw the baseball and the bat. Do you like baseball? You can color the picture if you like.

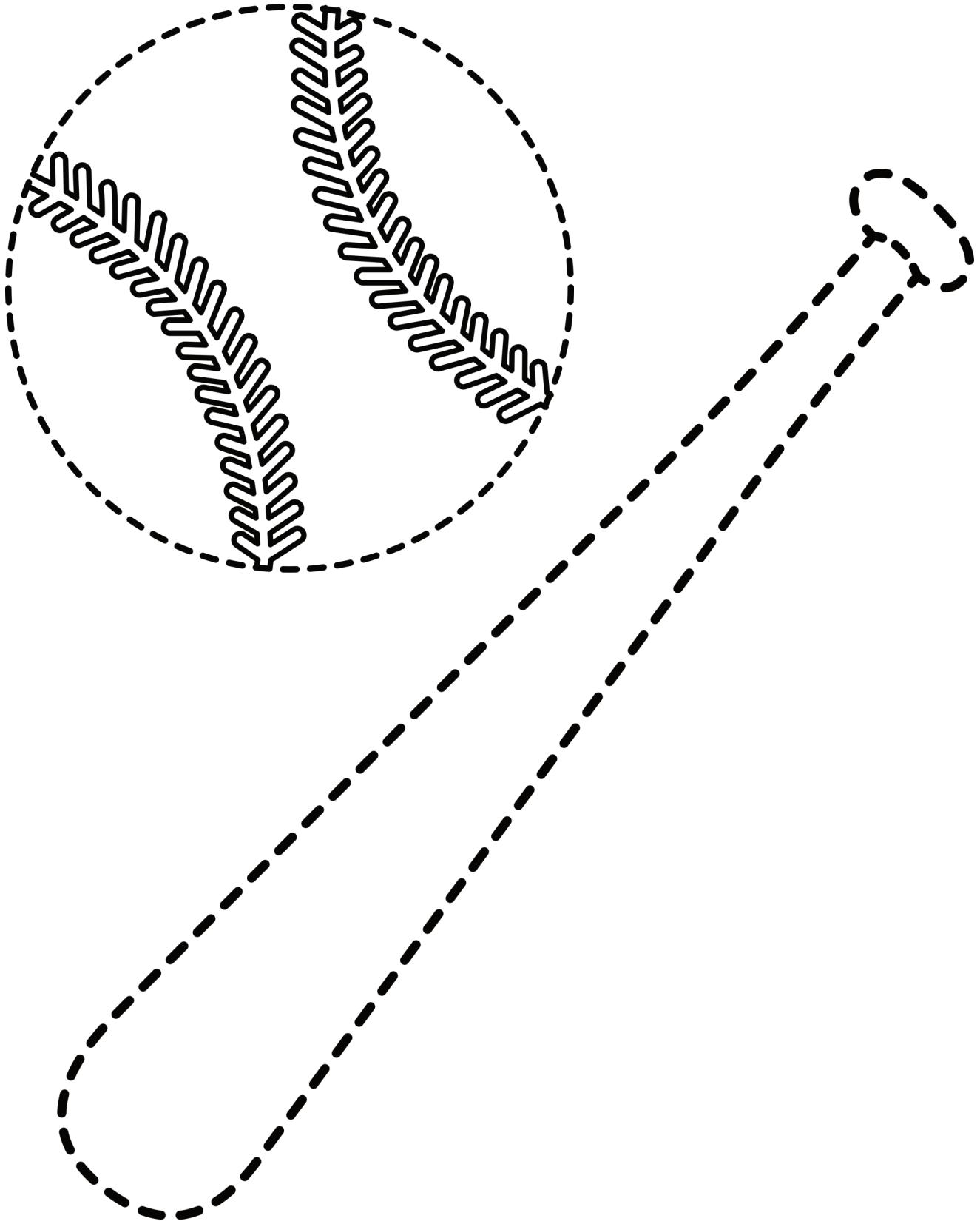

Soccer Tracing

Trace the lines to draw the soccer ball and shoe. Do you have a favorite soccer team? You can color the picture with the colors of your favorite team if you like.



Find Your Way to the Green

Help the boy playing golf get the ball to the green.

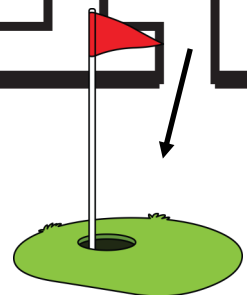
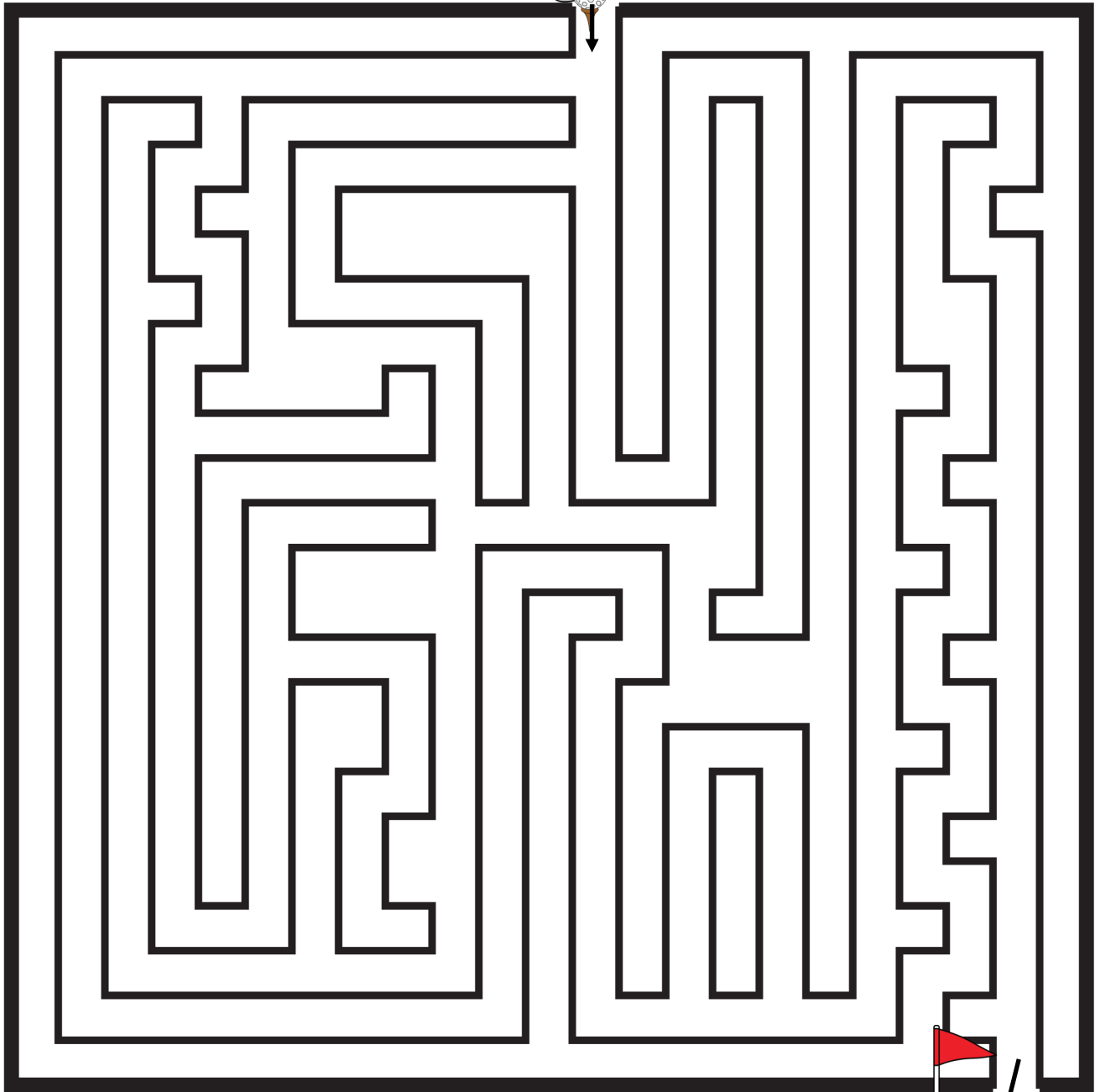

Find Your Way to the Goal

Trace the way each football went after it was kicked.

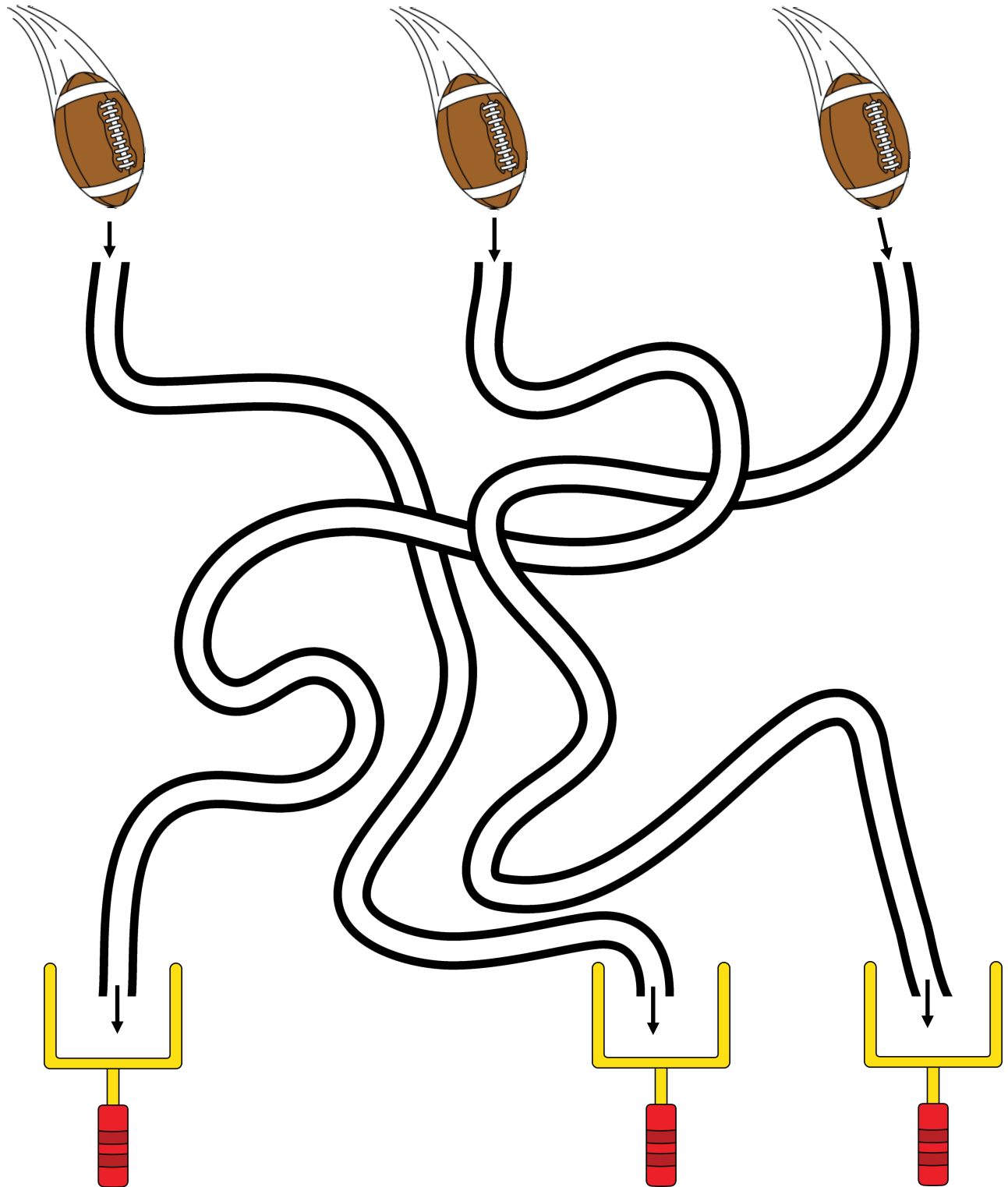

Count the Baseballs

Look at the groups of baseballs below. Under each group of baseballs are three numbers. Circle the number that shows how many baseballs are in that group.



1

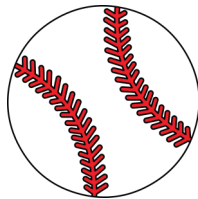

2

3

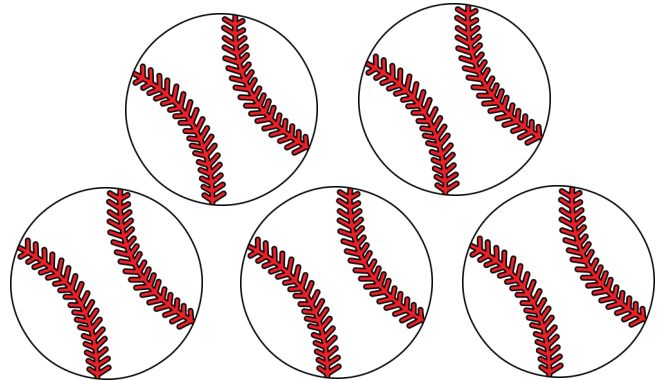

1

3

5

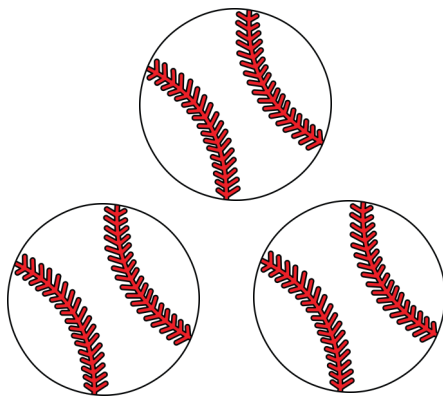

3

5

7

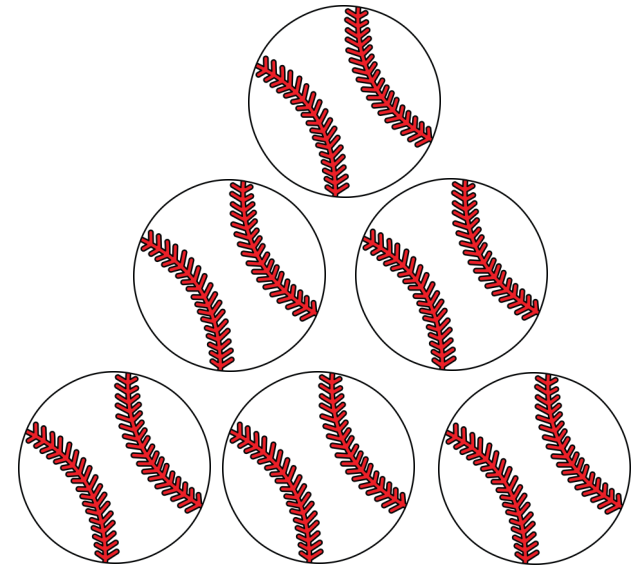

5

6

7

Sports Matching

Match the sports equipment to the part of the court or playing field it goes with.

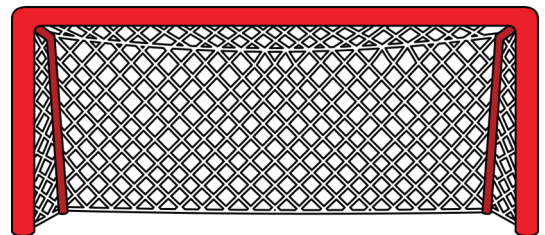
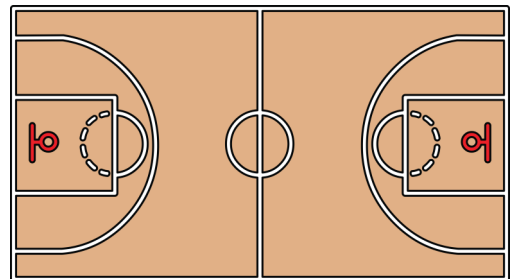
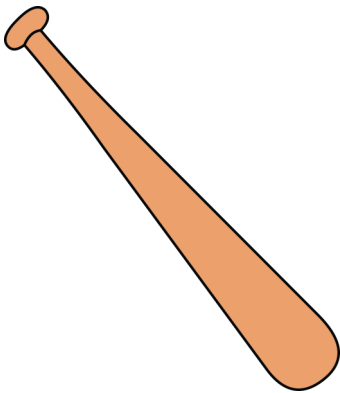
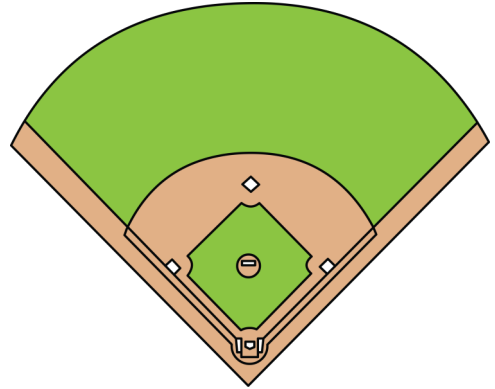

Sports Matching

Match the sports equipment on the right side to what it goes with on the left side.

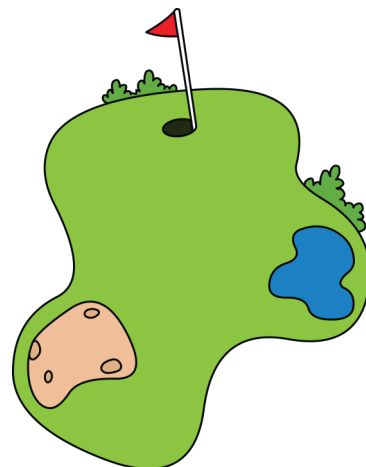
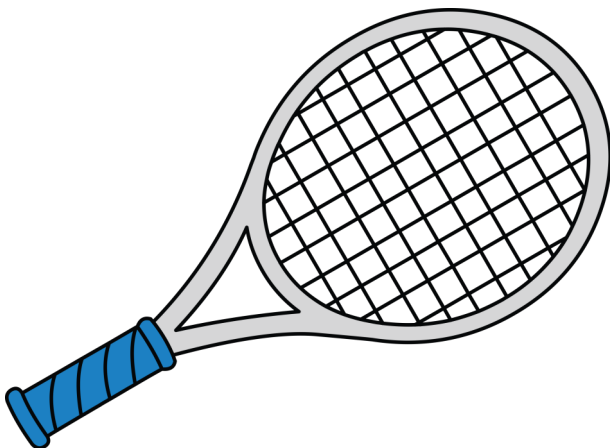
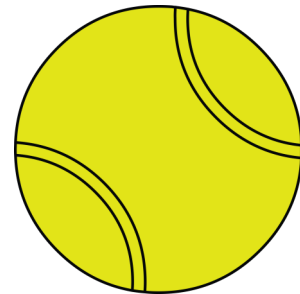
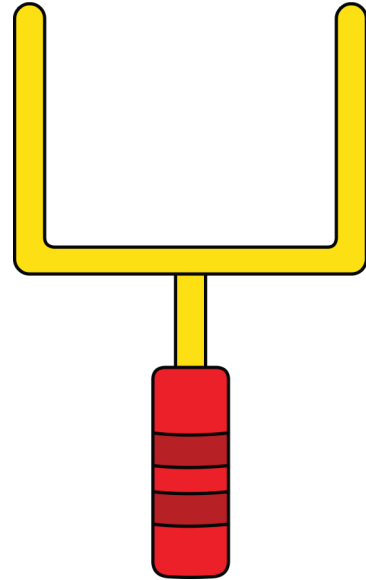
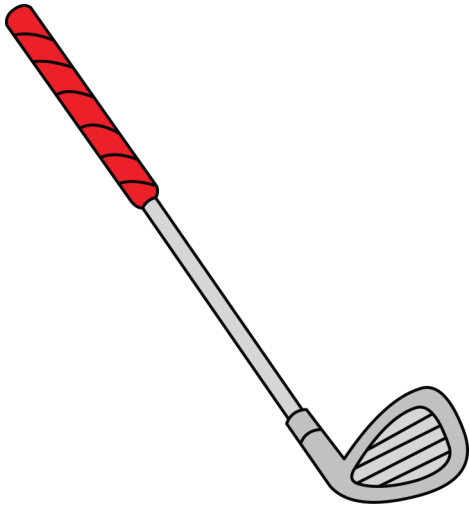

What Comes Next?

Look at each row of sports equipment below. At the end there is a space where the next piece of equipment is missing. Draw a circle around the piece of equipment that goes next in the row.

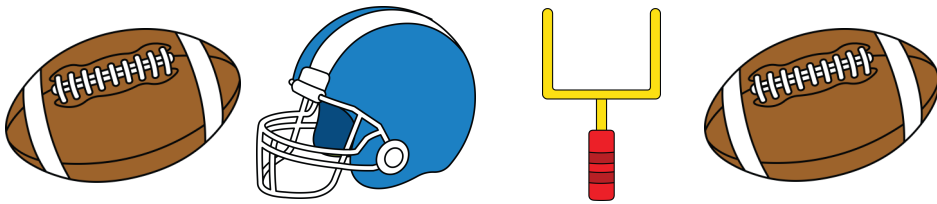
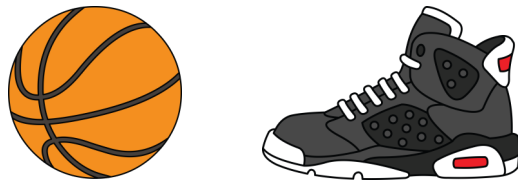

On the Same Team

Look at how the basketball players are dressed. Draw a circle around the players on the same team.

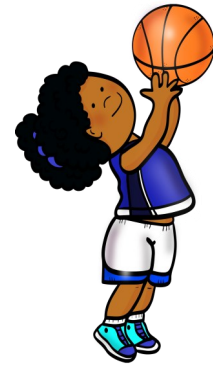

Look at the hats the baseball players are wearing. Draw a circle around the players that are on the same team.



Look at the soccer players. Color two of them with the same color uniforms to show they are on the same team. Color the other one with a different color uniform.





Thank you for downloading my product! I pray it is a blessing to you and your family. If you'd like to view more of my products and freebies, you'll find them at WriteBonnieRose.com. I am adding new material almost every week, so please check back often or sign up to receive my newsletter so you don't miss a thing.

At WriteBonnieRose.com, you'll find:

- Resources for Teaching Kids About the Persecuted Church and Unreached People Groups
- Copywork
- History Resources and Printables
- Holiday Resources and Printables
- Coloring Pages
- Notebooking Pages
- Timeline Worksheets and Resources
- Short Stories for Kids
- Writing Opportunities
- How to Write for Homeschoolers

I'd love to connect with you! In addition to my website, you can find me on:

[CurrClick](#)
[Educents](#)
[Teachers Pay Teachers](#)
[Teacher's Notebook](#)
[Facebook](#)
[Pinterest](#)
[Twitter](#)
[Google+](#)
[LinkedIn](#)

