

Master Word List

CH words: chair, chimpanzee, chicken, bench

CK words: sock, clock, duck, kick

CR words: crab, crushed can, crayon, crocodile

DGE words: judge, bridge, fridge, badge

FL words: flip flops, flamingo, flag, flower

GR words: grapes, groundhog, groceries, grocery cart

ING words: king, sing, swing, ring

KN words: knight, knit, knob, knot

ND words: sand, diamond, hand, wand

NK words: skunk (or stink), bank, sink, trunk

NT words: tent, ant, elephant, paint

PH words: phone, photographs, pharaoh, photographer

SH words: shoe, brush, fish, ship

SL words: sleep, slip, sloth, sled

SN words: snake, sneaker, snail, snowman

ST words: nest, stamp, stop, stove

TCH words: catch, scratch, match, hatch

TH words: thread, thermometer, tooth, wreath

TR words: tree, trash, train, tractor

WH words: wheel, whistle, whisk, whale

Bonus words: BL: blue, block; FR: French fries, frog

Bonus words: GL: globe, glue; SK: skunk, skateboard

Please note: key letters may be found either at the beginning or the end of the word.

Cut out the pictures of the words that contain the letters CH and paste them into the correct spaces.

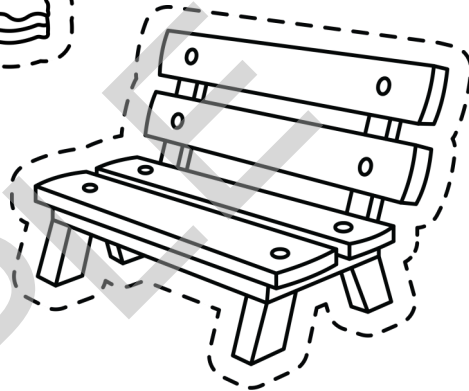
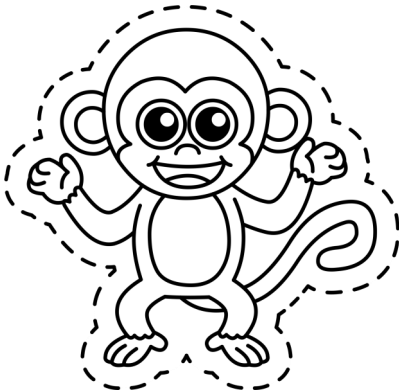
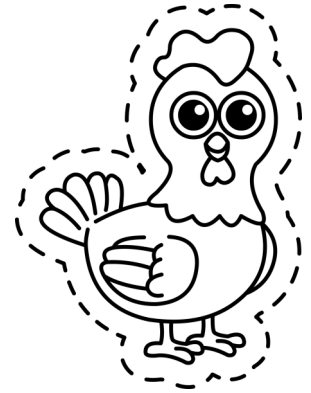
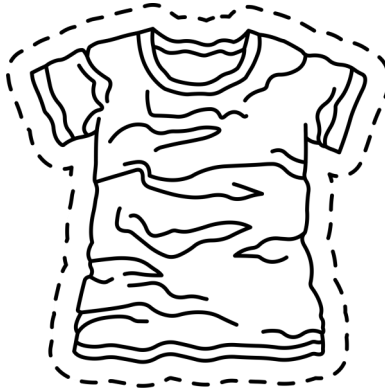
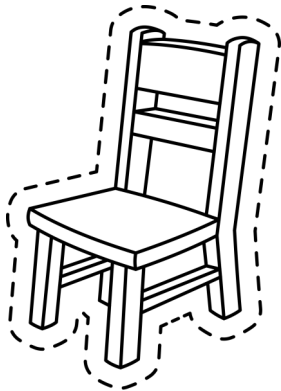

Cut out the pictures of the words that contain the letters CK and paste them into the correct spaces.

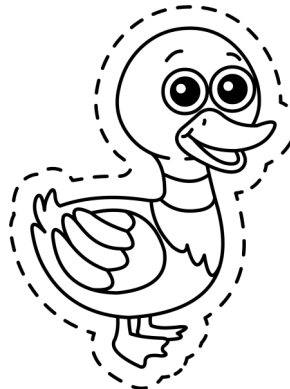
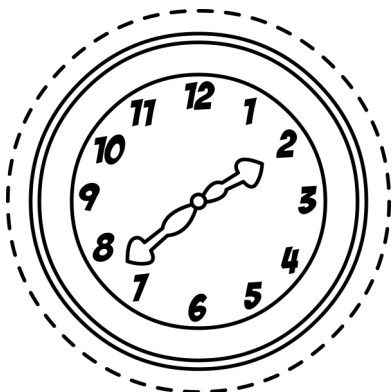
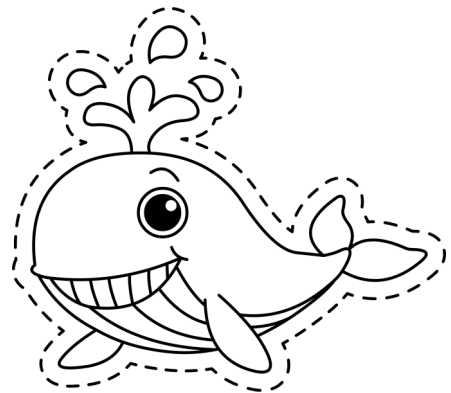
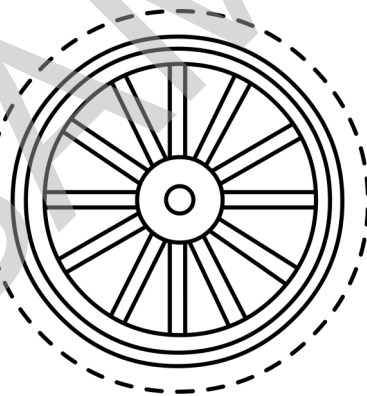
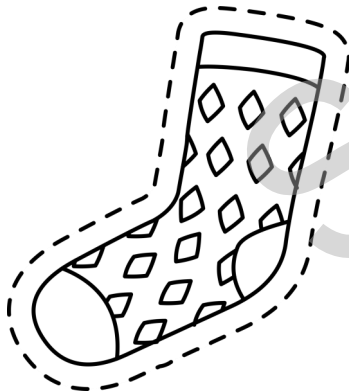

Cut out the pictures of the words that contain the letters CR and paste them into the correct spaces.

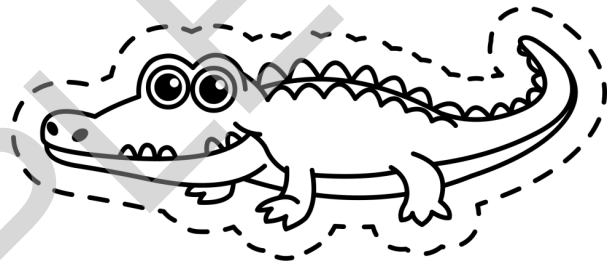
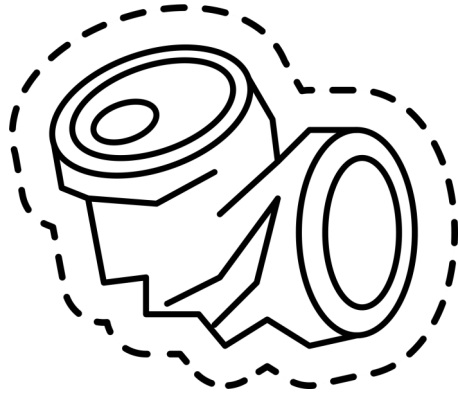
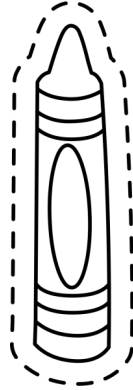
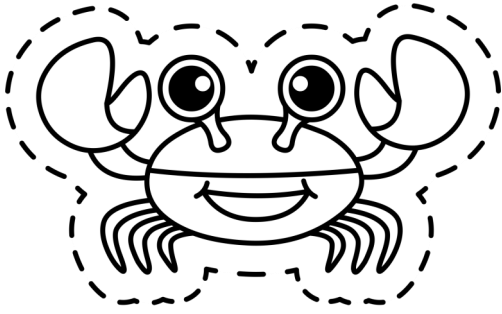

Cut out the pictures of the words that contain the letters DGE and paste them into the correct spaces.

