



CHRISTMAS FOODS
AROUND THE WORLD
Notebooking Journal

BY BONNIE ROSE HUDSON

Please Note: Some of the foods in this book are similar dishes with similar names. They are included more than once because the different names reflect different countries and variations in traditions and ingredients.

Copyright © 2021 by WriteBonnieRose, LLC



Select graphics used courtesy of [Artifex](#), [Caroline C Illustration](#), [ChalkStar](#), [Clip Art That Cares](#), [Clipartino](#), [EduClips](#), [Hidesy's Clipart](#), [I 365 Art](#), [Kari Bolt Clip Art](#), [Lovely Jubblies Teach](#), [RamonaM ClipArt](#), and [Zip-a-Dee-Doo-Dah Designs](#).

Please note: All information about these foods can be found through research. The foods do not need to be prepared or tried. Parents and teachers must always consider and be responsible for potential food allergies before preparing any foods for their students.

All Rights Reserved. This book may not be reproduced or transmitted by any means, including graphic, electronic, or mechanical, without the express written consent of the author except in the case of brief quotations embodied in critical articles and reviews and those uses expressly described in the following Terms of Use. You are welcome to link back to the author's website, <http://writebonnierose.com>, but may not link directly to the PDF file. You may not alter this work, sell or distribute it in any way, host this file on your own website, or upload it to a shared website.

Terms of Use: For use by a family, this unit can be printed and copied as many times as needed. Classroom teachers may reproduce one copy for each student in his or her class. Members of co-ops or workshops may reproduce one copy for up to fifteen children. This material cannot be resold or used in any way for commercial purposes. Please contact the publisher with any questions.

Christmas Foods Around the World

Antipasto

In what country/countries is it part of Christmas?

How is it part of Christmas traditions?

How is it made, and what are its main ingredients?

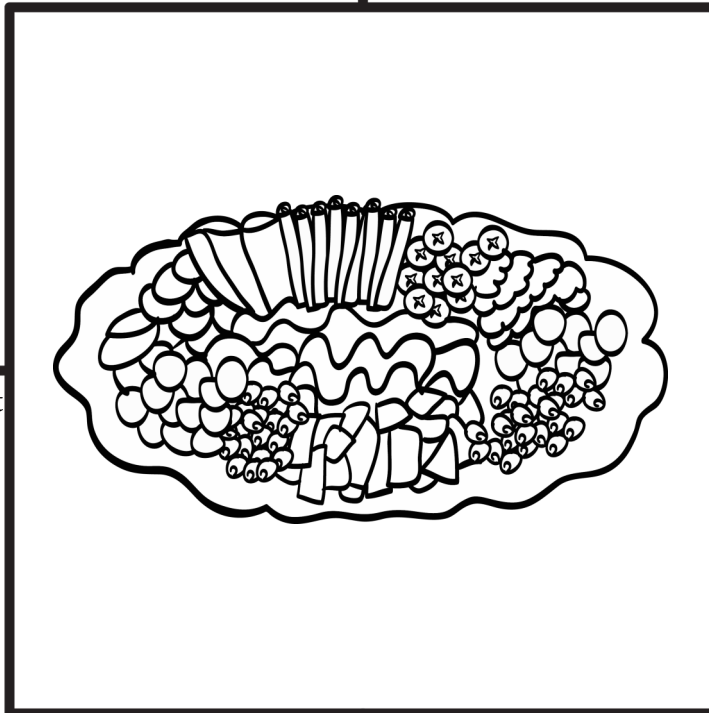

Is it served by itself or with something else (if so, what)?

Christmas Foods Around the World

Bacalao

In what country/countries is it part of Christmas?

How is it part of Christmas traditions?

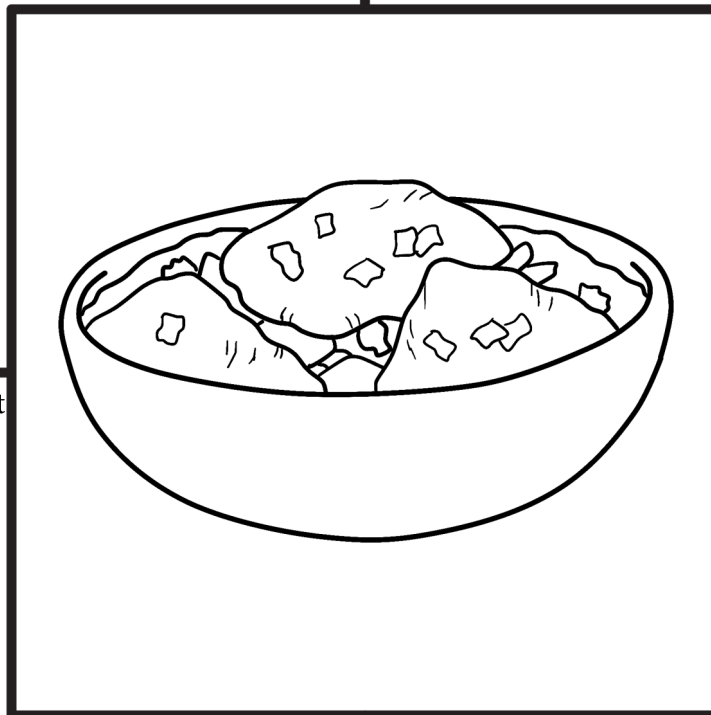

How is it made, and what are its main ingredients?

Is it served by itself or with something else (if so, what)?

Christmas Foods Around the World

Bacalhau

In what country/countries is it part of Christmas?

How is it part of Christmas traditions?

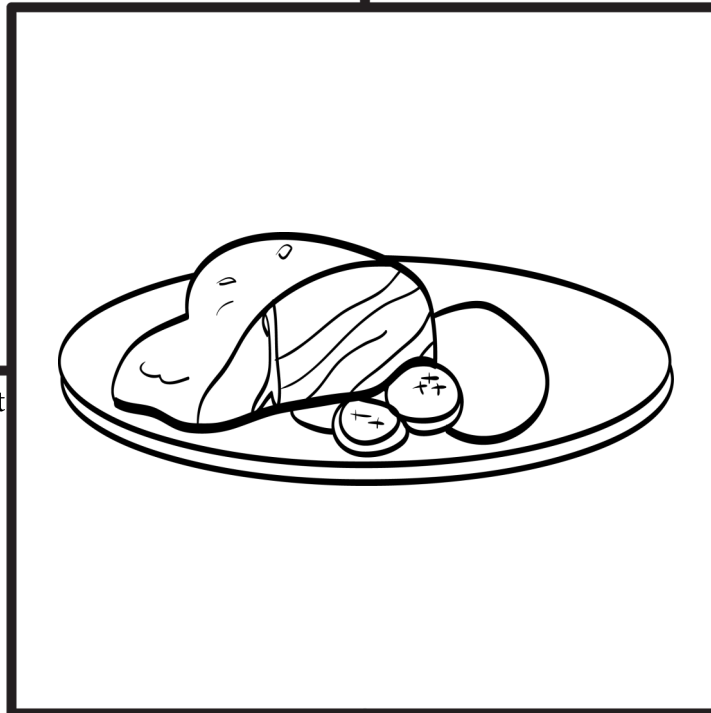

How is it made, and what are its main ingredients?

Is it served by itself or with something else (if so, what)?

Christmas Foods Around the World

Bibingka

In what country/countries is it part of Christmas?

How is it part of Christmas traditions?

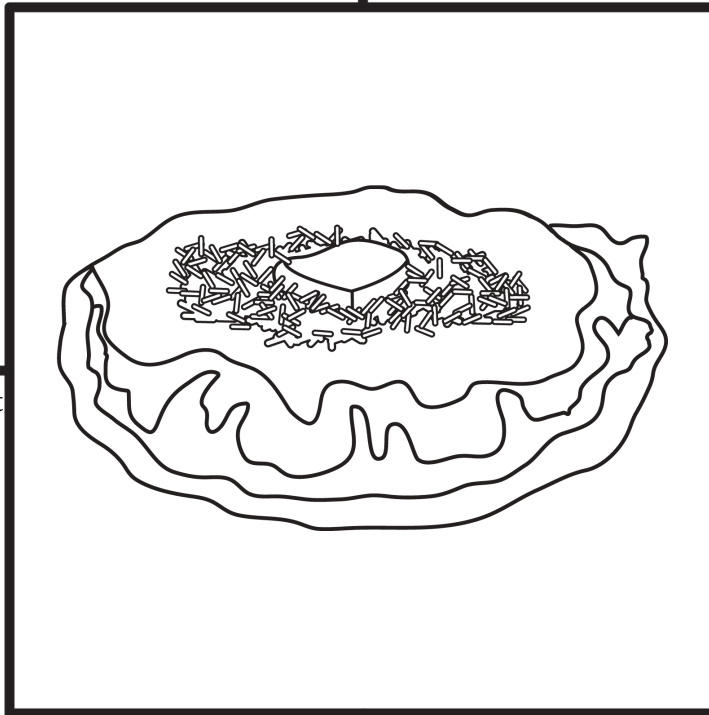

How is it made, and what are its main ingredients?

Is it served by itself or with something else (if so, what)?

Christmas Foods Around the World

Borsch (Borscht)

In what country/countries is it part of Christmas?

How is it part of Christmas traditions?

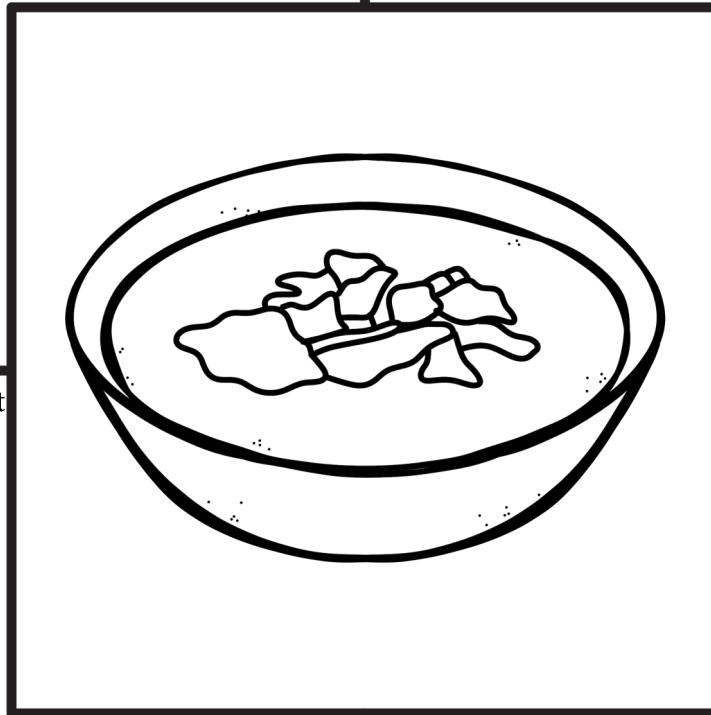

How is it made, and what are its main ingredients?

Is it served by itself or with something else (if so, what)?

Christmas Foods Around the World

Brazilian Christmas Rice

In what country/countries is it part of Christmas?

How is it part of Christmas traditions?

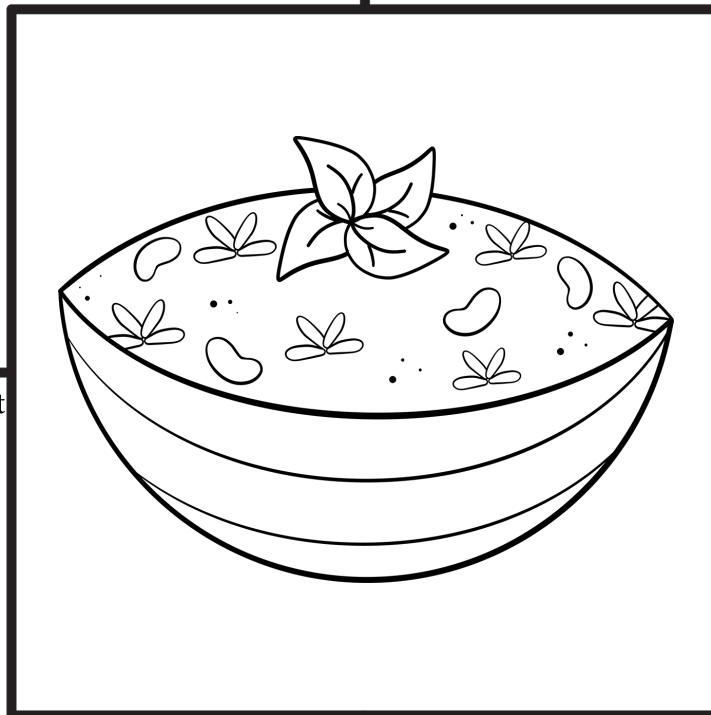

How is it made, and what are its main ingredients?

Is it served by itself or with something else (if so, what)?

Christmas Foods Around the World

Brazil Nut Pie

In what country/countries is it part of Christmas?

How is it part of Christmas traditions?

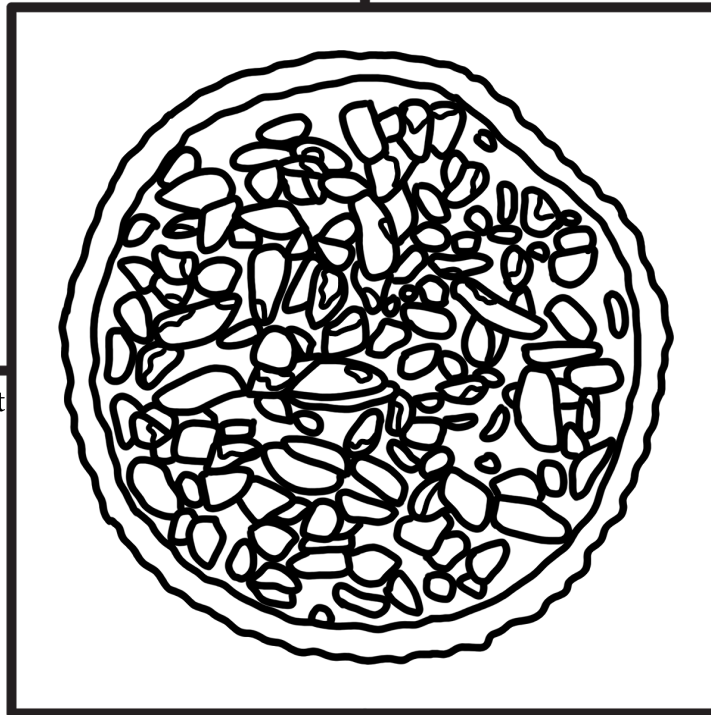

How is it made, and what are its main ingredients?

Is it served by itself or with something else (if so, what)?

Christmas Foods Around the World

Buche-de-noel

In what country/countries is it part of Christmas?

How is it part of Christmas traditions?

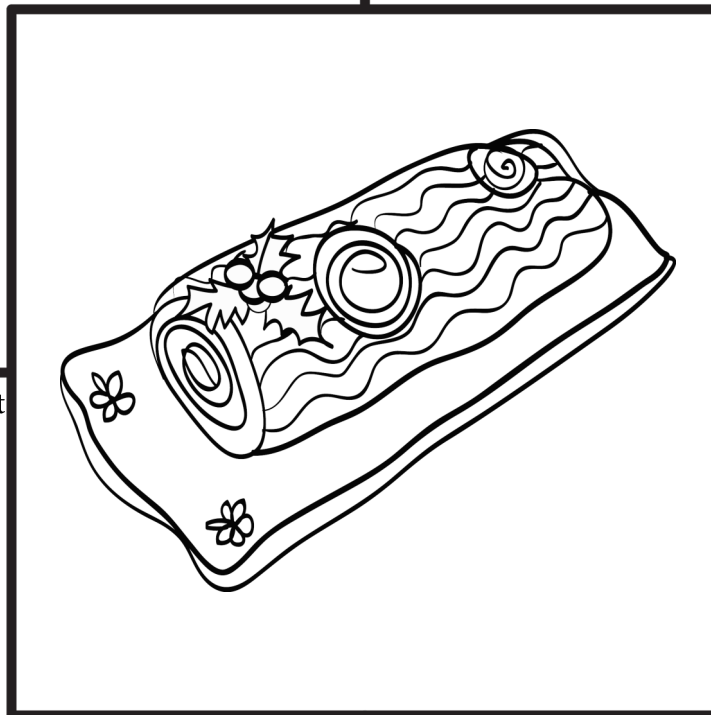

How is it made, and what are its main ingredients?

Is it served by itself or with something else (if so, what)?

Christmas Foods Around the World

Buñuelos

In what country/countries is it part of Christmas?

How is it part of Christmas traditions?

How is it made, and what are its main ingredients?

Is it served by itself or with something else (if so, what)?

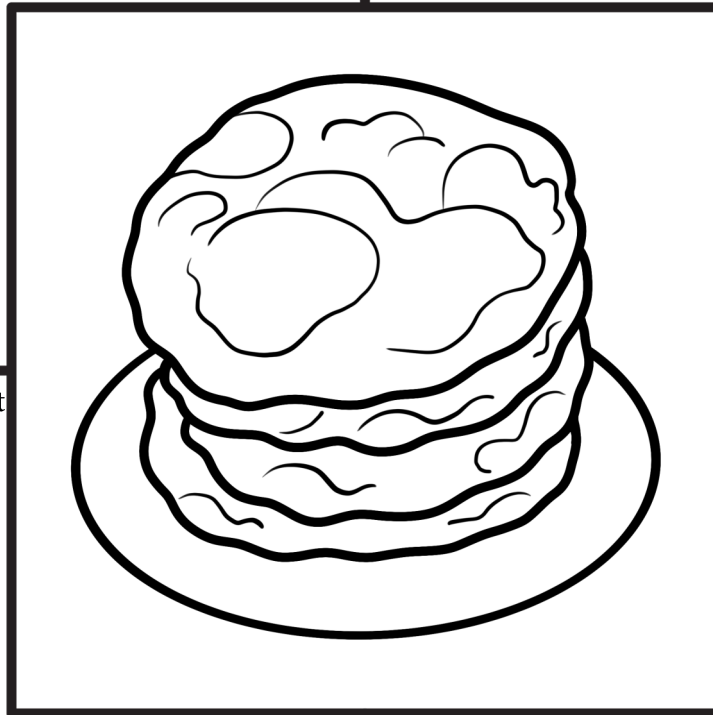

Christmas Foods Around the World

Chicken Bones

In what country/countries is it part of Christmas?

How is it part of Christmas traditions?

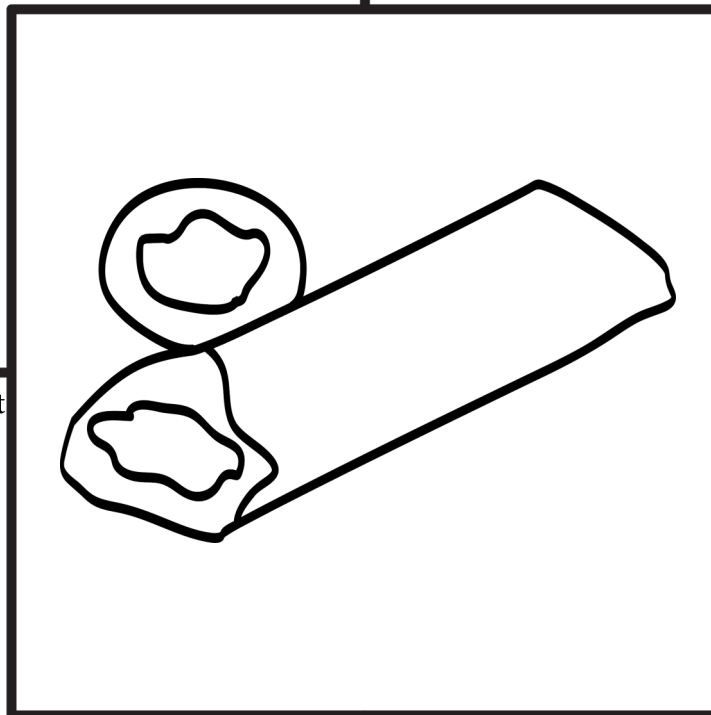

How is it made, and what are its main ingredients?

Is it served by itself or with something else (if so, what)?

Christmas Foods Around the World

Churros

In what country/countries is it part of Christmas?

How is it part of Christmas traditions?

How is it made, and what are its main ingredients?

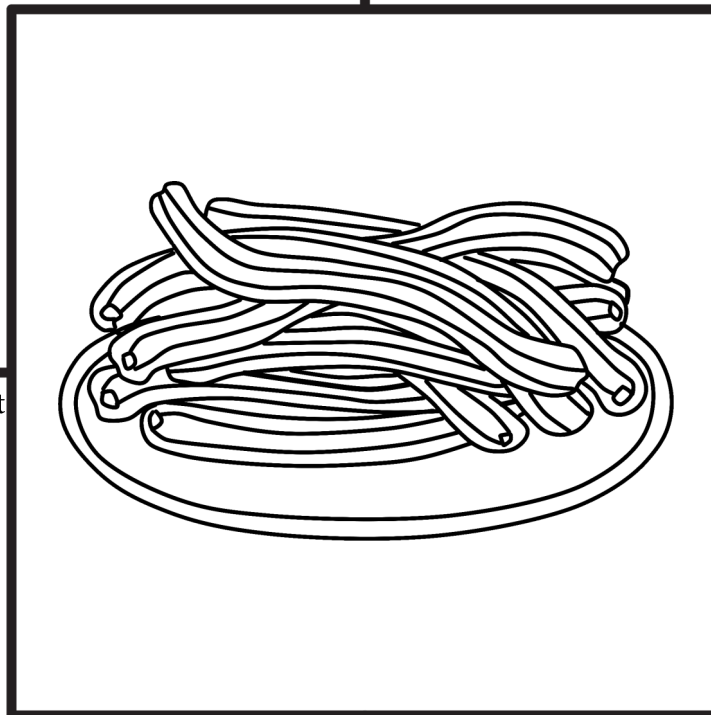

Is it served by itself or with something else (if so, what)?

Christmas Foods Around the World

Conchas

In what country/countries is it part of Christmas?

How is it part of Christmas traditions?

How is it made, and what are its main ingredients?

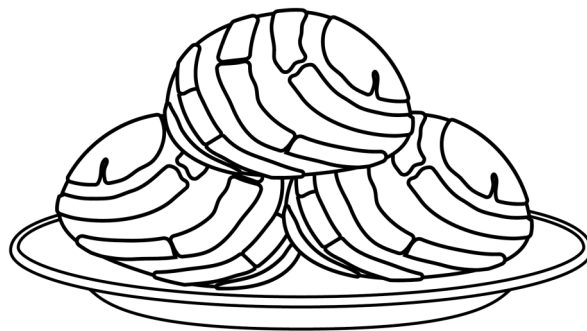

Is it served by itself or with something else (if so, what)?

Christmas Foods Around the World

Doro Wat

In what country/countries is it part of Christmas?

How is it part of Christmas traditions?

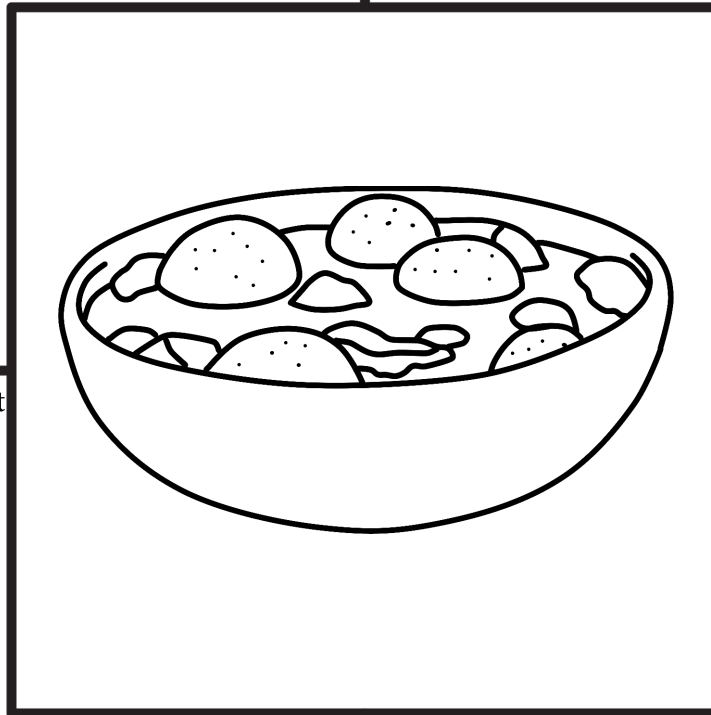

How is it made, and what are its main ingredients?

Is it served by itself or with something else (if so, what)?

Christmas Foods Around the World

Eight Treasures Duck

In what country/countries is it part of Christmas?

How is it part of Christmas traditions?

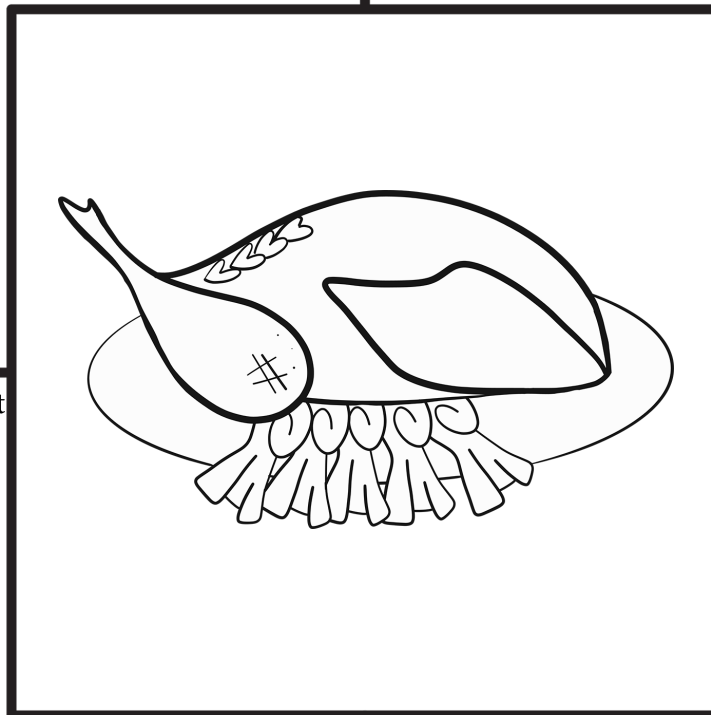

How is it made, and what are its main ingredients?

Is it served by itself or with something else (if so, what)?

Christmas Foods Around the World

Embutido

In what country/countries is it part of Christmas?

How is it part of Christmas traditions?

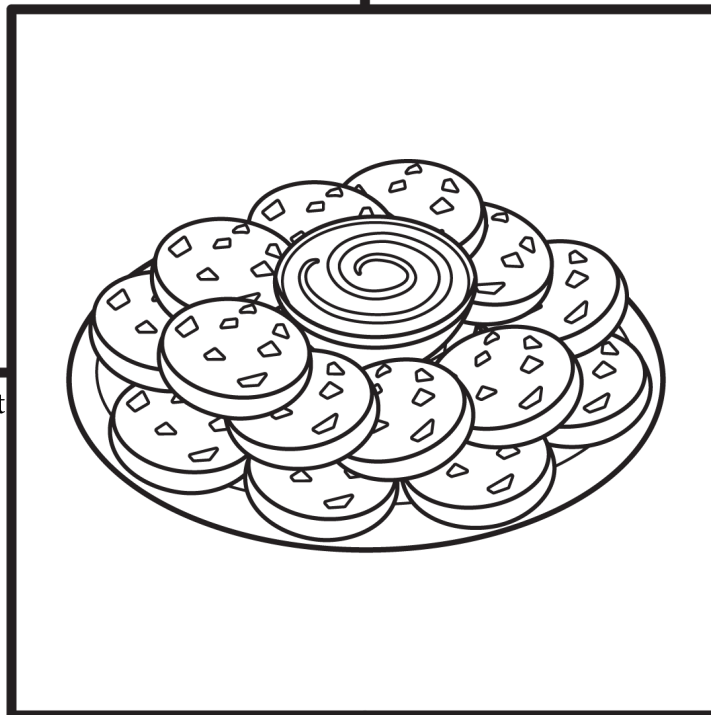

How is it made, and what are its main ingredients?

Is it served by itself or with something else (if so, what)?

Christmas Foods Around the World

Ensalada Nochebuena

In what country/countries is it part of Christmas?

How is it part of Christmas traditions?

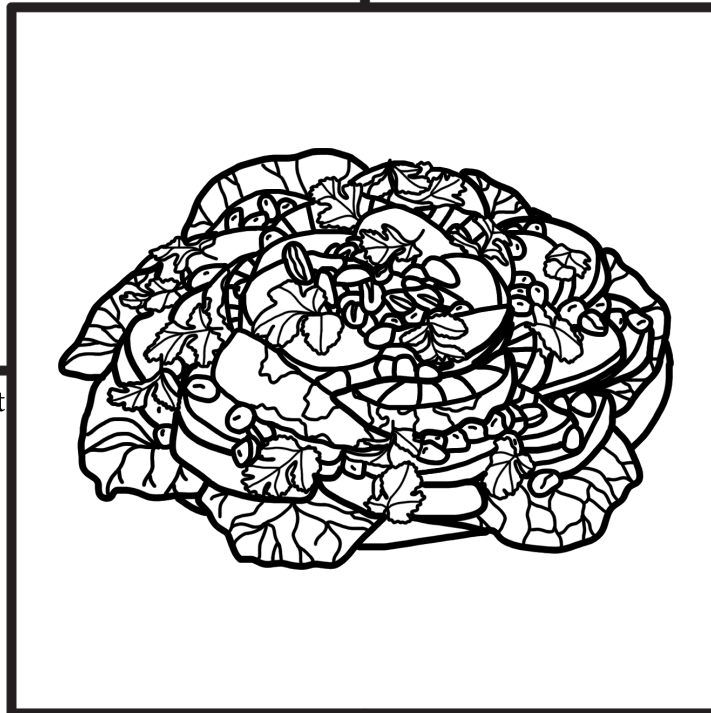

How is it made, and what are its main ingredients?

Is it served by itself or with something else (if so, what)?

Christmas Foods Around the World

Escargot

In what country/countries is it part of Christmas?

How is it part of Christmas traditions?

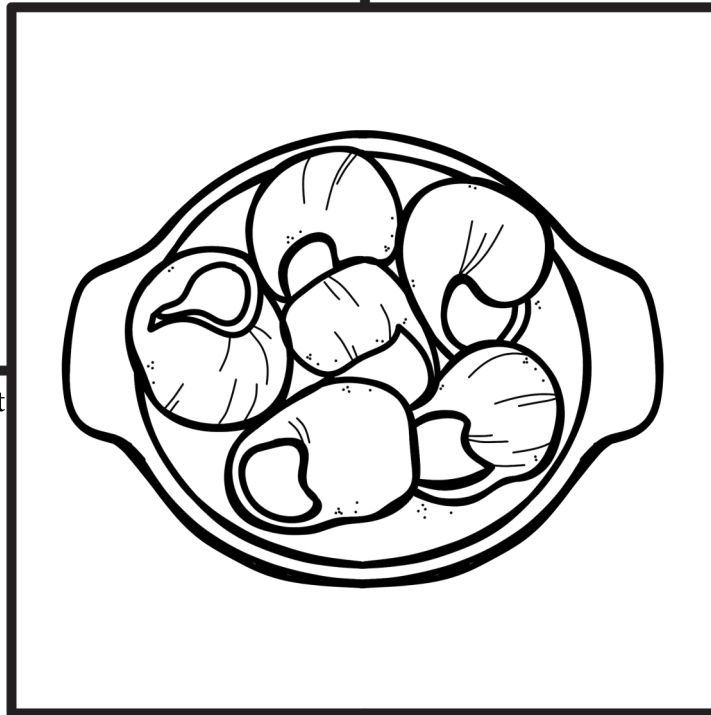

How is it made, and what are its main ingredients?

Is it served by itself or with something else (if so, what)?

Christmas Foods Around the World

Fata

In what country/countries is it part of Christmas?

How is it part of Christmas traditions?

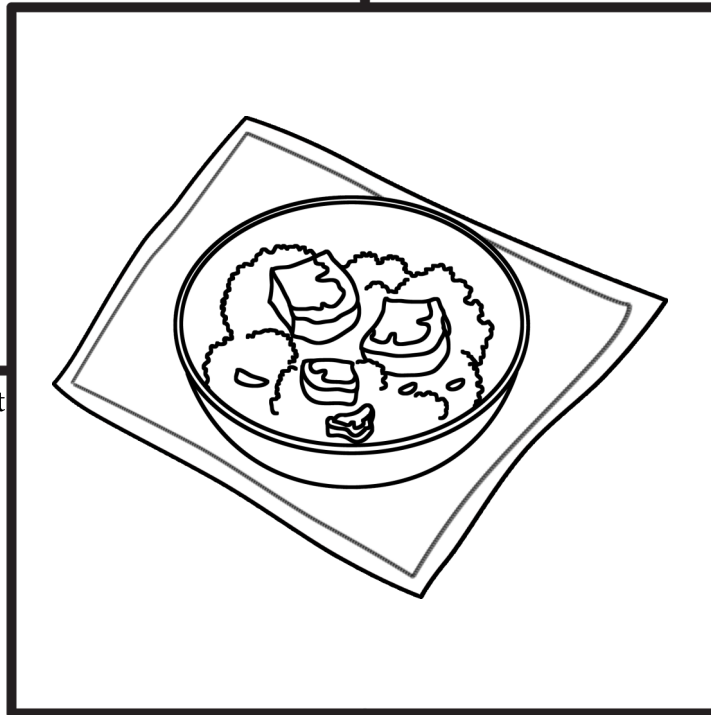

How is it made, and what are its main ingredients?

Is it served by itself or with something else (if so, what)?

Christmas Foods Around the World

Foie Gras

In what country/countries is it part of Christmas?

How is it part of Christmas traditions?

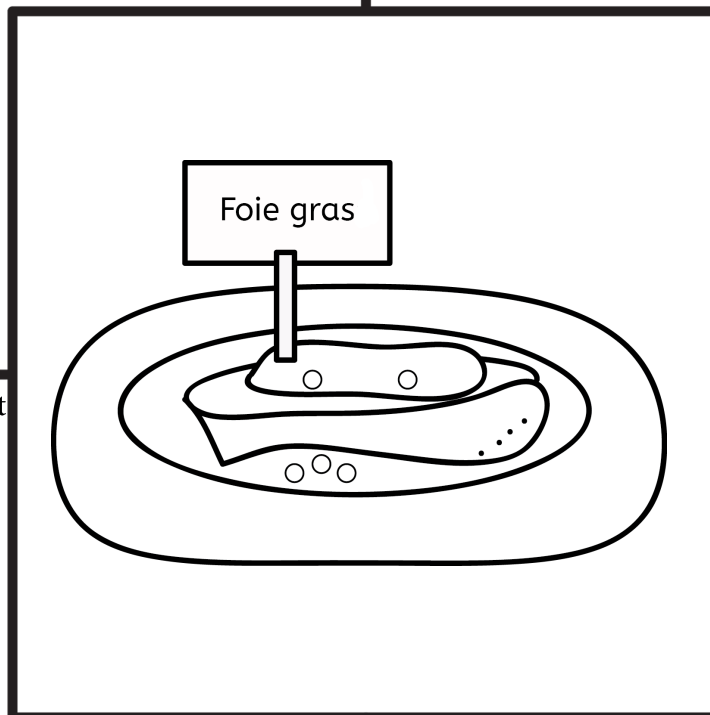

How is it made, and what are its main ingredients?

Is it served by itself or with something else (if so, what)?

Christmas Foods Around the World

Fondue

In what country/countries is it part of Christmas?

How is it part of Christmas traditions?

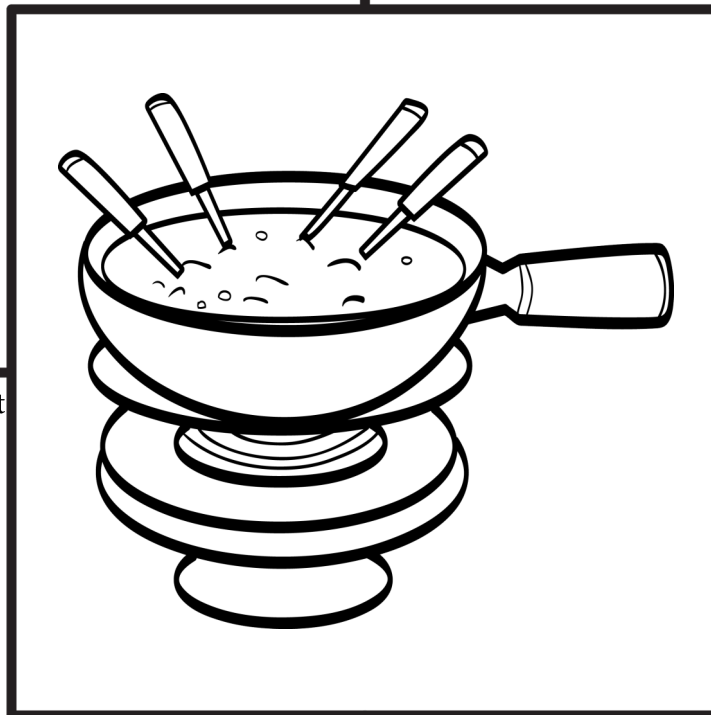

How is it made, and what are its main ingredients?

Is it served by itself or with something else (if so, what)?

Christmas Foods Around the World

Fried Chicken

In what country/countries is it part of Christmas?

How is it part of Christmas traditions?

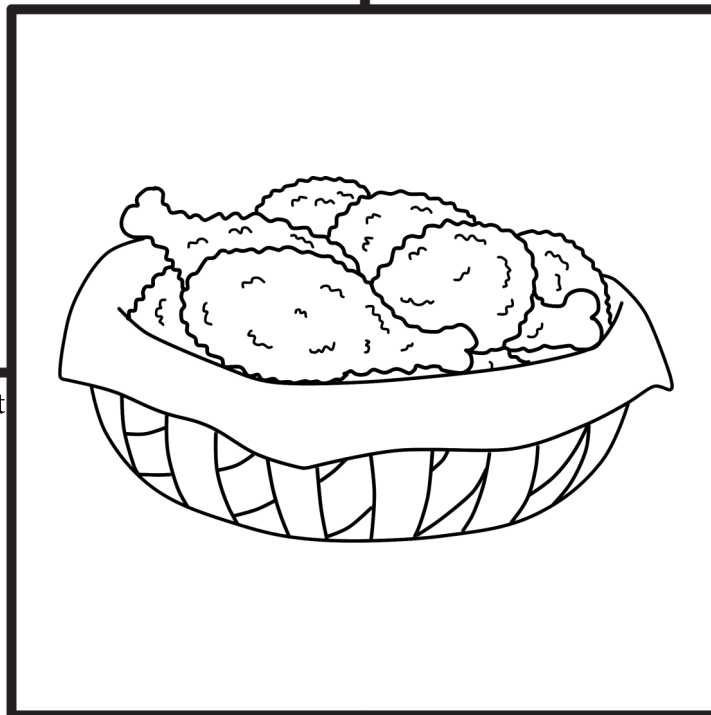

How is it made, and what are its main ingredients?

Is it served by itself or with something else (if so, what)?

Christmas Foods Around the World

Frumenty

In what country/countries is it part of Christmas?

How is it part of Christmas traditions?

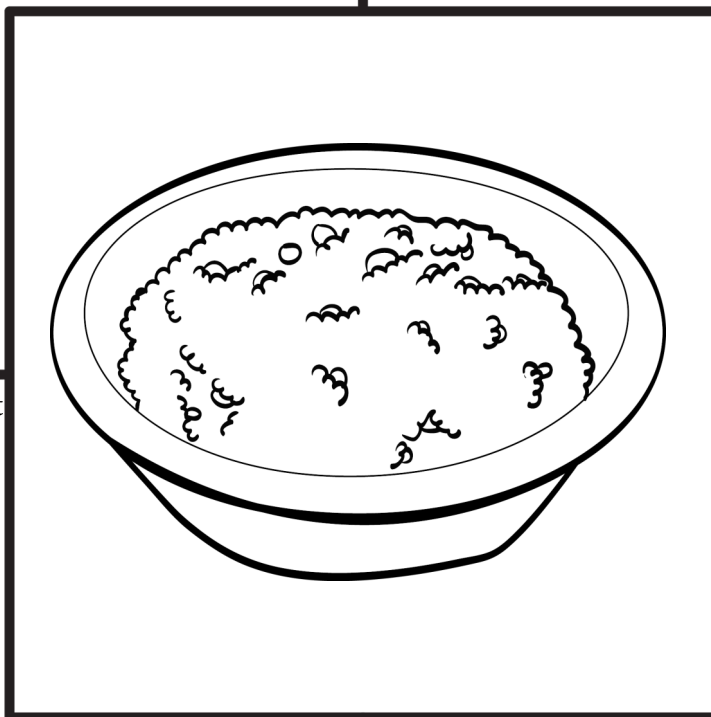

How is it made, and what are its main ingredients?

Is it served by itself or with something else (if so, what)?

Christmas Foods Around the World

Galette des Rois

In what country/countries is it part of Christmas?

How is it part of Christmas traditions?

How is it made, and what are its main ingredients?

Is it served by itself or with something else (if so, what)?

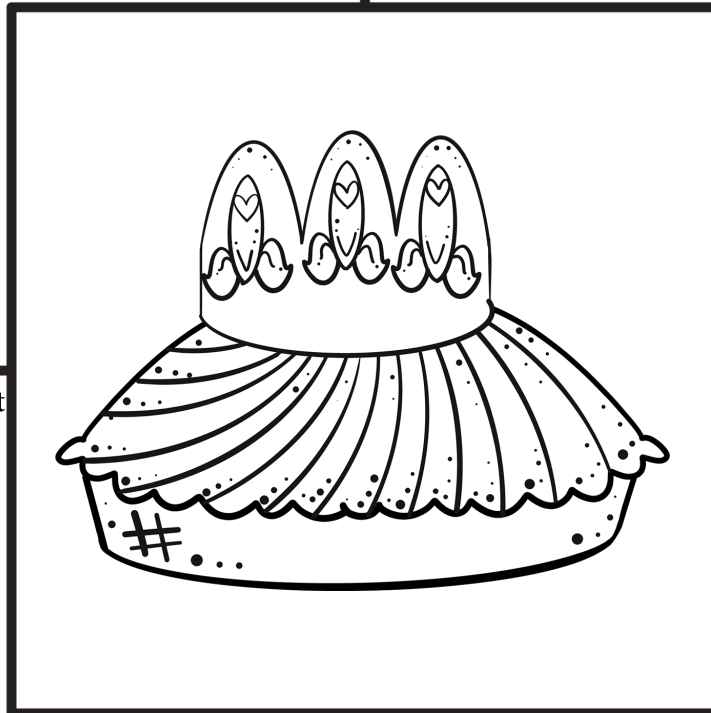

Christmas Foods Around the World

Injera

In what country/countries is it part of Christmas?

How is it part of Christmas traditions?

How is it made, and what are its main ingredients?

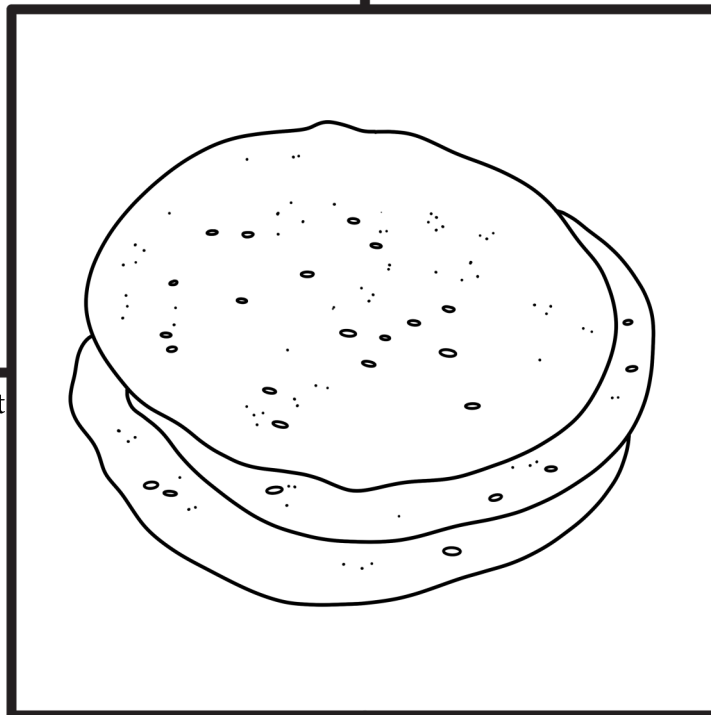

Is it served by itself or with something else (if so, what)?

Christmas Foods Around the World

Julskinka

In what country/countries is it part of Christmas?

How is it part of Christmas traditions?

How is it made, and what are its main ingredients?

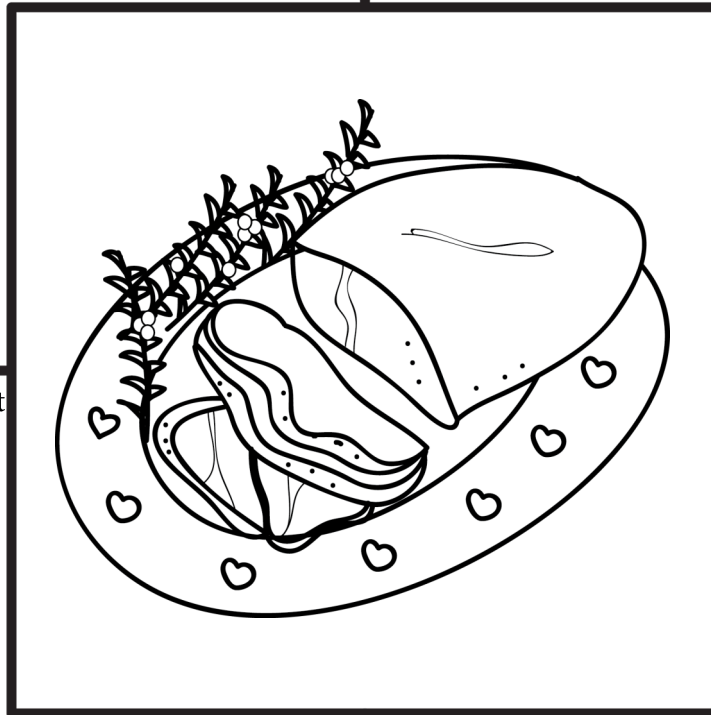

Is it served by itself or with something else (if so, what)?

Christmas Foods Around the World

Kahk

In what country/countries is it part of Christmas?

How is it part of Christmas traditions?

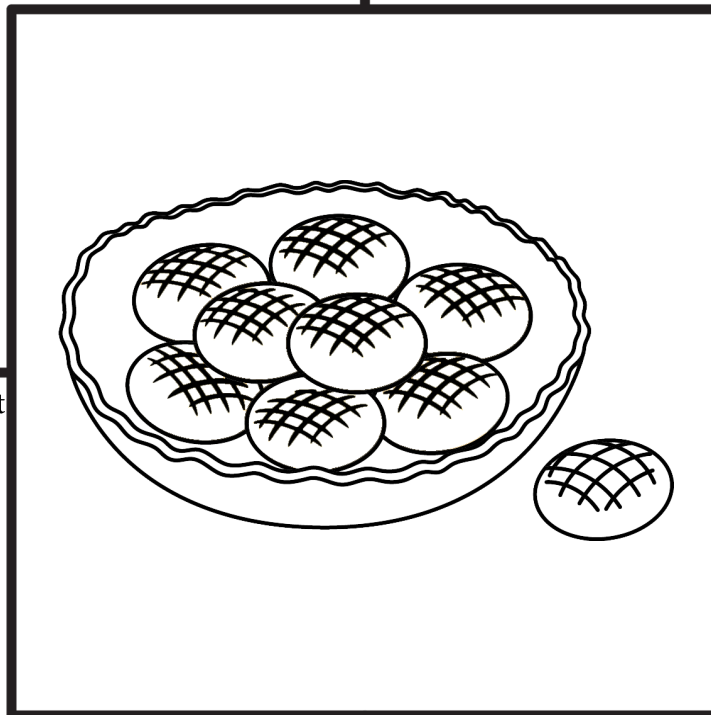

How is it made, and what are its main ingredients?

Is it served by itself or with something else (if so, what)?

Christmas Foods Around the World

Kalamay

In what country/countries is it part of Christmas?

How is it part of Christmas traditions?

How is it made, and what are its main ingredients?

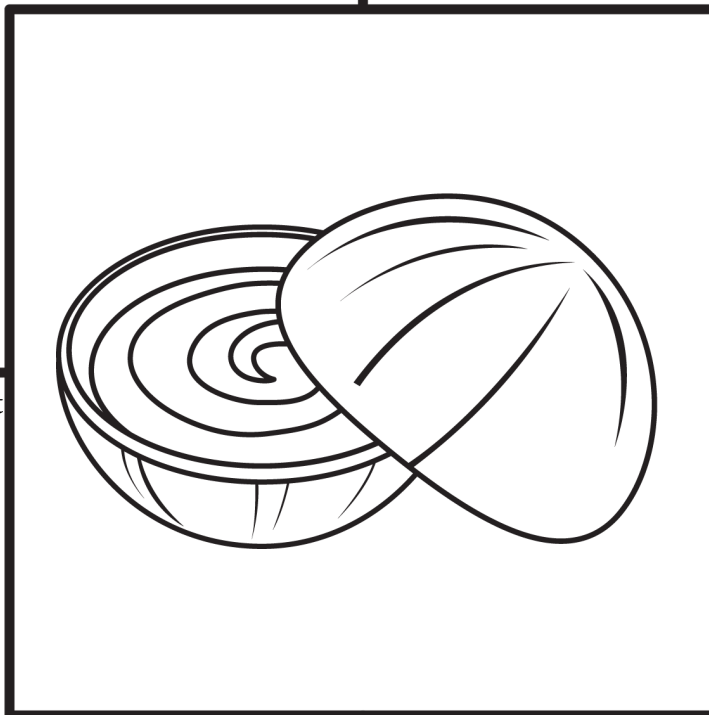

Is it served by itself or with something else (if so, what)?

Christmas Foods Around the World

Kerstol

In what country/countries is it part of Christmas?

How is it part of Christmas traditions?

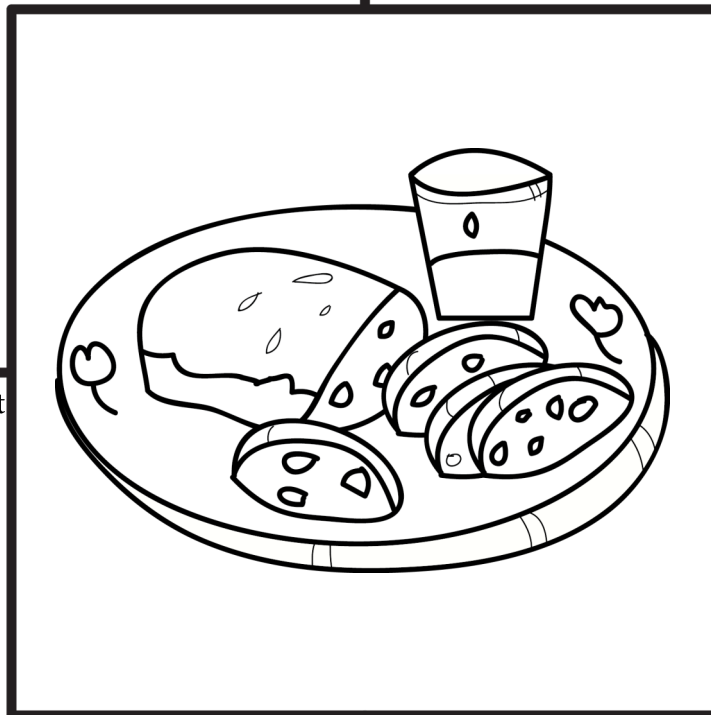

How is it made, and what are its main ingredients?

Is it served by itself or with something else (if so, what)?

Christmas Foods Around the World

Kurisumasu Keki

In what country/countries is it part of Christmas?

How is it part of Christmas traditions?

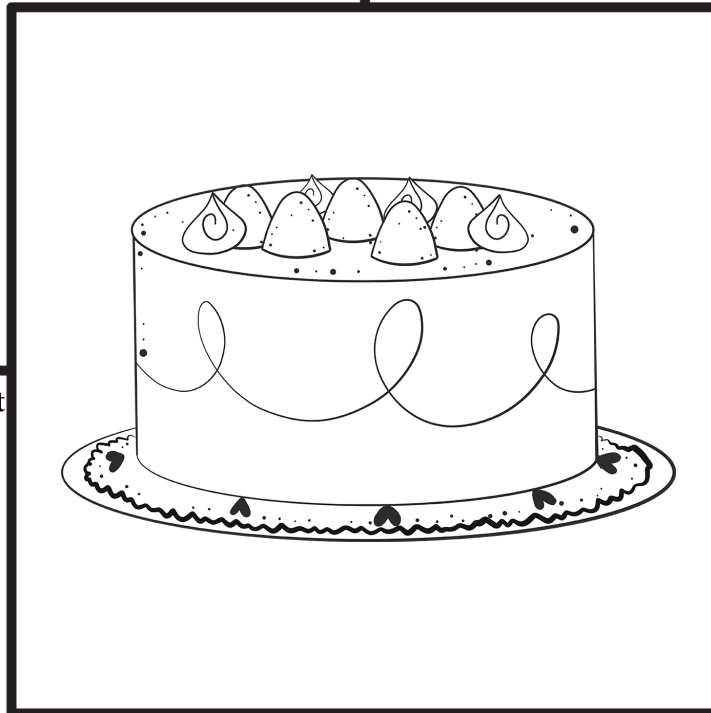

How is it made, and what are its main ingredients?

Is it served by itself or with something else (if so, what)?

Christmas Foods Around the World

Kutya

In what country/countries is it part of Christmas?

How is it part of Christmas traditions?

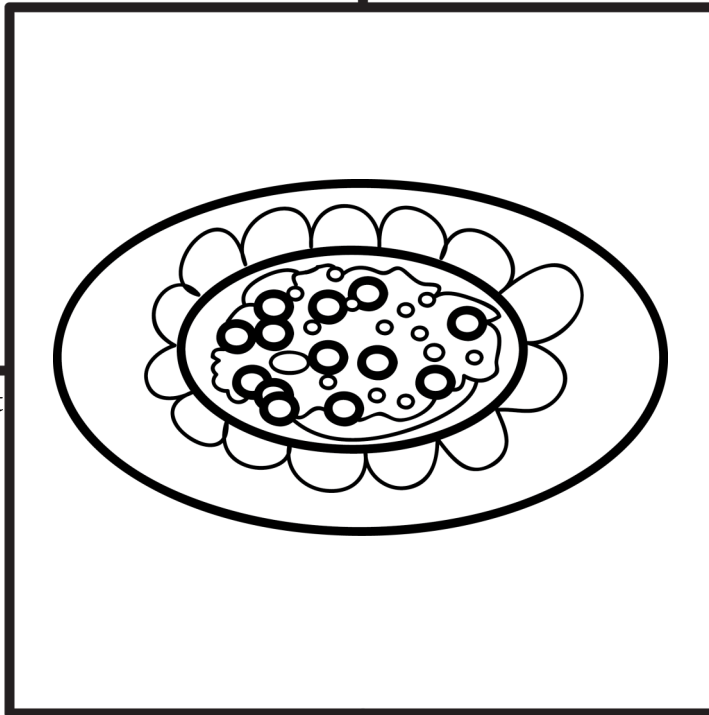

How is it made, and what are its main ingredients?

Is it served by itself or with something else (if so, what)?

Christmas Foods Around the World

Lebkuchen

In what country/countries is it part of Christmas?

How is it part of Christmas traditions?

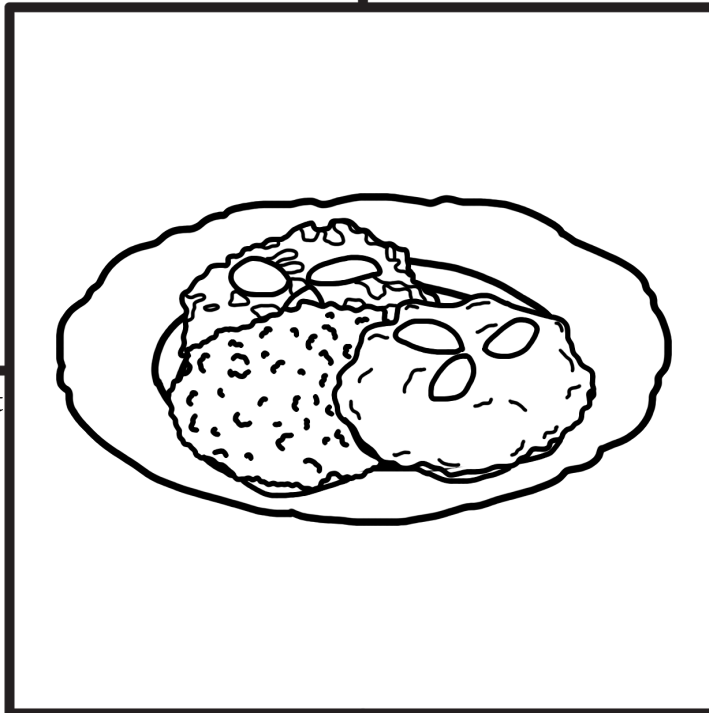

How is it made, and what are its main ingredients?

Is it served by itself or with something else (if so, what)?

Christmas Foods Around the World

Les Huîtres

In what country/countries is it part of Christmas?

How is it part of Christmas traditions?

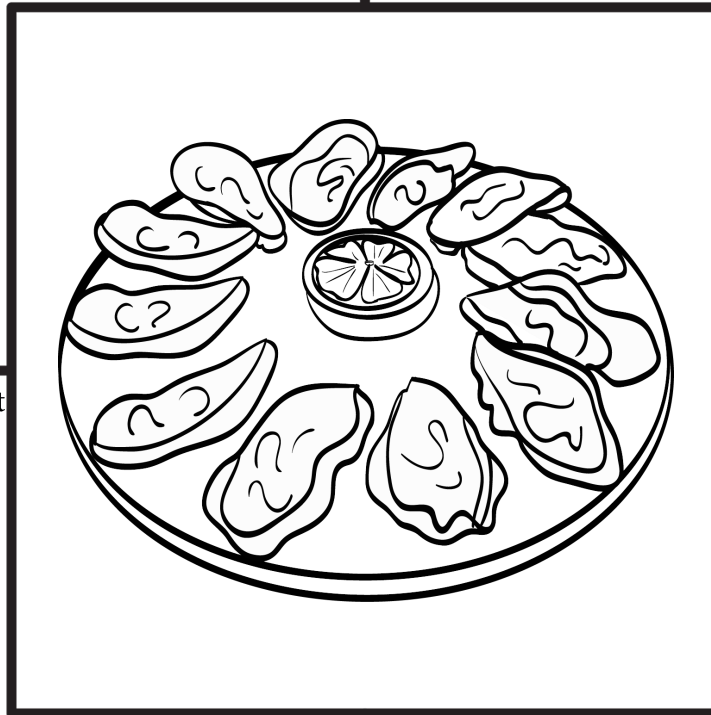

How is it made, and what are its main ingredients?

Is it served by itself or with something else (if so, what)?

Christmas Foods Around the World

Lussekatts

In what country/countries is it part of Christmas?

How is it part of Christmas traditions?

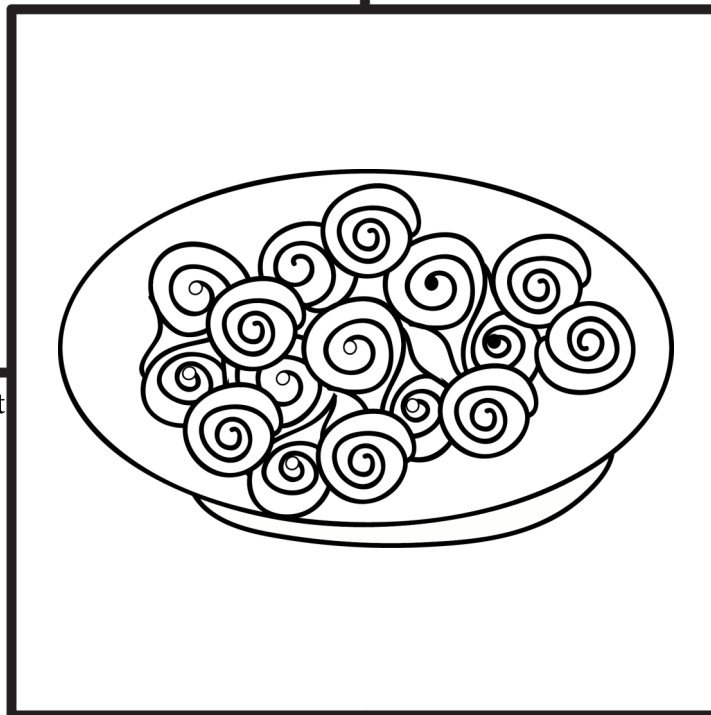

How is it made, and what are its main ingredients?

Is it served by itself or with something else (if so, what)?

Christmas Foods Around the World

Malva Pudding

In what country/countries is it part of Christmas?

How is it part of Christmas traditions?

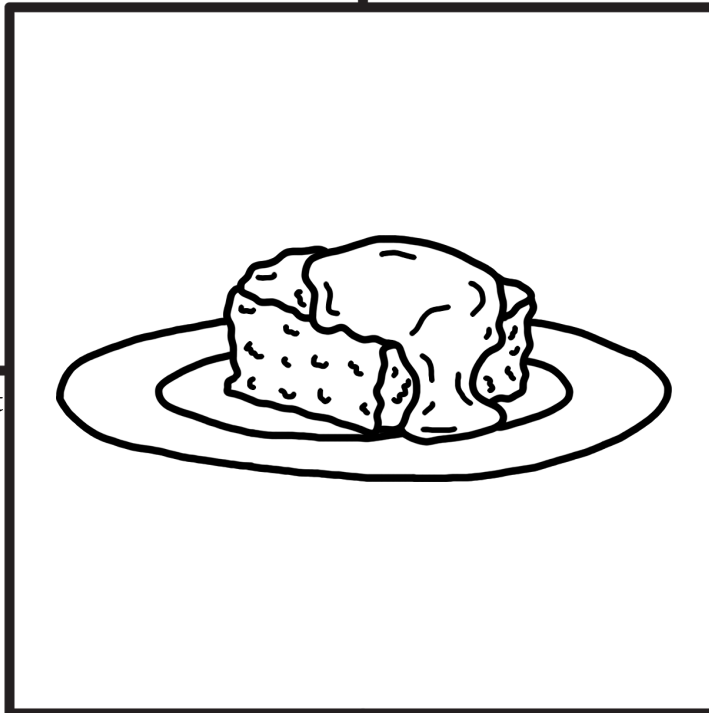

How is it made, and what are its main ingredients?

Is it served by itself or with something else (if so, what)?

Christmas Foods Around the World

Marisco

In what country/countries is it part of Christmas?

How is it part of Christmas traditions?

How is it made, and what are its main ingredients?

Is it served by itself or with something else (if so, what)?

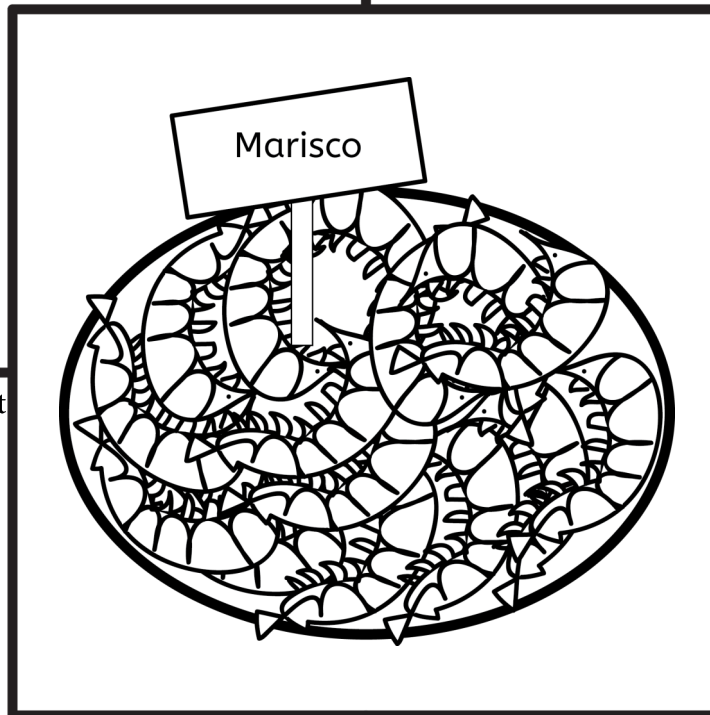

Christmas Foods Around the World

Marzipankartoffeln

In what country/countries is it part of Christmas?

How is it part of Christmas traditions?

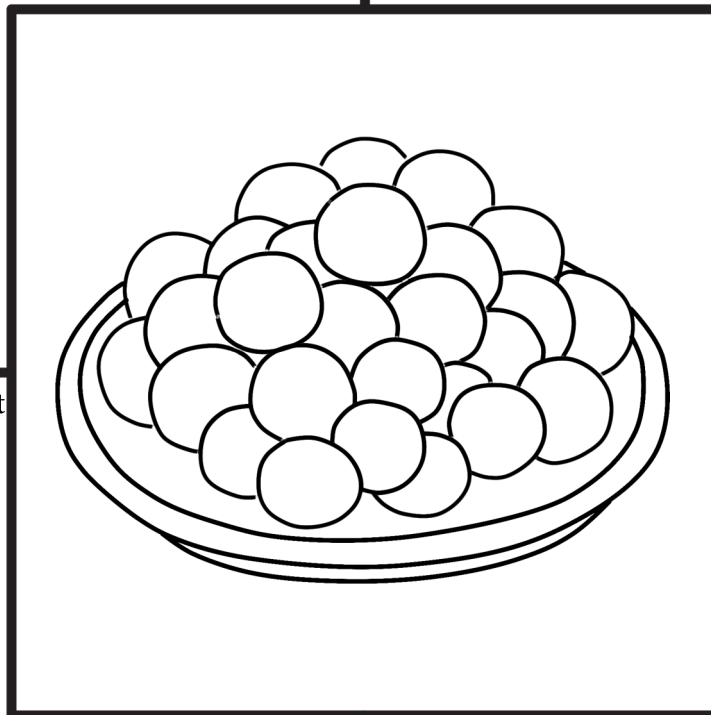

How is it made, and what are its main ingredients?

Is it served by itself or with something else (if so, what)?

Christmas Foods Around the World

Nougat

In what country/countries is it part of Christmas?

How is it part of Christmas traditions?

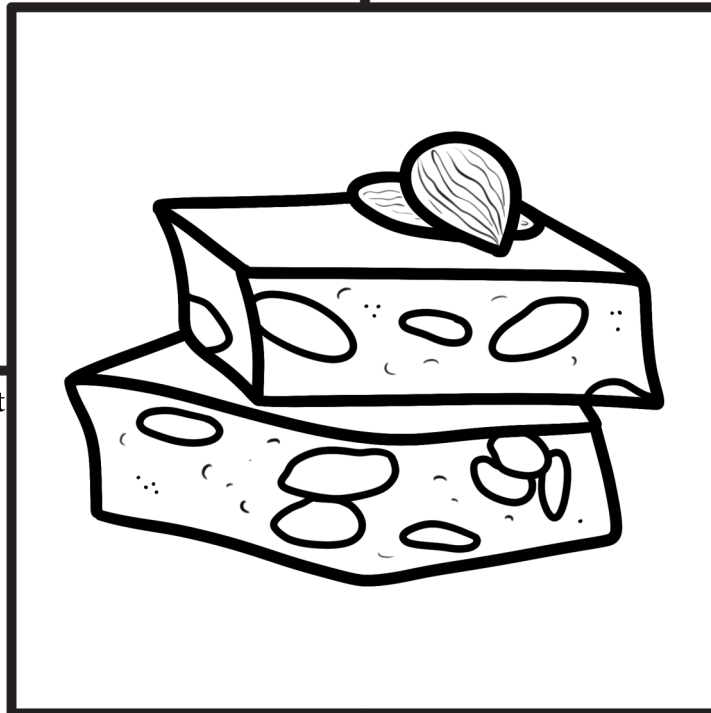

How is it made, and what are its main ingredients?

Is it served by itself or with something else (if so, what)?

Christmas Foods Around the World

Nyama Choma

In what country/countries is it part of Christmas?

How is it part of Christmas traditions?

How is it made, and what are its main ingredients?

Is it served by itself or with something else (if so, what)?

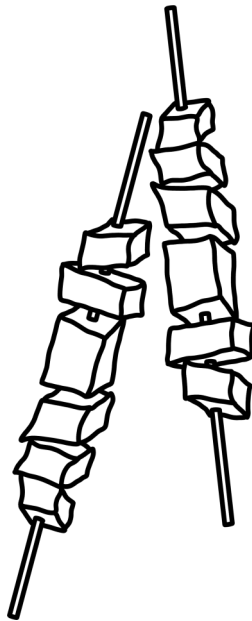

Christmas Foods Around the World

Oliebollen

In what country/countries is it part of Christmas?

How is it part of Christmas traditions?

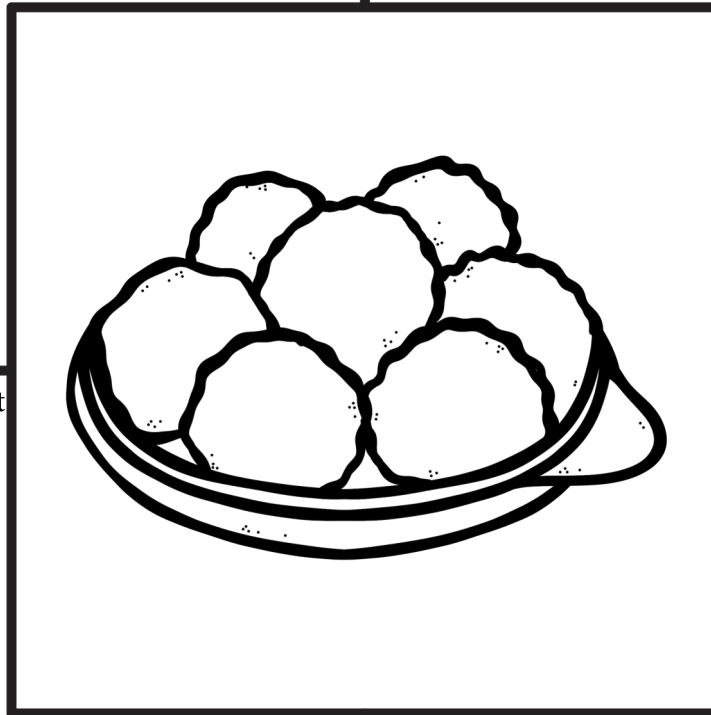

How is it made, and what are its main ingredients?

Is it served by itself or with something else (if so, what)?

Christmas Foods Around the World

Pagach

In what country/countries is it part of Christmas?

How is it part of Christmas traditions?

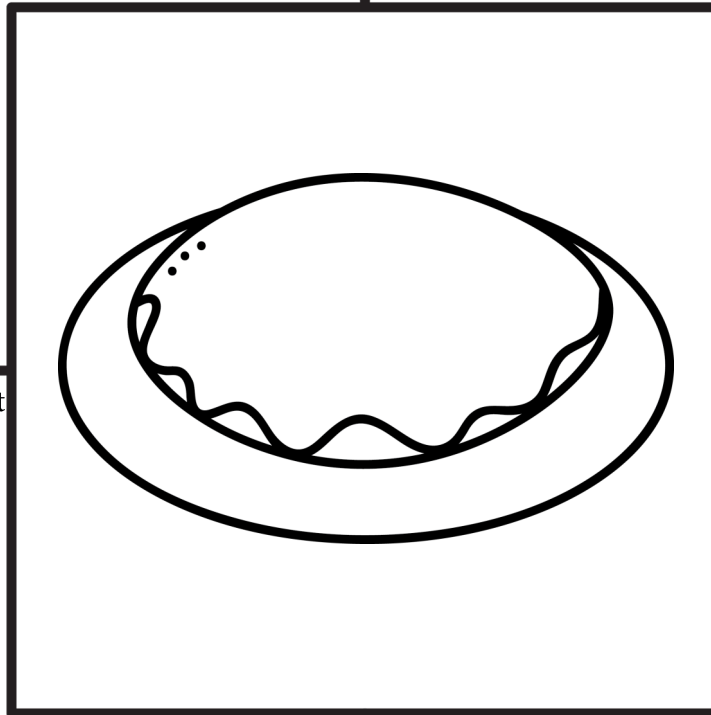

How is it made, and what are its main ingredients?

Is it served by itself or with something else (if so, what)?

Christmas Foods Around the World

Pancit

In what country/countries is it part of Christmas?

How is it part of Christmas traditions?

How is it made, and what are its main ingredients?

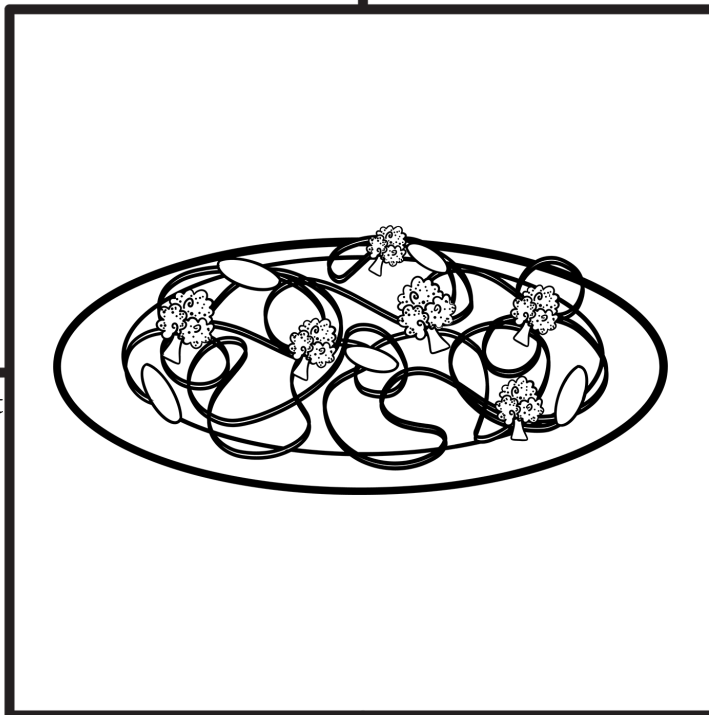

Is it served by itself or with something else (if so, what)?

Christmas Foods Around the World

Pandesal

In what country/countries is it part of Christmas?

How is it part of Christmas traditions?

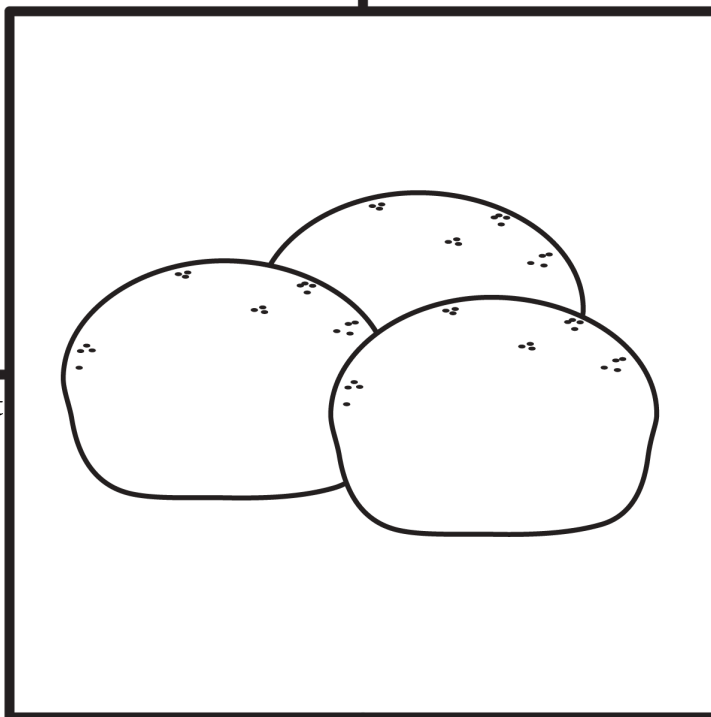

How is it made, and what are its main ingredients?

Is it served by itself or with something else (if so, what)?

Christmas Foods Around the World

Pandoro

In what country/countries is it part of Christmas?

How is it part of Christmas traditions?

How is it made, and what are its main ingredients?

Is it served by itself or with something else (if so, what)?

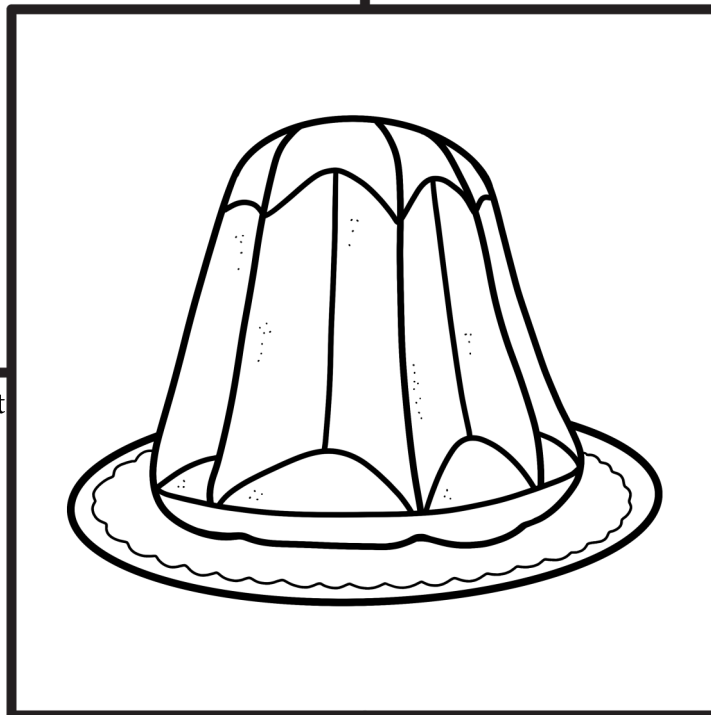

Christmas Foods Around the World

Panettone

In what country/countries is it part of Christmas?

How is it part of Christmas traditions?

How is it made, and what are its main ingredients?

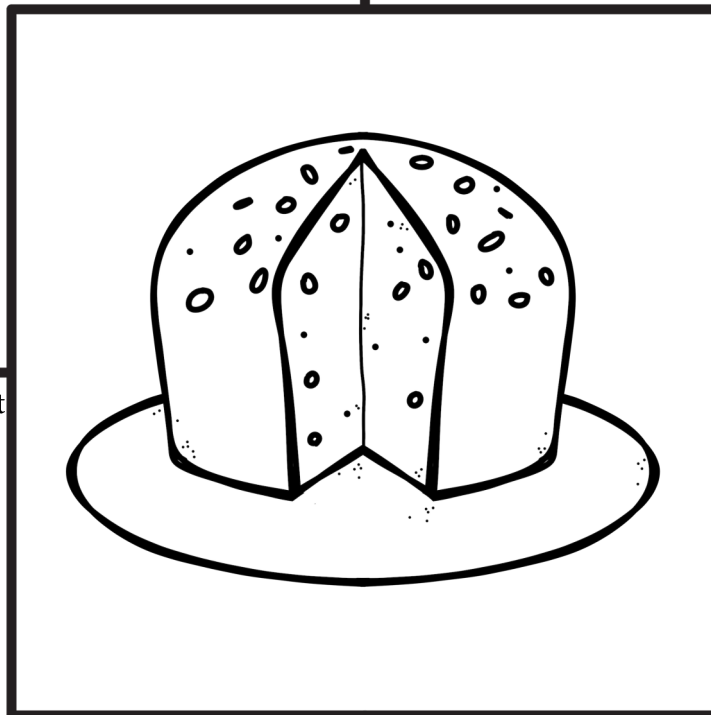

Is it served by itself or with something else (if so, what)?

Christmas Foods Around the World

Panforte

In what country/countries is it part of Christmas?

How is it part of Christmas traditions?

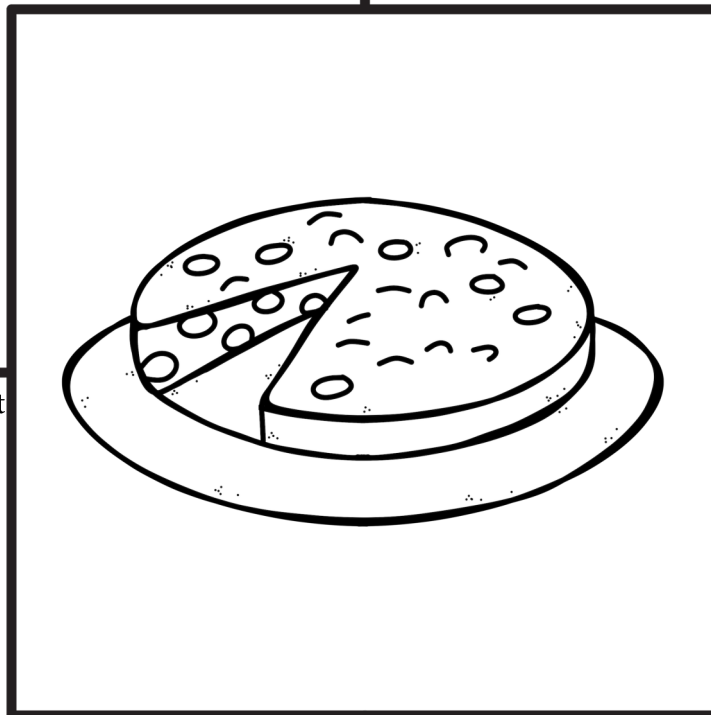

How is it made, and what are its main ingredients?

Is it served by itself or with something else (if so, what)?

Christmas Foods Around the World

Panpepato

In what country/countries is it part of Christmas?

How is it part of Christmas traditions?

How is it made, and what are its main ingredients?

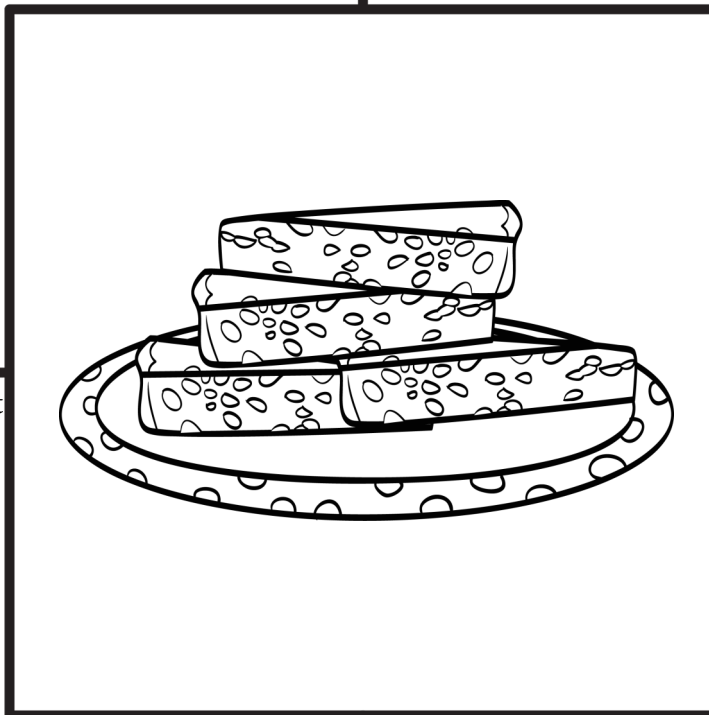

Is it served by itself or with something else (if so, what)?

Christmas Foods Around the World

Pave

In what country/countries is it part of Christmas?

How is it part of Christmas traditions?

How is it made, and what are its main ingredients?

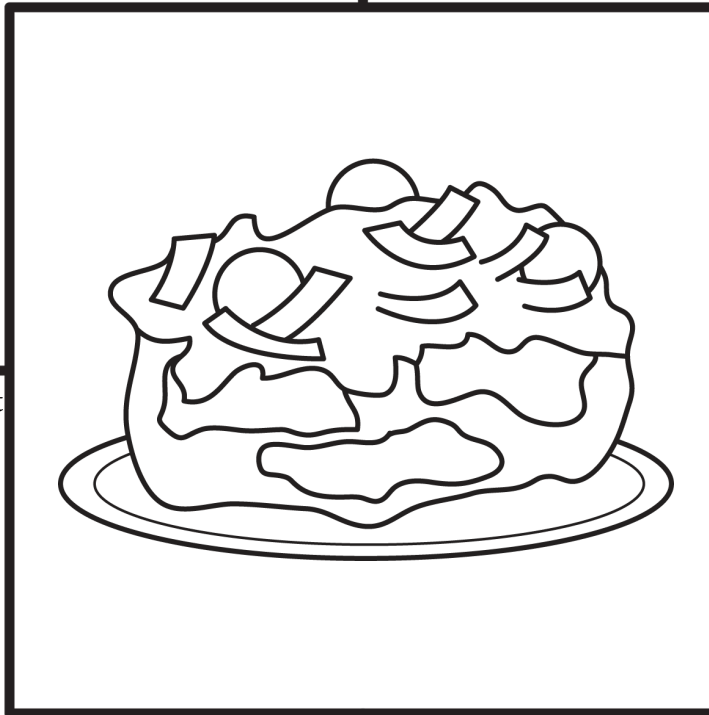

Is it served by itself or with something else (if so, what)?

Christmas Foods Around the World

Pavlova

In what country/countries is it part of Christmas?

How is it part of Christmas traditions?

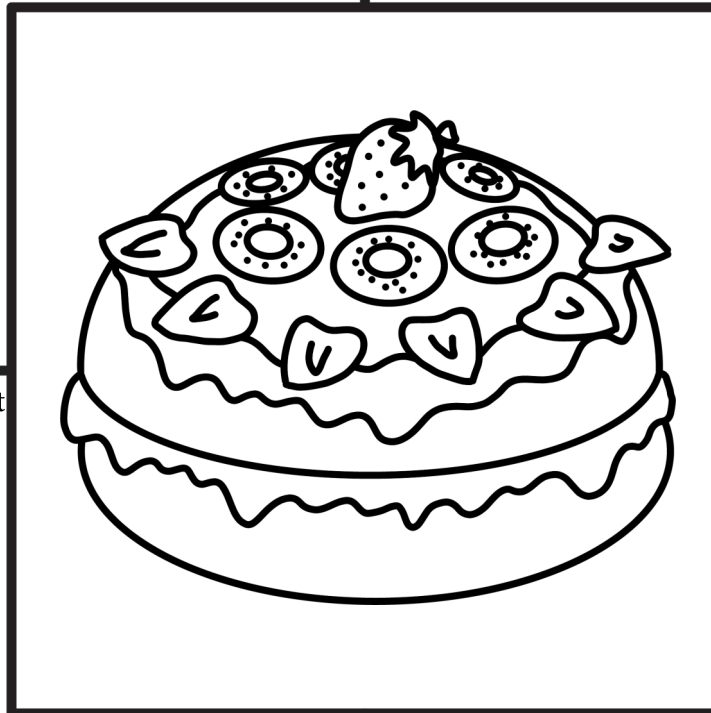

How is it made, and what are its main ingredients?

Is it served by itself or with something else (if so, what)?

Christmas Foods Around the World

Pavo Trufado de Navidad

In what country/countries is it part of Christmas?

How is it part of Christmas traditions?

How is it made, and what are its main ingredients?

Is it served by itself or with something else (if so, what)?

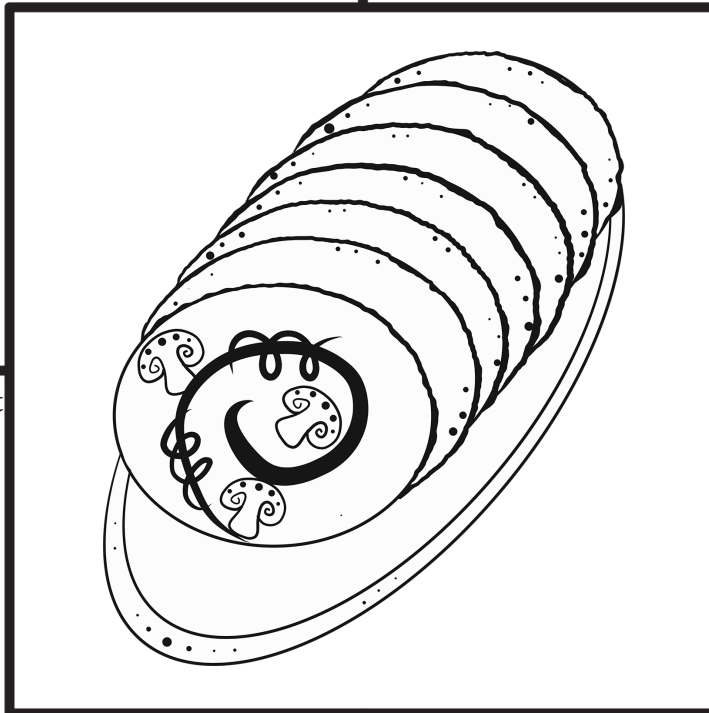

Christmas Foods Around the World

Pelmeni

In what country/countries is it part of Christmas?

How is it part of Christmas traditions?

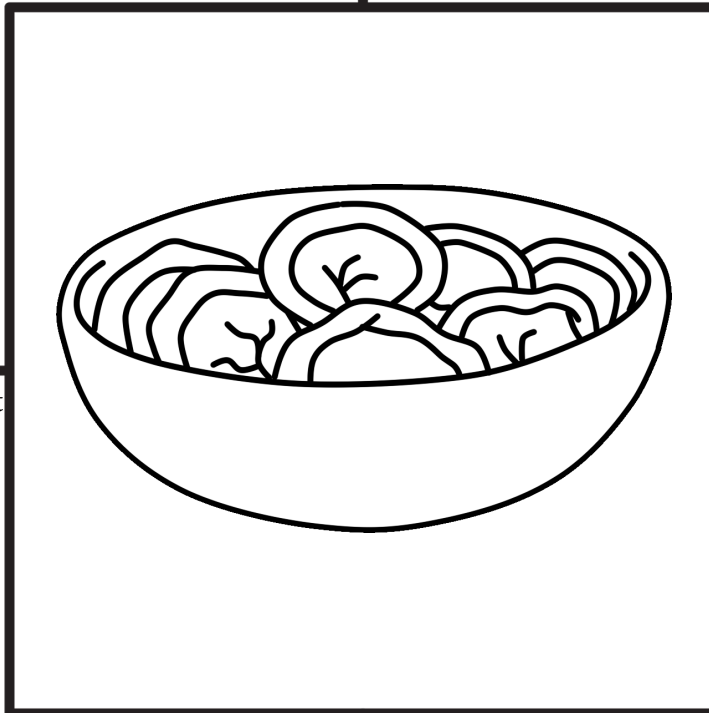

How is it made, and what are its main ingredients?

Is it served by itself or with something else (if so, what)?

Christmas Foods Around the World

Pepernoot

In what country/countries is it part of Christmas?

How is it part of Christmas traditions?

How is it made, and what are its main ingredients?

Is it served by itself or with something else (if so, what)?

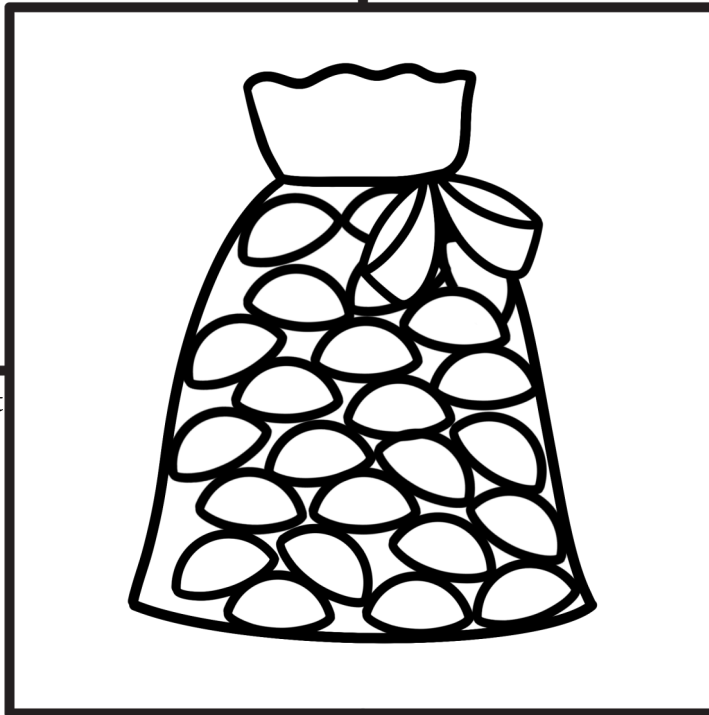

Christmas Foods Around the World

Pepparkakor

In what country/countries is it part of Christmas?

How is it part of Christmas traditions?

How is it made, and what are its main ingredients?

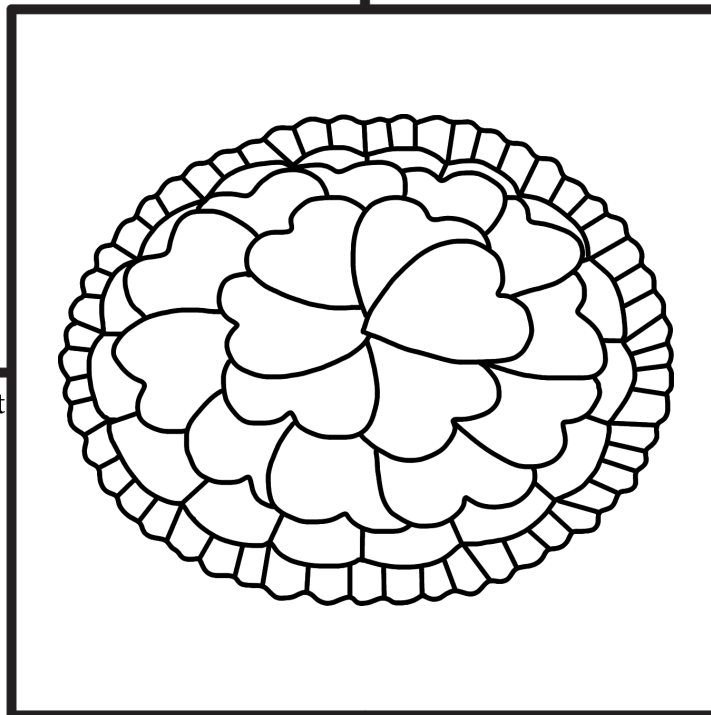

Is it served by itself or with something else (if so, what)?

Christmas Foods Around the World

Plum Pudding

In what country/countries is it part of Christmas?

How is it part of Christmas traditions?

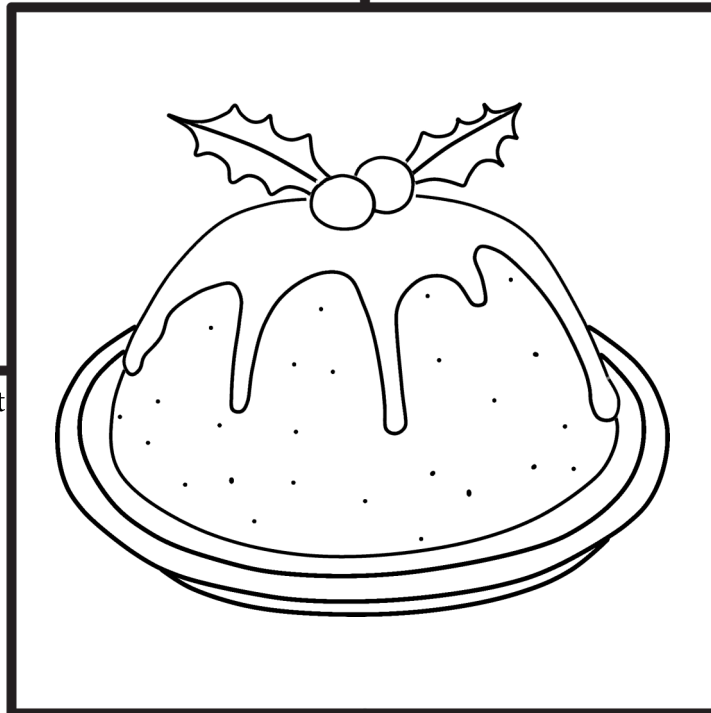

How is it made, and what are its main ingredients?

Is it served by itself or with something else (if so, what)?

Christmas Foods Around the World

Ponche

In what country/countries is it part of Christmas?

How is it part of Christmas traditions?

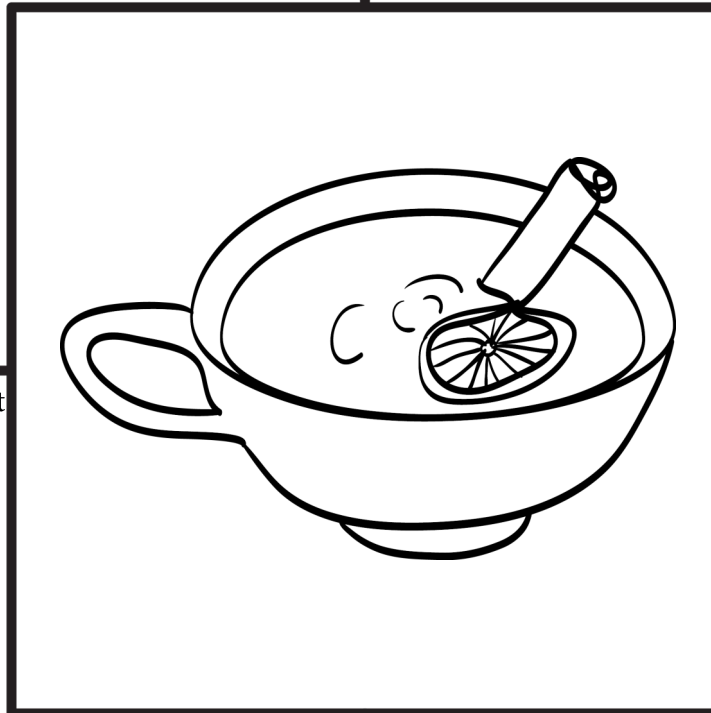

How is it made, and what are its main ingredients?

Is it served by itself or with something else (if so, what)?

Christmas Foods Around the World

Pozole

In what country/countries is it part of Christmas?

How is it part of Christmas traditions?

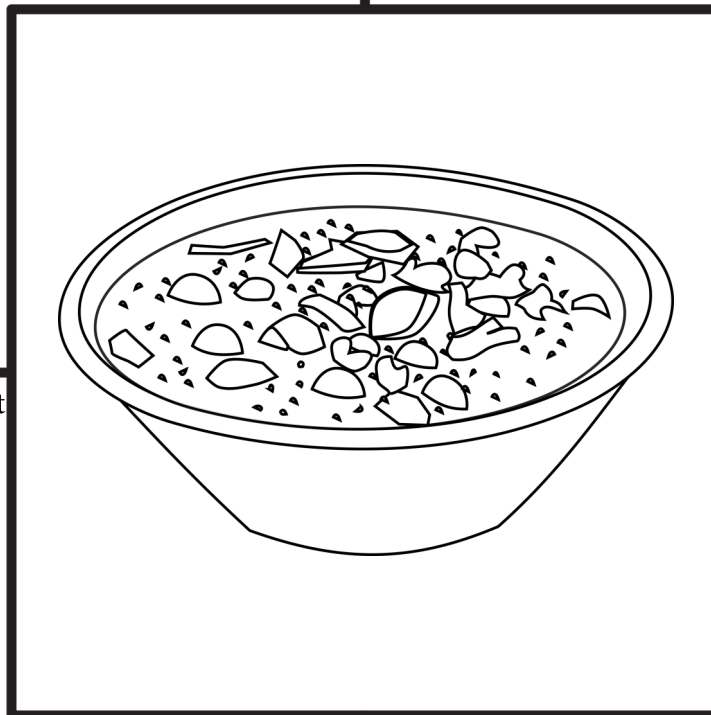

How is it made, and what are its main ingredients?

Is it served by itself or with something else (if so, what)?

Christmas Foods Around the World

Puto Bumbong

In what country/countries is it part of Christmas?

How is it part of Christmas traditions?

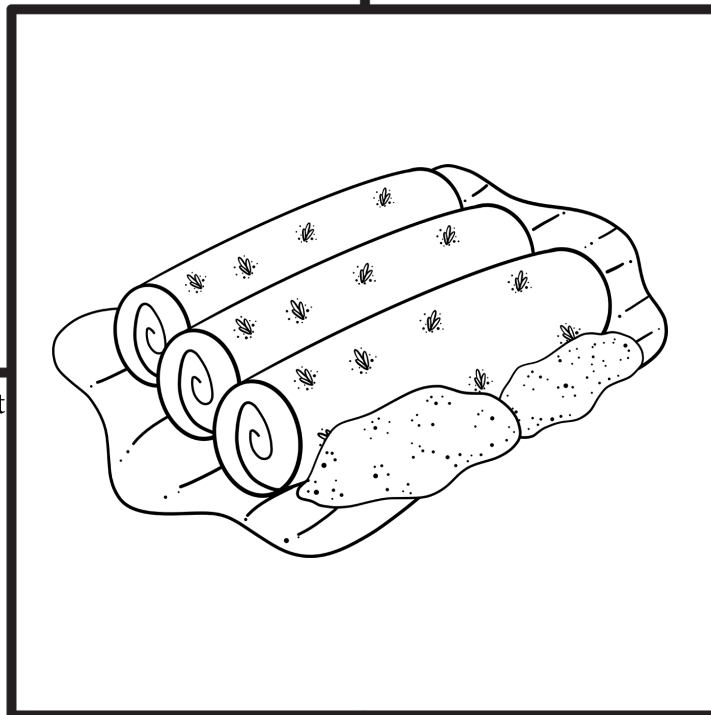

How is it made, and what are its main ingredients?

Is it served by itself or with something else (if so, what)?

Christmas Foods Around the World

Rabanada

In what country/countries is it part of Christmas?

How is it part of Christmas traditions?

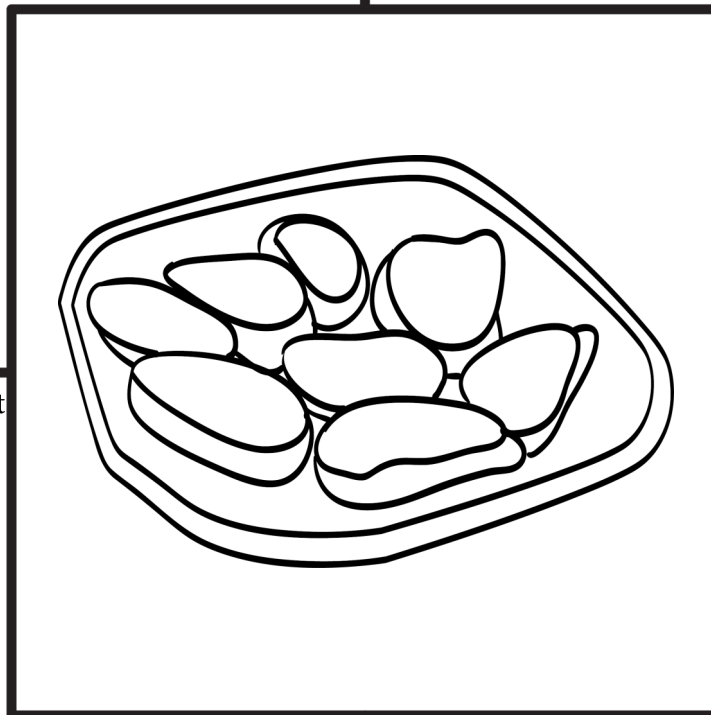

How is it made, and what are its main ingredients?

Is it served by itself or with something else (if so, what)?

Christmas Foods Around the World

Raclette

In what country/countries is it part of Christmas?

How is it part of Christmas traditions?

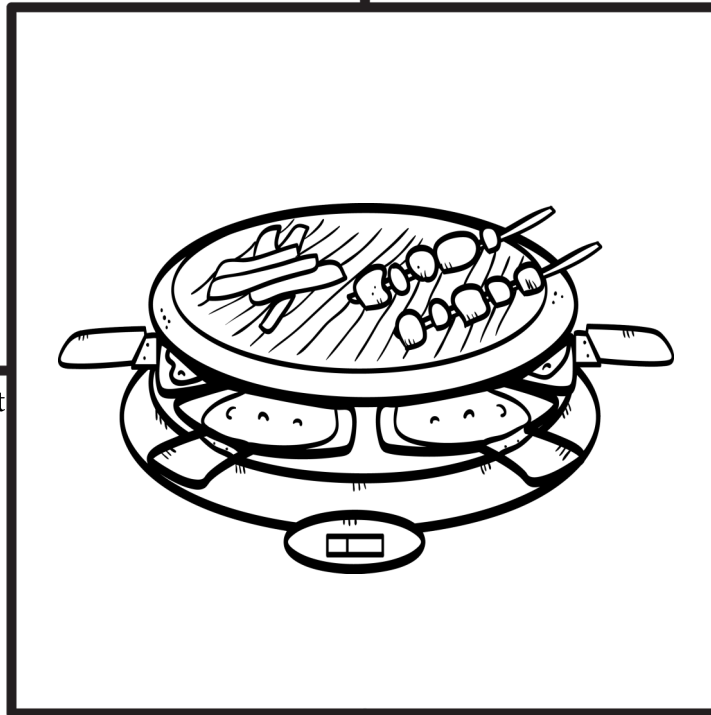

How is it made, and what are its main ingredients?

Is it served by itself or with something else (if so, what)?

Christmas Foods Around the World

Risgryngrot

In what country/countries is it part of Christmas?

How is it part of Christmas traditions?

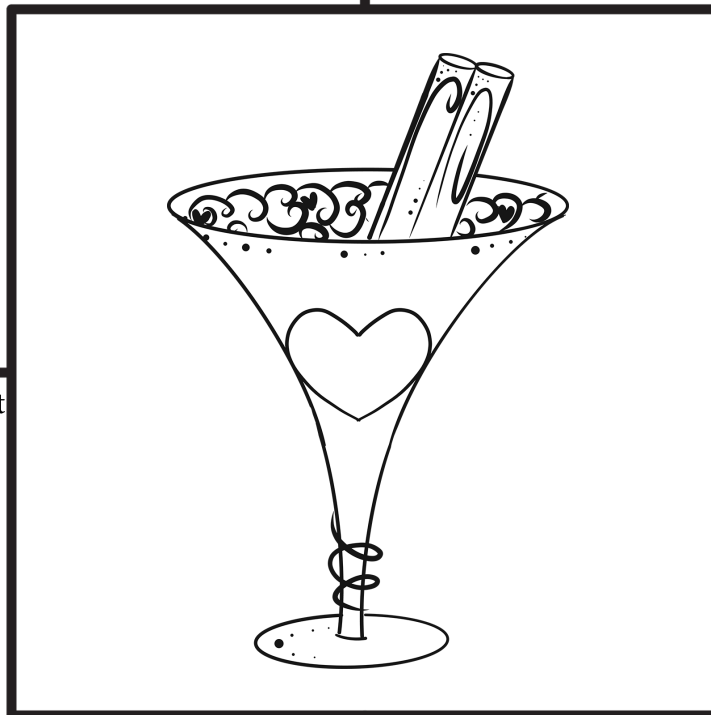

How is it made, and what are its main ingredients?

Is it served by itself or with something else (if so, what)?

Christmas Foods Around the World

Rosca de reyes

In what country/countries is it part of Christmas?

How is it part of Christmas traditions?

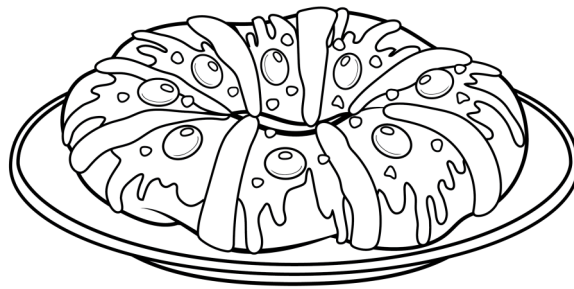

How is it made, and what are its main ingredients?

Is it served by itself or with something else (if so, what)?

Christmas Foods Around the World

Solyanka

In what country/countries is it part of Christmas?

How is it part of Christmas traditions?

How is it made, and what are its main ingredients?

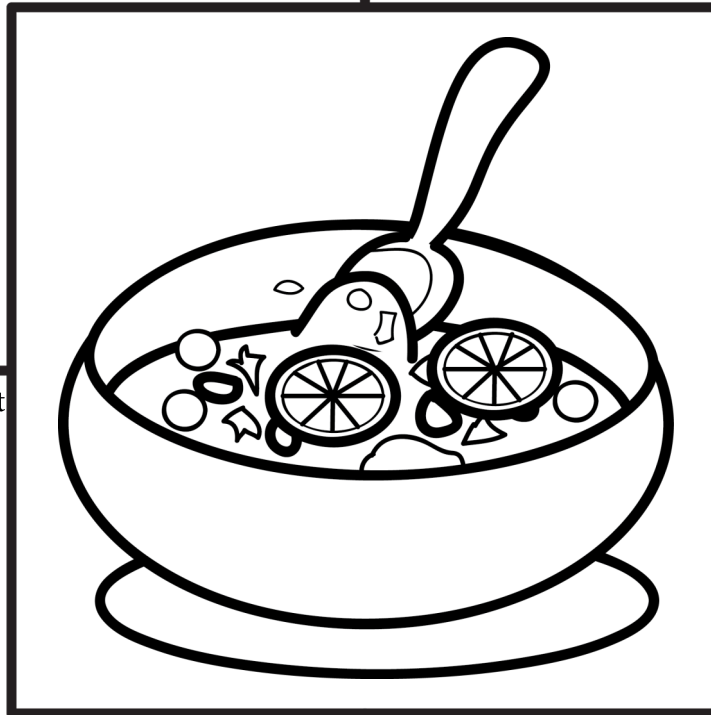

Is it served by itself or with something else (if so, what)?

Christmas Foods Around the World

Speculaas

In what country/countries is it part of Christmas?

How is it part of Christmas traditions?

How is it made, and what are its main ingredients?

Is it served by itself or with something else (if so, what)?

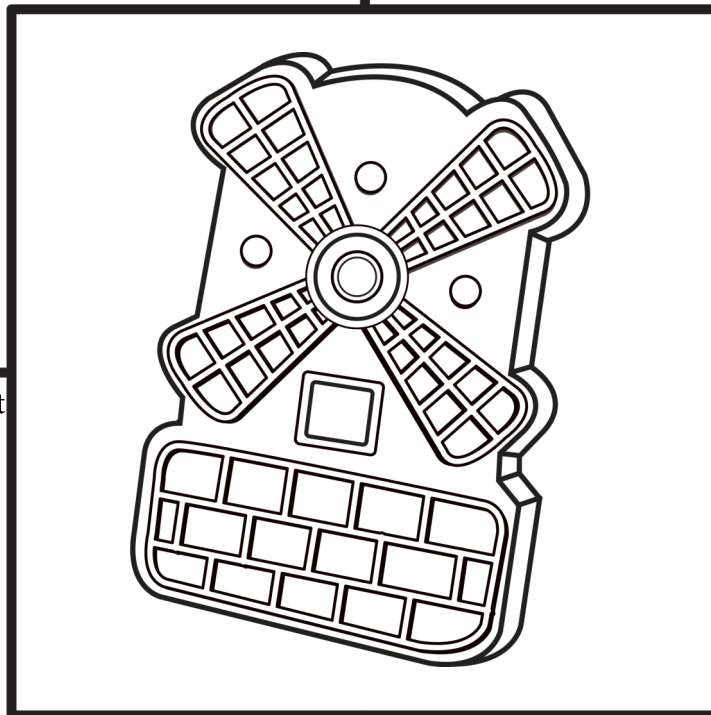

Christmas Foods Around the World

Springerle

In what country/countries is it part of Christmas?

How is it part of Christmas traditions?

How is it made, and what are its main ingredients?

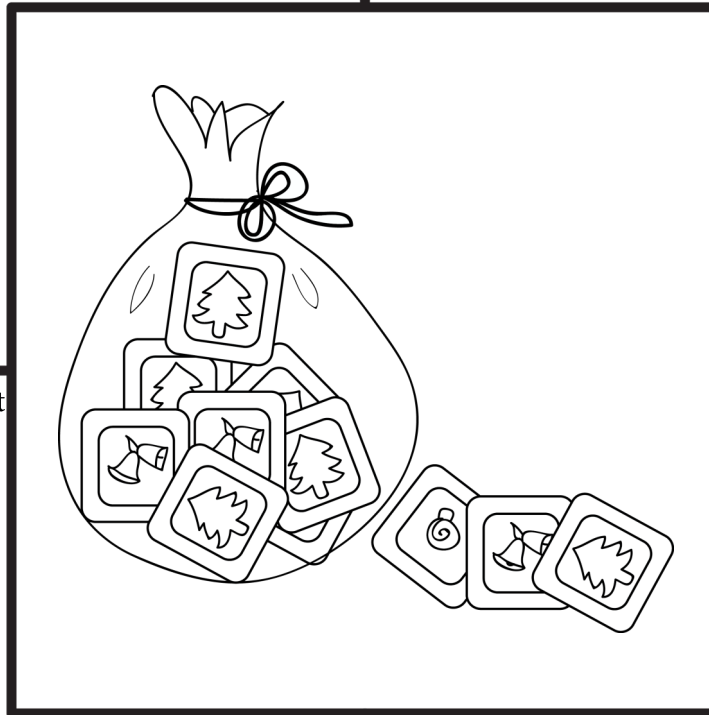

Is it served by itself or with something else (if so, what)?

Christmas Foods Around the World

Spring Rolls

In what country/countries is it part of Christmas?

How is it part of Christmas traditions?

How is it made, and what are its main ingredients?

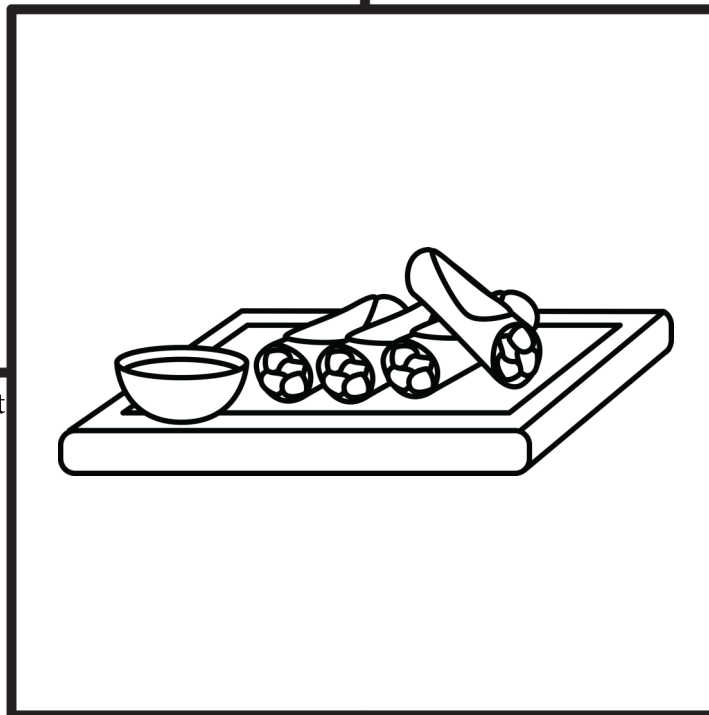

Is it served by itself or with something else (if so, what)?

Christmas Foods Around the World

Stollen

In what country/countries is it part of Christmas?

How is it part of Christmas traditions?

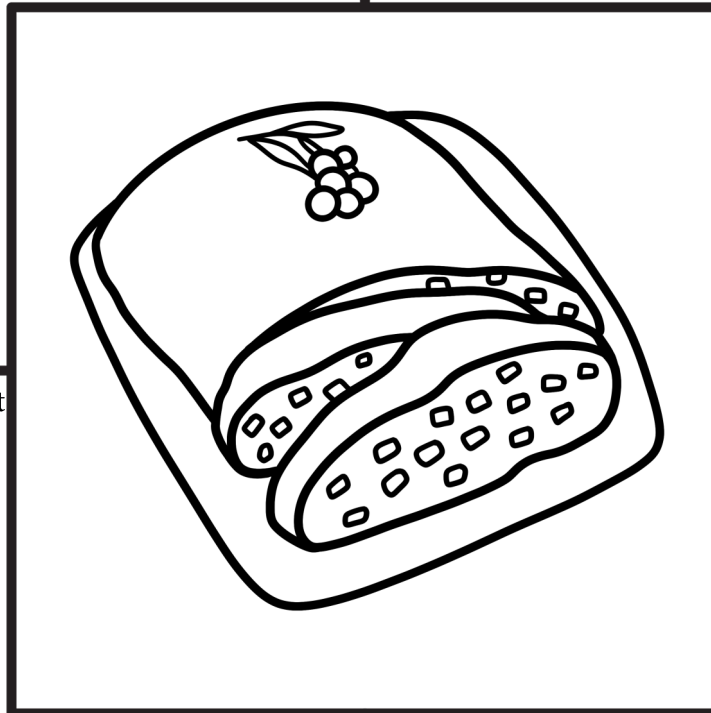

How is it made, and what are its main ingredients?

Is it served by itself or with something else (if so, what)?

Christmas Foods Around the World

Sukuma

In what country/countries is it part of Christmas?

How is it part of Christmas traditions?

How is it made, and what are its main ingredients?

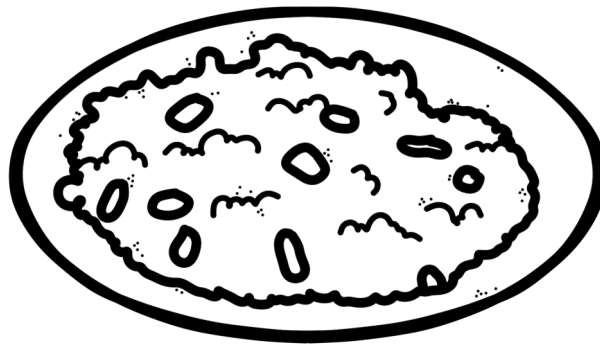

Is it served by itself or with something else (if so, what)?

Christmas Foods Around the World

Tamales

In what country/countries is it part of Christmas?

How is it part of Christmas traditions?

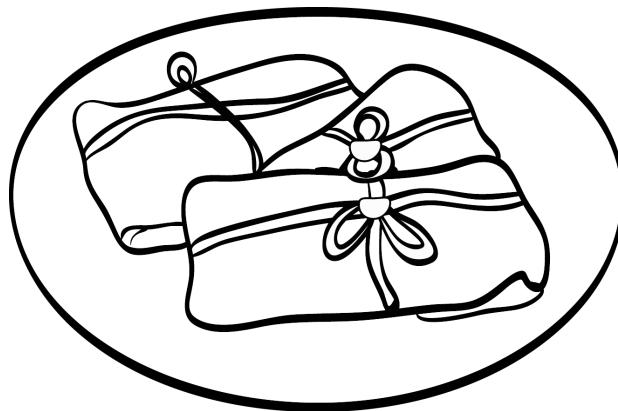

How is it made, and what are its main ingredients?

Is it served by itself or with something else (if so, what)?

Christmas Foods Around the World

Tapas

In what country/countries is it part of Christmas?

How is it part of Christmas traditions?

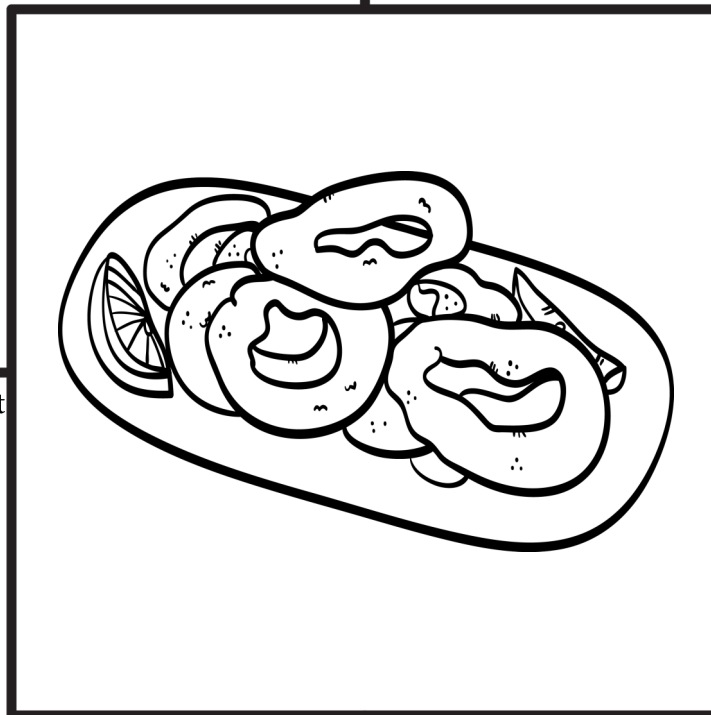

How is it made, and what are its main ingredients?

Is it served by itself or with something else (if so, what)?

Christmas Foods Around the World

Torrone

In what country/countries is it part of Christmas?

How is it part of Christmas traditions?

How is it made, and what are its main ingredients?

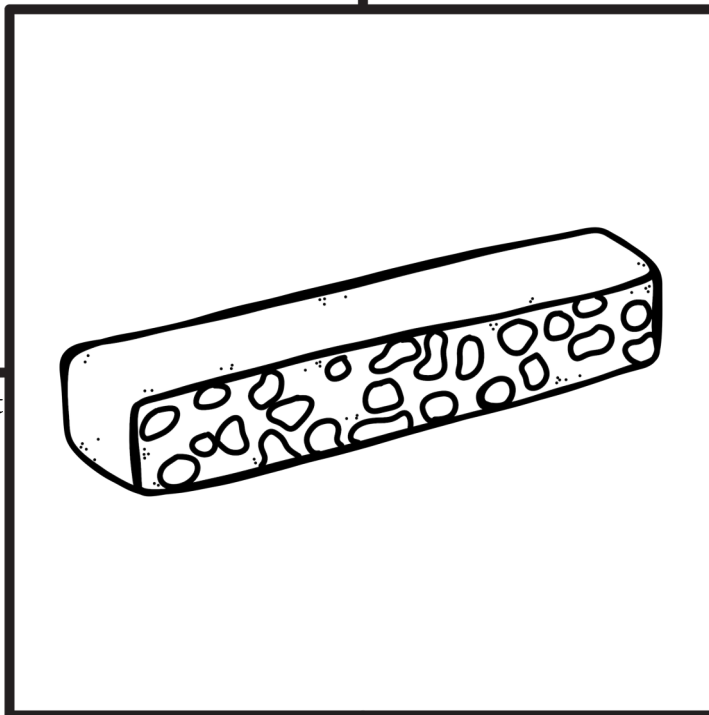

Is it served by itself or with something else (if so, what)?

Christmas Foods Around the World

Tourtière

In what country/countries is it part of Christmas?

How is it part of Christmas traditions?

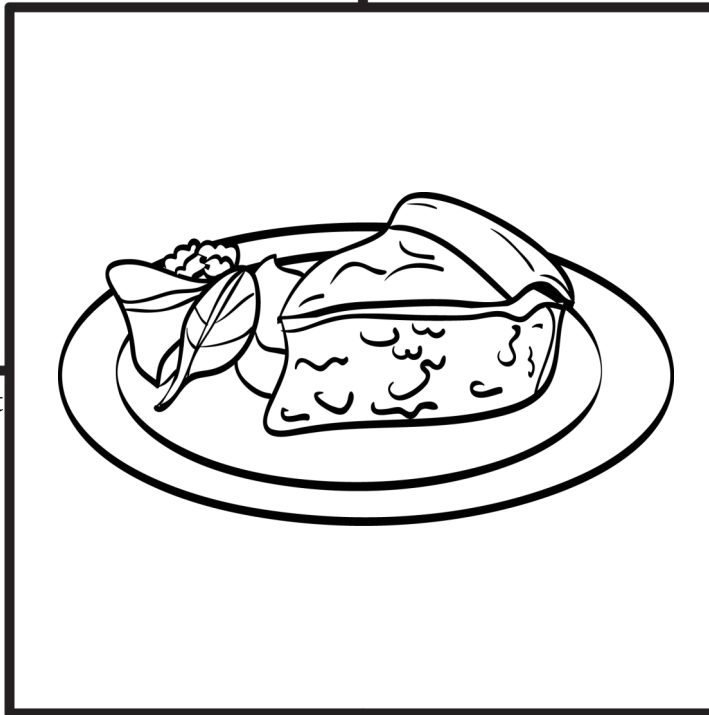

How is it made, and what are its main ingredients?

Is it served by itself or with something else (if so, what)?

Christmas Foods Around the World

Trifle

In what country/countries is it part of Christmas?

How is it part of Christmas traditions?

How is it made, and what are its main ingredients?

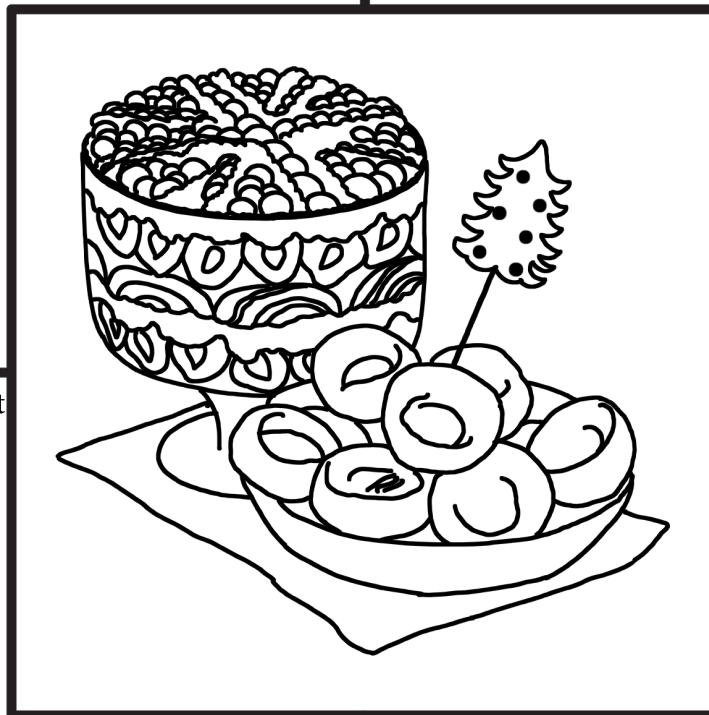

Is it served by itself or with something else (if so, what)?

Christmas Foods Around the World

Turrón

In what country/countries is it part of Christmas?

How is it part of Christmas traditions?

How is it made, and what are its main ingredients?

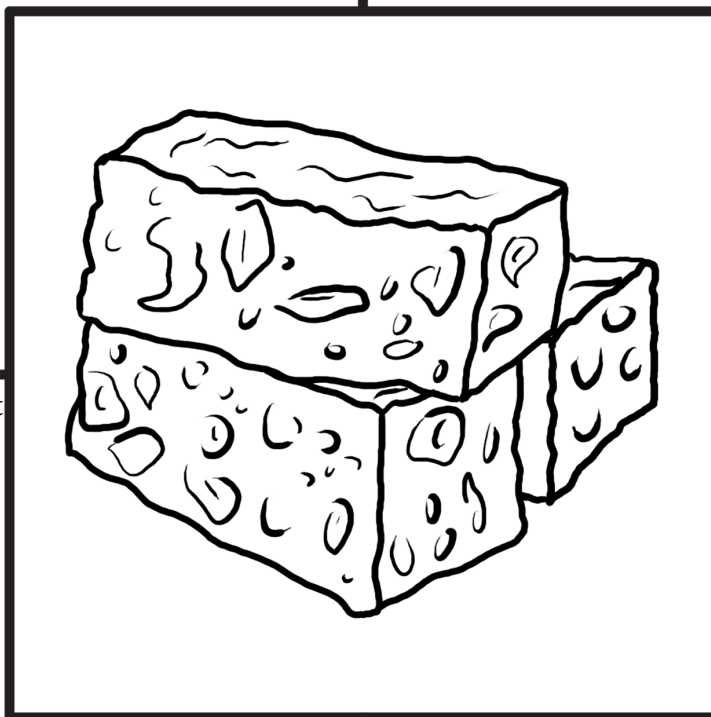

Is it served by itself or with something else (if so, what)?

Christmas Foods Around the World

Ugali

In what country/countries is it part of Christmas?

How is it part of Christmas traditions?

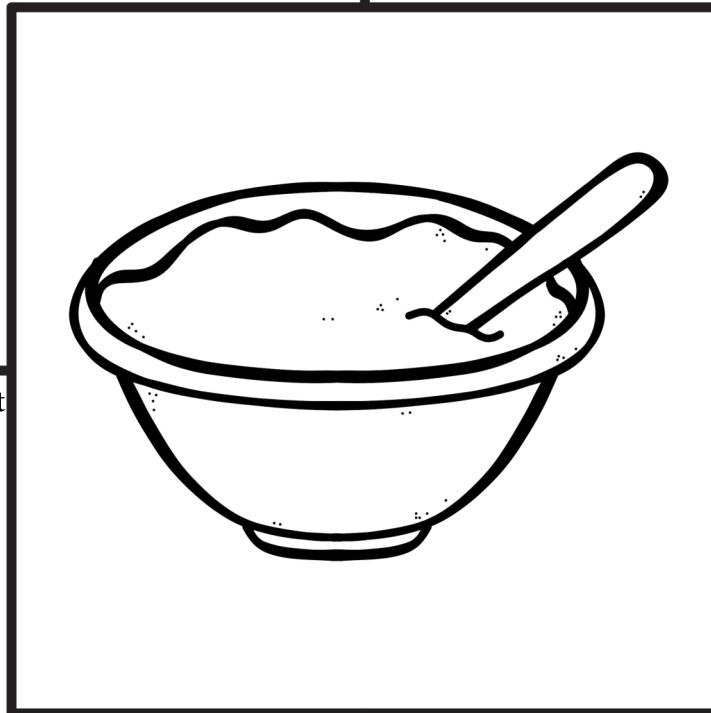

How is it made, and what are its main ingredients?

Is it served by itself or with something else (if so, what)?

Christmas Foods Around the World

Vzvar

In what country/countries is it part of Christmas?

How is it part of Christmas traditions?

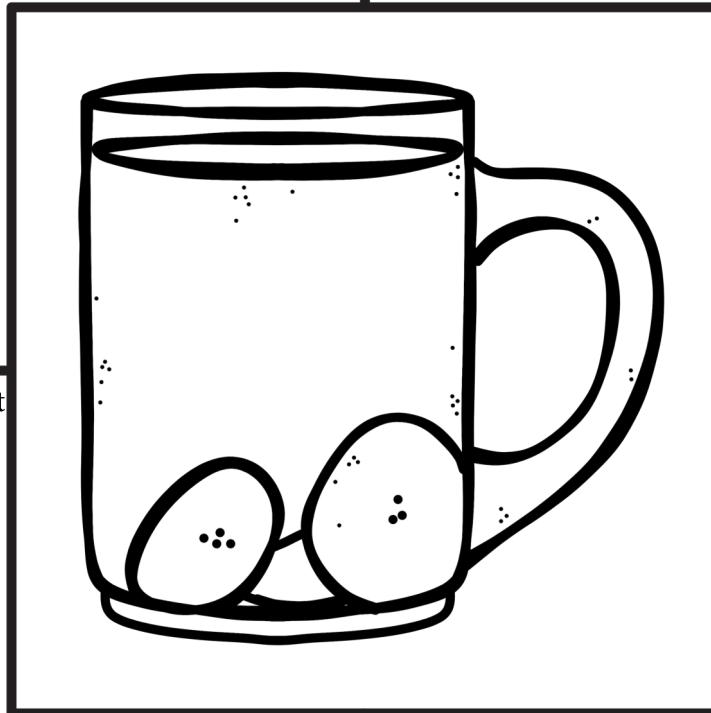

How is it made, and what are its main ingredients?

Is it served by itself or with something else (if so, what)?

Christmas Foods Around the World

Yorkshire Pudding

In what country/countries is it part of Christmas?

How is it part of Christmas traditions?

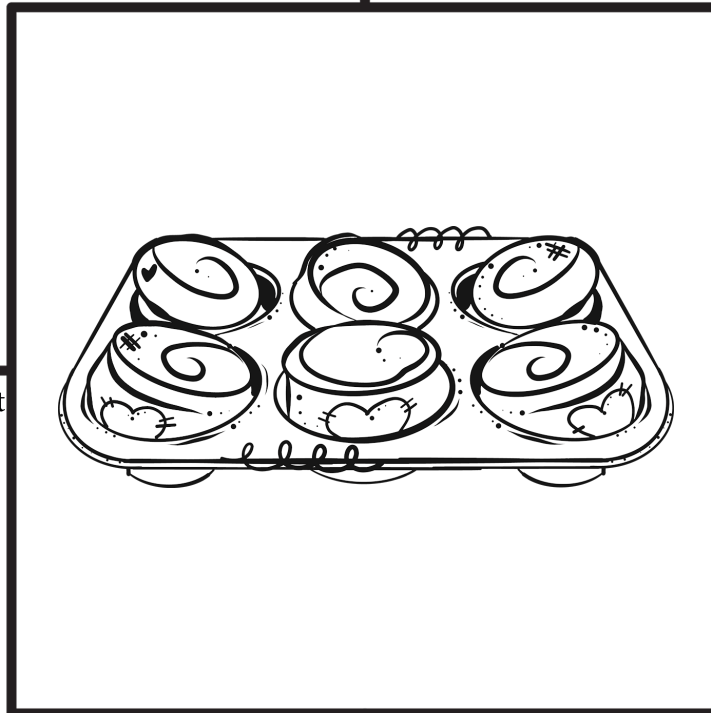

How is it made, and what are its main ingredients?

Is it served by itself or with something else (if so, what)?

Christmas Foods Around the World

Zimtstern

In what country/countries is it part of Christmas?

How is it part of Christmas traditions?

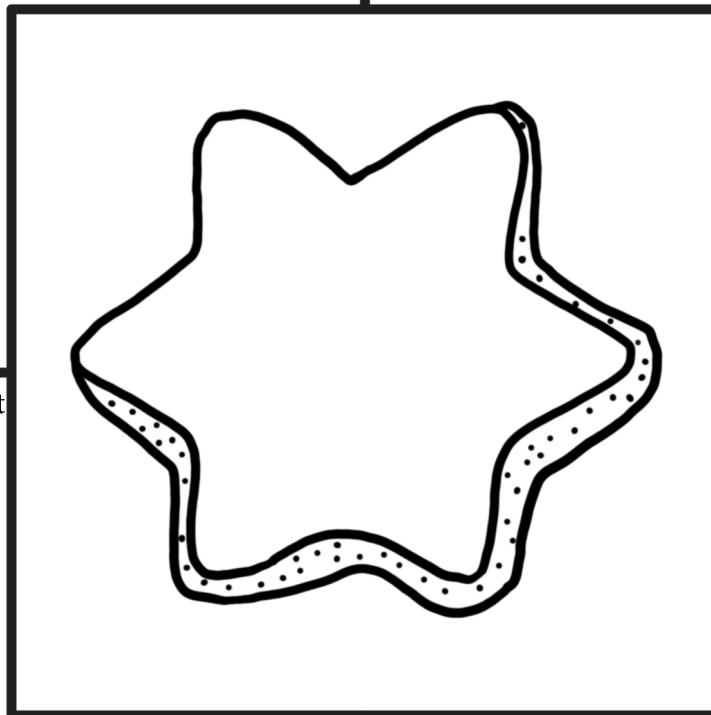

How is it made, and what are its main ingredients?

Is it served by itself or with something else (if so, what)?



Thank you for downloading my product! I pray it is a blessing to you and your family. If you'd like to view more of my products and freebies, you'll find them at WriteBonnieRose.com. I am adding new material almost every week, so please check back often or sign up to receive my newsletter so you don't miss a thing.

At WriteBonnieRose.com, you'll find:

- Resources for Teaching Kids About the Persecuted Church and Unreached People Groups
- Copywork
- History Resources and Printables
- Holiday Resources and Printables
- Coloring Pages
- Notebooking Pages
- Timeline Worksheets and Resources
- Short Stories for Kids
- Writing Opportunities
- How to Write for Homeschoolers

I'd love to connect with you! In addition to my website, you can find me on:

[Teachers Pay Teachers](#)

[Facebook](#)

[Pinterest](#)

[Twitter](#)

[LinkedIn](#)

